

# KRAMER



## USER MANUAL

**MODEL:**

**WP-20**

Wall Plate



## WP-20 Quick Start Guide

This guide helps you install and use your **WP-20** for the first time.

Go to [www.kramerav.com/downloads/WP-20](http://www.kramerav.com/downloads/WP-20) to download the latest user manual and check if firmware upgrades are available.

Scan for full manual

### Step 1: Check what's in the box

☑ WP-20 Wall plate

☑ 1 Power supply (12V DC)

☑ 1 Quick start guide

### Step 2: Get to know your WP-20

US Version

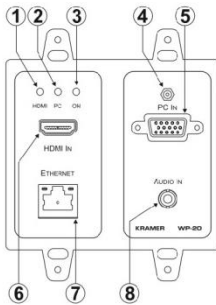

EU / UK Version

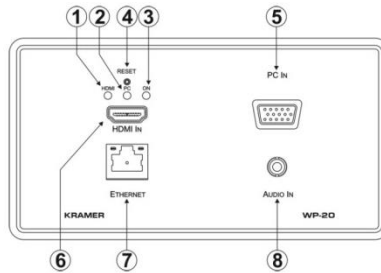

#	Feature	Function
1	<i>HDMI</i> LED	When HDMI is selected: Lights orange when external audio is selected. Lights green when embedded audio is selected. LED is off when HDMI is not selected.
2	<i>PC Graphics</i> LED	When PC input is selected: Lights orange when external audio is selected. Lights green when there is no audio. LED is off when the PC input is not selected
3	<i>ON</i> LED	The LED indicates the following: Lights green – power is provided by a power adapter. Lights orange – power is provided by PoE.
4	<i>RESET</i> Button	Short press to reset the device. Long press (5 seconds) to reset the device to factory default parameters.
5	<i>PC IN</i> Input Connector	Connect to the PC graphics source (for example, a laptop).
6	<i>HDMI IN</i> Input Connector	Connect to an HDMI source (for example, a Blu-ray disk player).
7	<i>ETHERNET</i> RJ-45 Connector	Connect to the Ethernet LAN.
8	<i>AUDIO IN</i> 3.5mm Mini Jack	Connect to the unbalanced, stereo audio source (for example, the audio output of the laptop).

### US Version

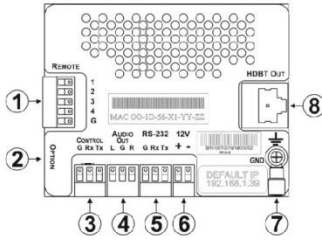

### EU / UK Version

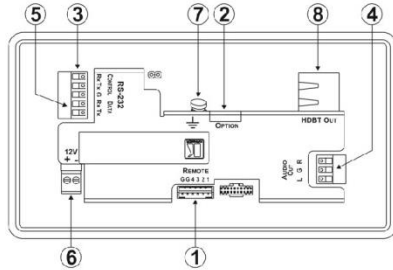

#	Feature	Function
1	REMOTE 5-pin Terminal Block	Connect to the remote, contact-closure switches for remote control (see Step 8).
2	OPTION 4-way DIP-switch	Switches for setting the device behavior (see Step 4).
3	CONTROL 3-pin Terminal Block	Connect to the serial controller to control the WP-20 (for example, a PC).
4	AUDIO OUT 3-pin Terminal Block	Connect to the unbalanced, stereo audio acceptor (for example, amplified speakers).
5	RS-232 3-pin Terminal Block	Connect to the PC to transfer data via RS-232 (for example, a serial controller for a remote device).
6	12V DC Connector	Connect to the included power supply. Not needed on the WP-20 if there is a PoE provider over HDBaseT.
7	GND Terminal	Connect to the common ground (optional).
8	HDBT OUT RJ-45 TP Connector	Connect to a compatible HDBT TP switcher or receiver (for example, the TP-780Rrx).

## Step 3: Connect the inputs

Always switch OFF the power on each device before connecting it to your WP-20. For best results, we recommend that you always use Kramer high-performance cables to connect AV equipment to the WP-20.

### RJ-45 Pinout:

For the Ethernet connector, see the wiring diagram below.

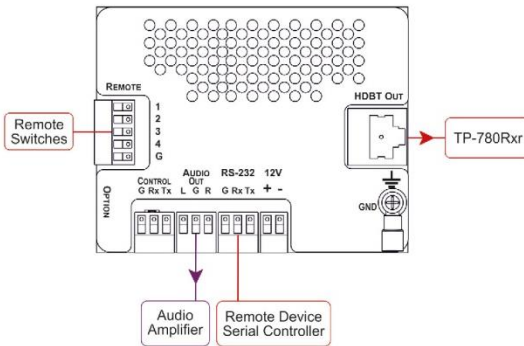

PIN EIA / TIA 568B	
PIN	Wire Color
1	Orange / White
2	Orange
3	Green / White
4	Blue
5	Blue / White
6	Green
7	Brown / White
8	Brown

## Step 4: Set the DIP switches

### Video Switching Selection

DIP-switch 1	DIP-switch 2	Video Input Selection
Off	Off	Automatic – Last connected. Where more than one source is connected, the last source has priority.
Off	On	Automatic – Priority selection. HDMI 1 → PC IN.
On	Off	Manual
On	On	Manual

### Audio Switching Selection

DIP-switch 3	DIP-switch 4	Audio Input Selection
Off	Off	Automatic – Priority selection. Embedded HDMI → analog Audio In.
Off	On	Automatic – Priority selection. Analog Audio In → embedded HDMI.
On	Off	Embedded HDMI
On	On	Analog Audio In

## Step 5: Connect the power

If the device is not powered via HDBT PoE, connect the 12V power supply to the **WP-20** and plug the power supply into the mains power.

### Safety Instructions



- Caution:** There are no operator serviceable parts inside the unit.  
**Warning:** Use only the Kramer Electronics power adapter that is provided with the unit.  
**Warning:** Disconnect the power and unplug the unit from the wall before installing.  
 See [www.kramerAV.com](http://www.kramerAV.com) for updated safety information.

## Step 6: Install the WP-20

Mount the device in a suitable wall box. We recommend opening all holes in the walls of the box to assist in cooling the **WP-20**.

## Step 7: Connect the outputs

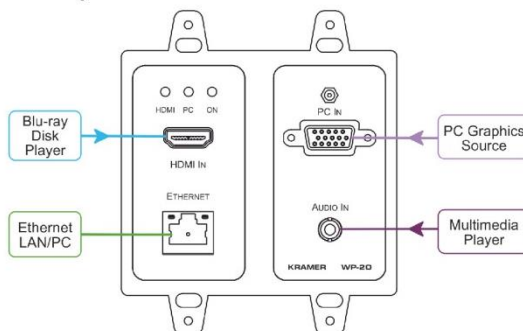

## Step 8: Operate the WP-20 via:

### Protocol 3000

#### Default IP Parameters

Parameter	Values	Default
Device Name	Any alphanumeric string up to 14 chars (can include hyphen, but not at the beginning or end)	KRAMER_
DHCP	ON/OFF	OFF
IP Address	Any valid IP address	192.168.1.39
Mask	Any valid network mask	255.255.0.0
Gateway	Any valid gateway address	192.168.0.1
TCP Port	0 to 65535	5000
UDP Port	0 to 65535	50000

#### Default Logon Credentials

Parameter	Values
Name	Admin
Password	Admin

### Remote contact-closure switches

#	Feature	Function
1	Input selection / VGA phase shift switch	Short press – Input toggle Long press – Adjusts the VGA phase shift
2	Step-in switch	Activates the step-in function if relevant
3	Analog audio output volume increase control	Short press – Increases the volume one step (0.5dB) Long press – Increases the volume from -83dB to +24dB in 10 seconds
4	Analog audio output volume decrease control	Short press – Decreases the volume one step (0.5dB) Long press – Decreases the volume from +24dB to -83dB in 10 seconds
G	Ground	Connect to the common side of the switches

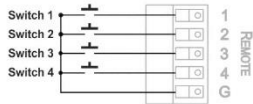

### Web Pages



# Contents

<b>1</b>	<b>Introduction</b>	<b>1</b>
<b>2</b>	<b>Getting Started</b>	<b>2</b>
2.1	Achieving the Best Performance	2
2.2	Safety Instructions DC	2
2.3	Shielded Twisted Pair/Unshielded Twisted Pair	3
2.4	Recycling Kramer Products	3
<b>3</b>	<b>Overview</b>	<b>4</b>
3.1	About HDBaseT™ Technology	5
<b>4</b>	<b>Defining the WP-20 Wall Plate</b>	<b>6</b>
<b>5</b>	<b>Connecting the WP-20</b>	<b>8</b>
5.1	Connecting the Remote Control Switches	10
5.2	Wiring the RJ-45 Connectors	11
<b>6</b>	<b>Principles of Operation</b>	<b>12</b>
6.1	Input Selection	12
6.2	Signal Loss and Unplugged Cable Timeouts	13
6.3	Audio Signal Control	13
6.4	VGA Phase Shift	14
<b>7</b>	<b>Operating the WP-20</b>	<b>15</b>
7.1	Selecting an Input Manually	15
7.2	Locking the EDID	15
7.3	Resetting the WP-20	15
7.4	Analog Audio Output Volume Control	16
<b>8</b>	<b>Configuring the WP-20</b>	<b>17</b>
8.1	Setting the Configuration DIP-switch	17
8.2	Video Switching Timeouts	18
<b>9</b>	<b>Operating the WP-20 Remotely Using the Embedded Web Pages</b>	<b>19</b>
9.1	Browsing the WP-20 Web Pages	19
9.2	Switching Page	23
9.3	Device Settings Page	24
9.4	Control Settings Page	26
9.5	Video and Audio Settings Page	28
9.6	Authentication Page	29
9.7	EDID Page	31
9.8	Firmware Upgrade	33
9.9	About Page	34
<b>10</b>	<b>Technical Specifications</b>	<b>35</b>
10.1	Default IP Parameters	36
10.2	Default RS-232 Communication Parameters	36
10.3	Default Logon Credentials	36
10.4	Supported HDMI Resolutions	37
10.5	Supported VGA Resolutions	38
<b>11</b>	<b>Default EDID</b>	<b>39</b>
11.1	HDMI	39
11.2	PC-UXGA	41
<b>12</b>	<b>Protocol 3000</b>	<b>43</b>
12.1	Understanding Protocol 3000	45

12.2	Kramer Protocol 3000 Syntax	46
12.3	Protocol 3000 Commands	47

## Figures

Figure 1:	WP-20 Wall Plate Front Panel	6
Figure 2:	WP-20E Wall Plate Front Panel	6
Figure 3:	WP-20 Wall Plate Rear Panel	7
Figure 4:	WP-20E Wall Plate Rear Panel	7
Figure 5:	Connecting the WP-20 Wall Plate	8
Figure 6:	Remote Switches Terminal Block	10
Figure 7:	The Configuration DIP-switch	17
Figure 8:	Entering Logon Credentials	20
Figure 9:	Default Page	20
Figure 10:	Save Configuration Progress	22
Figure 11:	Save Completion Message	22
Figure 12:	Switching Page	23
Figure 13:	Device Settings Page	24
Figure 14:	Control Settings Page	26
Figure 15:	Video and Audio Settings Page	28
Figure 16:	Authentication Page	29
Figure 17:	EDID Page	31
Figure 18:	Firmware Upgrade Page	33
Figure 19:	About Page	34

---

# 1 Introduction

Welcome to Kramer Electronics! Since 1981, Kramer Electronics has been providing a world of unique, creative, and affordable solutions to the vast range of problems that confront video, audio, presentation, and broadcasting professionals on a daily basis. In recent years, we have redesigned and upgraded most of our line, making the best even better!

Our 1,000-plus different models now appear in 14 groups that are clearly defined by function: GROUP 1: Distribution Amplifiers; GROUP 2: Switchers and Routers; GROUP 3: Control Systems; GROUP 4: Format/Standards Converters; GROUP 5: Range Extenders and Repeaters; GROUP 6: Specialty AV Products; GROUP 7: Scan Converters and Scalers; GROUP 8: Cables and Connectors; GROUP 9: Room Connectivity; GROUP 10: Accessories and Rack Adapters; GROUP 11: Sierra Video Products; GROUP 12: Digital Signage; GROUP 13: Audio; and GROUP 14: Collaboration.

Congratulations on purchasing your Kramer **WP-20** Wall Plate. This product, which incorporates HDMI™ technology, is ideal for:

- Display systems requiring simple, automatic input selection
- Multimedia and presentation source selection
- Video distribution in hotel rooms and schools

**Note:** All references in this manual to the **WP-20** in this manual also apply to the **WP-20E** European versions.



---

## 2 Getting Started

We recommend that you:

- Unpack the equipment carefully and save the original box and packaging materials for possible future shipment
- Review the contents of this user manual



Go to [www.kramerav.com/downloads/WP-20](http://www.kramerav.com/downloads/WP-20) to check for up-to-date user manuals, application programs, and to check if firmware upgrades are available (where appropriate).

### 2.1 Achieving the Best Performance

To achieve the best performance:

- Use only good quality connection cables (we recommend Kramer high-performance, high-resolution cables) to avoid interference, deterioration in signal quality due to poor matching, and elevated noise levels (often associated with low quality cables)
- Do not secure the cables in tight bundles or roll the slack into tight coils
- Avoid interference from neighboring electrical appliances that may adversely influence signal quality
- Position your **WP-20** away from moisture, excessive sunlight and dust



This equipment is to be used only inside a building. It may only be connected to other equipment that is installed inside a building.

### 2.2 Safety Instructions DC



**Caution:** There are no operator serviceable parts inside the unit

**Warning:** Use only the Kramer Electronics power supply that is provided with the unit

**Warning:** Disconnect the power and unplug the unit from the wall before installing

## 2.3 Shielded Twisted Pair/Unshielded Twisted Pair

Kramer engineers have developed special twisted pair cables to best match our digital twisted pair products; Kramer CAT 6 HDBaseT certified and CAT 7a cables significantly outperform regular CAT 6 and CAT 7a cables.

## 2.4 Recycling Kramer Products

The Waste Electrical and Electronic Equipment (WEEE) Directive 2002/96/EC aims to reduce the amount of WEEE sent for disposal to landfill or incineration by requiring it to be collected and recycled. To comply with the WEEE Directive, Kramer Electronics has made arrangements with the European Advanced Recycling Network (EARN) and will cover any costs of treatment, recycling and recovery of waste Kramer Electronics branded equipment on arrival at the EARN facility. For details of Kramer's recycling arrangements in your particular country go to our recycling pages at [www.kramerav.com/support/recycling/](http://www.kramerav.com/support/recycling/).

---

## 3 Overview

**WP-20** is a 4K UHD, HDBaseT active wall plate with Step-In auto switcher for HDMI, VGA and analog audio signals that supports resolutions up to 4K@60Hz (4:2:0) UHD. The device has EDID management, various control options and audio embedding. The unit is a fully-featured auto-switcher with the installation convenience and operational simplicity of a wall plate. **WP-20** is easy to configure, can be powered remotely over Ethernet (PoE) and is designed for any size room.

**WP-20** accepts an HDMI and PC graphics video input, an Ethernet signal, serial data, and an unbalanced stereo audio input (which is embedded into the output signal), and transmits the signal via HDBaseT (Twisted Pair) cable to a compatible receiver (for example, the **TP-789Rxr**). **WP-20** is a PoE (Power over Ethernet) receiver and can be powered by a compatible PoE provider, (for example, **PSE-1**).

**WP-20** supports a range of up to 130m (430ft) at normal mode (2K), up to 100m (330ft) at normal mode (4K @60Hz (4:2:0)); up to 180m (590ft) extended mode (1080p @60Hz @24bpp) when using **BC-UNIKAT** cables.



For optimum range and performance, use the recommended Kramer cables available at [www.kramerav.com/product/WP-20](http://www.kramerav.com/product/WP-20). Note that the transmission range depends on the signal resolution, graphics card and display used. The distance using non-Kramer CAT 5, CAT 6, and CAT 7 cables may not reach these ranges.

In particular **WP-20** features:

- Simple and Powerful Maestro Room Automation — Intuitive user interface enables you to fully automate your meeting room elements. Configure lights, shades, devices and more to be activated by an extensive range of triggers, including input/output connectivity, routing, and button pressing. By minimizing user intervention, Maestro room automation saves meeting prep time and minimizes human error before presentations.
- Support for 4K UHD, (data rate of up to 10.2Gbps)
- Automatic input selection based on priority selection or last connected input
- Manual input selection

- Automatic live input detection based on video clock presence
- Automatic analog audio detection and embedding
- Audio Only Mode – Play only audio without displaying video (shows a black screen).
- Power over Ethernet (PoE) Acceptor – Can be powered by a PoE provider. This allows a single cable to provide both a data connection and electrical power
- Control via Kramer Protocol 3000 and embedded web pages over a LAN
- HDTV support
- HDMI with Deep Color, x.v.Color™ and 3D
- HDCP compliancy—works with sources that support HDCP repeater mode
- I-EDIDPro™ Kramer Intelligent EDID Processing™ – Intelligent EDID handling & processing algorithm ensures Plug and Play operation for HDMI systems
- A lockable EDID
- Remote control via contact-closure switches
- Equalization and re-clocking of the data
- Support for digital audio formats
- Local Step-In Switching – Via contact closure.
- Availability in US and European versions

### 3.1 About HDBaseT™ Technology

HDBaseT™ is an advanced, all-in-one connectivity technology (supported by the HDBaseT Alliance). It is particularly suitable in the ProAV – and also the home – environment as a digital networking alternative, where it enables you to replace numerous cables and connectors by a single LAN cable used to transmit, for example, uncompressed, full high-definition video, audio, IR, as well as various control signals.



The products described in this user manual are HDBaseT certified.

## 4 Defining the WP-20 Wall Plate

Figure 1 and Figure 2 define the front panels of the WP-20 and the WP-20E.

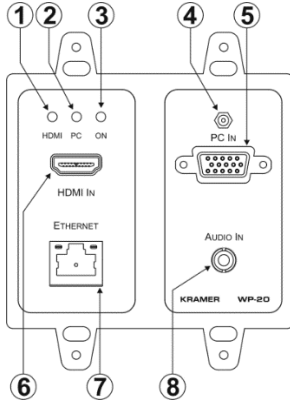

Figure 1: WP-20 Wall Plate Front Panel

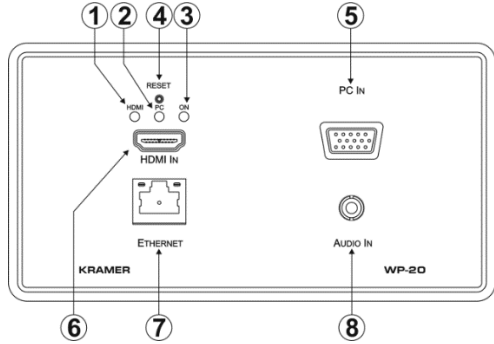

Figure 2: WP-20E Wall Plate Front Panel

#	Feature	Function
1	HDMI LED	When HDMI is selected: <ul style="list-style-type: none"> <li>Lights orange when external audio is selected</li> <li>Lights green when embedded audio is selected</li> <li>When HDMI is not selected the LED does not light</li> </ul>
2	PC Graphics LED	When PC input is selected: <ul style="list-style-type: none"> <li>Lights orange when external audio is selected.</li> <li>Lights green when there is no audio</li> <li>When the PC input is not selected the LED does not light</li> </ul>
3	ON LED	The LED indicates the following: <ul style="list-style-type: none"> <li>Lights green—power is provided by a power adapter</li> <li>Lights orange—power is provided by PoE</li> </ul>
4	Reset Button	Short press to reset the device, long press (5 seconds) to reset the device to factory default parameters
5	PC IN Input Connector	Connect to the PC graphics source, (for example, a laptop)
6	HDMI IN Input Connector	Connect to an HDMI source, (for example, a Blu-ray disk player)
7	ETHERNET RJ-45 Connector	Connect to the Ethernet LAN
8	AUDIO IN 3.5mm Mini Jack	Connect to the unbalanced, stereo audio source, (for example, the audio output of the laptop)

[Figure 3](#) and [Figure 4](#) define the rear panels of the **WP-20** and **WP-20E**.

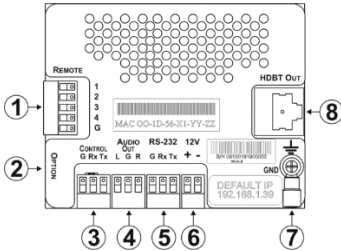

Figure 3: WP-20 Wall Plate Rear Panel

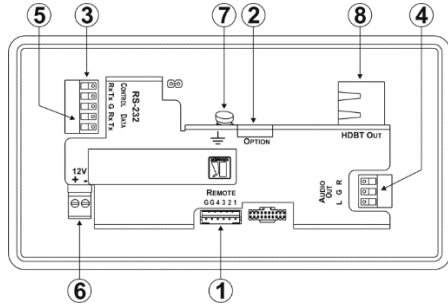

Figure 4: WP-20E Wall Plate Rear Panel

#	Feature	Function
1	<i>REMOTE</i> 5-pin Terminal Block	<ul style="list-style-type: none"> <li>Connect to the remote, contact-closure switches for remote control, (see <a href="#">Section 5.1</a>)</li> </ul>
2	<i>OPTION</i> 4-way DIP-switch	<ul style="list-style-type: none"> <li>Switches for setting the device behavior, (see <a href="#">Section 8.1</a>)</li> </ul>
3	<i>CONTROL</i> 3-pin Terminal Block	<ul style="list-style-type: none"> <li>Connect to the serial controller to control the WP-20, (for example, a PC)</li> </ul>
4	<i>AUDIO OUT</i> 3-pin Terminal Block	Connect to the unbalanced, stereo audio acceptor, (for example, amplified speakers)
5	<i>RS-232</i> 3-pin Terminal Block	Connect to the PC to transfer data via RS-232, (for example, a serial controller for a remote device)
6	12V DC Connector	Connect to the supplied power adapter. Not needed on the WP-20 if there is a PoE provider over HDBaseT
7	Earth Terminal	Connect to the common ground (optional)
8	<i>HDBT OUT</i> RJ-45 TP Connector	Connect to a compatible HDBT TP switcher or receiver (for example, the TP-780Rxr)

## 5 Connecting the WP-20



Always switch off the power to each device before connecting it to your **WP-20**. After connecting your **WP-20**, connect its power and then switch on the power to each device.

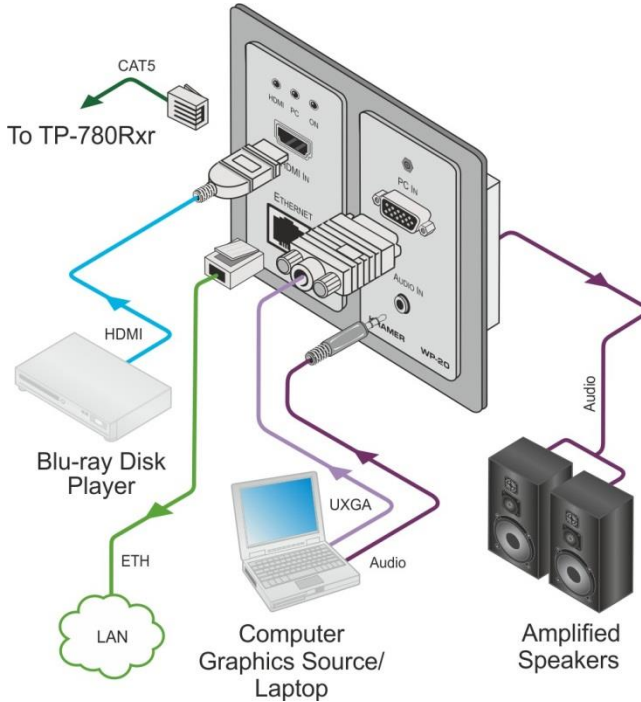

Figure 5: Connecting the WP-20 Wall Plate

**Note:** When the receiver in use does not support Ethernet, you can replace the left hand side faceplate with an optional part that does not have a cutout for the RJ-45 Ethernet connector.

**To connect the WP-20, as illustrated in the example in [Figure 5](#):**

1. Connect an HDMI source, (for example, a Blu-ray disk player) to the HDMI input.
1. Connect a PC graphics source, (for example, a laptop) to the PC In input.
2. Connect an unbalanced stereo audio source, (for example, the audio output from the laptop) to the AUDIO IN 3.5mm mini jack.
3. Connect the Ethernet RJ-45 connector on the front panel to the LAN.
4. Connect the HDBT OUT RJ-45 connector on the rear panel of the **WP-20** to an HDBT-compatible receiver (for example, the **TP-780Rxr**).
5. Connect the AUDIO OUT 3-pin terminal block on the rear panel of the **WP-20** to the unbalanced, stereo audio acceptor, (for example, a power amplifier with speakers).
6. Connect the REMOTE, 5-way terminal block to momentary, contact-closure switches, (see [Section 5.1](#)).
7. If the device is not connected to a PoE provider, connect the power adapter to the **WP-20** and to the mains power, (not shown in [Figure 5](#)).

**Note:** All LED supplies include a current limiting resistor and are designed to work with any standard LED.



## 5.1 Connecting the Remote Control Switches

You can connect remote, momentary-contact contact-closure switches to the terminal block on the rear panel of the **WP-20** to control various functions of the device.

[Figure 6](#) illustrates the connections from the terminal block to the contact-closure switches.

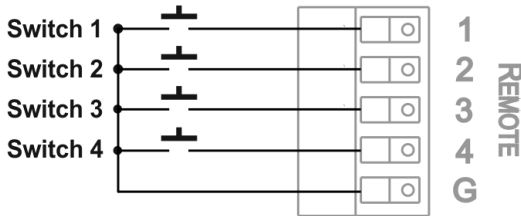

Figure 6: Remote Switches Terminal Block

#	Feature	Function
1	Input selection/VGA phase shift switch	Short press—Input toggle Long press—Adjusts the VGA phase shift, (see <a href="#">Section 6.4</a> )
2	Step-In switch	Activates the Step-In function
3	Analog audio output volume increase control, (see <a href="#">Section 7.4</a> )	Short press—Increases the volume one step (0.5dB) Long press—Increases the volume from -83dB to +24dB in 10 seconds
4	Analog audio output volume decrease control, (see <a href="#">Section 7.4</a> )	Short press—Decreases the volume one step (0.5dB) Long press—Decreases the volume from +24dB to -83dB in 10 seconds
G	Ground	Connect to the common side of the switches

## 5.2 Wiring the RJ-45 Connectors

This section defines the TP pinout, using a straight pin-to-pin cable with RJ-45 connectors.

EIA /TIA 568B	
PIN	Wire Color
1	Orange / White
2	Orange
3	Green / White
4	Blue
5	Blue / White
6	Green
7	Brown / White
8	Brown

Figure 5: TP PINOUT

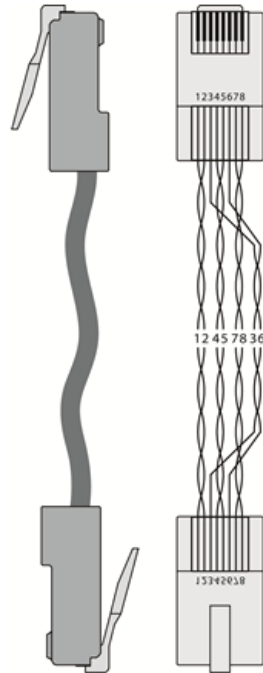

---

## 6 Principles of Operation

The **WP-20** selects video and audio inputs based on the rules described below.

### 6.1 Input Selection

The video mode selection is set by the DIP-switches (see [Section 8.1](#)) to either of the following modes:

- Manual
- Auto—Last connected or priority mode

In manual mode you select an input using, either the remote input selection switches, the Web-page interface, or P3000 commands, and switching occurs whether or not there is a live signal present on the input.

In auto mode, the switching selection is performed based on either last connected or priority input.

In last connected mode the **WP-20** selects the input based on which input was connected last. If the signal on this input is subsequently lost for any reason, the input with a live signal and which was also the last connected is selected automatically.

In priority mode, when the input sync signal is lost for any reason, the input with a live signal and next in priority is selected automatically. This priority is configurable; the default setting is HDMI > PC.

**Note:** In both last connected and priority modes, manually selecting an input using the remote input selection switches or the web pages (see [Section 9.2](#)) overrides the last automatic selection until the next connection event or power cycle.

## 6.2 Signal Loss and Unplugged Cable Timeouts

In both last connected and priority modes, when the input signal sync is lost (but the cable is not removed) there is a default delay (ten seconds for video, not applicable to the PC input, and five seconds for analog audio) before another input is automatically selected. When an input cable is removed, there is a delay before automatic switching takes place.

Both timeouts are configurable, (see [Section 8.1](#)).

**Note:** Analog audio is not output when there is no display connected. If a display is connected, analog audio is output even in the absence of a video signal.

## 6.3 Audio Signal Control

The Option DIP-switches 3 and 4 (see [Section 8.1](#)) control the manner in which audio is handled.

The following table describes which audio signal is embedded in the output.

Selected Video Input	HDMI Embedded Audio Detected	Analog Audio Detected	DIP-switch 3	DIP-switch 4	Audio on HDBT Output
VGA	N/A	Yes	N/A	N/A	Analog audio
VGA	N/A	No	N/A	N/A	No audio
HDMI	N/A	N/A	Manual	Embedded	Embedded audio
HDMI	N/A	N/A	Manual	Analog	Analog audio
HDMI	Yes	No	Auto	N/A	Embedded audio
HDMI	Yes	Yes	Auto	Embedded	Embedded audio
HDMI	Yes	Yes	Auto	Analog	Analog audio
HDMI	No	Yes	Auto	N/A	Analog audio
HDMI	No	No	Auto	N/A	No audio

When there is an audio signal but no video signal, the output is a black video screen in conjunction with the analog audio signal.

**Note:** The default timeout for audio switching when the input signal is lost is five seconds. This can be changed using either P3000 commands or the web pages.

## 6.4 VGA Phase Shift

To optimize phase on the input VGA signal, the VGA sampling phase can be shifted using the following methods:

- A long press on the PC IN select button on the front panel.  
Each long press steps the phase shift up one step, starting from 0 and going to 31. When set to 31, another long press steps the shift to 0
- A remote, contact-closure switch connected to pins 1 and G of the Remote terminal block.  
Each long press steps the phase shift up one step, starting from 0 and going to 31. When set to 31, another long press steps the shift to 0
- Using the web pages, (see [Section 9.2](#))
- Protocol 3000 commands over Ethernet or RS-232 (see [Section 12.3.4.1](#))

---

## 7 Operating the WP-20

Powering up the **WP-20** recalls the last settings from the non-volatile memory, (that is, the configuration of the device when it was powered down).

### 7.1 Selecting an Input Manually

Any of the following methods can be used to select an input:

- Protocol 3000 command, (see [Section 12](#))
- Remote contact-closure switch, (see [Section 5.1](#))
- Web pages, (see [Section 9](#))

### 7.2 Locking the EDID

To prevent the stored EDID (either default or read from a device) from being overwritten, you can lock the current EDID by either sending a Protocol 3000 command or by using the web pages.

**Note:** Do not power up the display before locking the EDID.

### 7.3 Resetting the WP-20

**To perform a soft reset of the WP-20:**

- Briefly press the Reset button.  
The device resets

**To reset the WP-20 to factory default parameters:**

- Press and hold the Reset button for five seconds.  
The device is reset to factory default parameters

## 7.4 Analog Audio Output Volume Control

The analog audio output volume can be controlled using remote, contact-closure switches connected to pins 3 and 4 of the Remote terminal block, (see [Section 5.1](#)). For volume control using the web pages, see [Section 9](#) and for using P3000 commands to control the volume see [Section 12.3.5](#).

The volume is adjustable from -83dB to +24dB in steps of 0.5dB.

---

# 8 Configuring the WP-20

## 8.1 Setting the Configuration DIP-switch

The 4-way dip-switch provides the ability to configure a number of device functions. A switch that is down is on; a switch that is up is off.

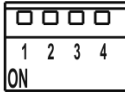

Figure 7: The Configuration DIP-switch

**Note:** After changing a dip-switch you must power cycle the device to implement the change.

### Video Switching Selection

DIP-switch 1	DIP-switch 2	Video Input Selection
Off	Off	Automatic—Last connected. Where more than one source is connected the last one connected has priority
Off	On	Automatic—Priority selection. HDMI 1 → PC IN
On	Off	Manual
On	On	Manual

### Audio Switching Selection

DIP-switch 3	DIP-switch 4	Audio Input Selection
Off	Off	Automatic—Priority selection. Embedded HDMI → analog Audio In
Off	On	Automatic—Priority selection. Analog Audio In → embedded HDMI
On	Off	Embedded HDMI
On	On	Analog Audio In



## 8.2 Video Switching Timeouts

When the **WP-20** is configured for auto switching, the timeouts, before a new input is automatically selected, can be changed as shown in the table below. (For the delay settings on the web page, see [Section 9.4](#).)

Timeout	Minimum Timeout	Default Timeout
Delay switching upon signal loss (signal off, 5V power on)	5 seconds	10 seconds
Delay switching upon cable unplug (signal off, power off)	0 seconds	0 seconds
Delay 5V power off upon signal loss (delay must be greater than "Delay switching upon signal loss")	5 seconds	900 seconds

**Note:** For audio auto-switching, the default timeout is 5 seconds, configurable by P3K commands.

---

## 9 Operating the WP-20 Remotely Using the Embedded Web Pages

The **WP-20** can be operated remotely using the embedded web pages. The web pages are accessed using a Web browser and an Ethernet connection.

Before attempting to connect:

- Ensure that your browser is supported (see [Section 10](#))
- Ensure that JavaScript is enabled



**Note:** The syntax of writing numbers with a prefix of zero is parsed as an octal number. For example, "0123" represents the decimal number 83.



**Note:** The web pages work with a minimum resolution of 1024 x 768.

### 9.1 Browsing the WP-20 Web Pages

**Note:** If a web page does not update correctly, clear your Web browser's cache by pressing CTRL+F5.

**To browse the WP-20 web pages:**

1. Open your Internet browser.
2. Type the IP number of the device (see [Section 10](#)) in the Address bar of your browser.



**Note:** If authentication is enabled, the following window appears ([Figure 8](#)) and you must enter the valid username and password to access the web pages. For default authentication details, see [Section 10](#).

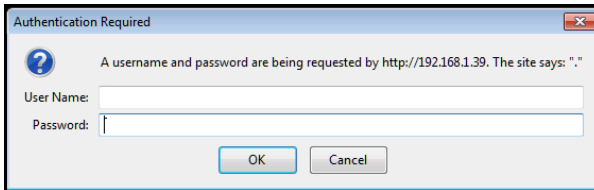

Figure 8: Entering Logon Credentials

Following a successful logon, the screen shown in [Figure 9](#) is displayed.

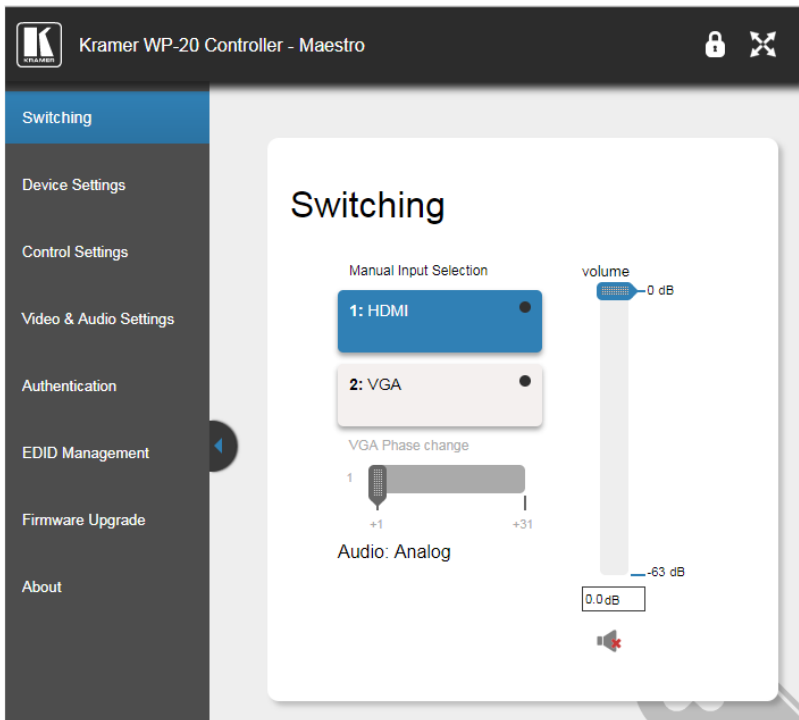

Figure 9: Default Page

The sections of the default page are described in the following table.

Item	Description
Navigation Pane	Click one of the buttons to select a page.
Hide/Reveal Button	Click the arrow to open or close the page navigation pane.
Security Indicator (upper right corner)	Closed lock icon = password security for the web pages is enabled. Open lock icon = password security for the web pages is disabled.

**Note:** When saving a configuration using Internet Explorer 11 press CTRL+S.

There are six web pages described in the following sections:

- Switching (see [Section 9.2](#))
- Device Settings (see [Section 9.3](#))
- Control Settings (see [Section 9.4](#))
- Video and Audio Settings (see [Section 9.5](#))
- Authentication (see [Section 9.6](#))
- EDID (see [Section 9.7](#))
- Firmware Upgrade (see [Section 9.8](#))
- About (see [Section 9.9](#))

### 9.1.1 Load/Save Configuration Facility

The Load/Save buttons on the Device Settings page (see section [9.3 Device Settings Page](#)) let you retrieve and save a configuration.

**To load a configuration:**

1. Click the Load button.  
A file browser window appears.
2. Browse to the required file and click Open.  
The configuration is retrieved, and a success message is displayed.

**To save the current configuration:**

1. Click the Save button.

The Save Configuration progress is displayed.

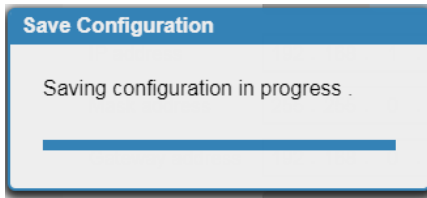

Figure 10: Save Configuration Progress

When saving is complete, a success message appears.

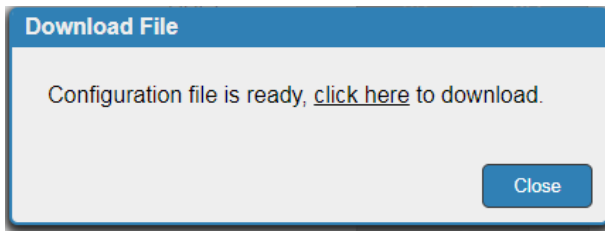

Figure 11: Save Completion Message

2. Click the message to download the configuration file to your computer

-OR-

Click Close to end the procedure without downloading the file.

## 9.2 Switching Page

The Switching page lets you select a video input manually and adjust the audio volume.

### Switching

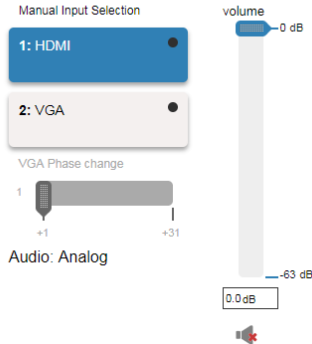

Figure 12: Switching Page

Item	Description
Live Signal Indicator (upper right corner of each input button)	Indicates whether there is a live signal on either of the inputs
HDMI Button	Click to select the HDMI input
VGA Button	Click to select the VGA input
VGA Phase change	Use the slider control to shift the VGA sampling phase
Audio Indicator	Indicates the source of the audio that is transmitted on the output
volume Slider	Click and slide up and down to increase or decrease the audio output volume
Mute Button	Click to mute or unmute the output audio

## 9.3 Device Settings Page

The Device Settings page lets you:

- View some of the device characteristics, (for example, model and firmware version)
- Edit IP settings, (for example, name and IP address)
- Reset the device to factory default settings

**Note:** After making any change to the parameters on the Device Settings page, you must power cycle the device to activate the changes.

The screenshot displays the 'Device Settings' web interface. At the top, it shows device characteristics: Unit name (WP-20-), Model (WP-20), Firmware version (2.11.47548), and Serial number. Below this is the 'Ethernet Settings' section, which includes a DHCP toggle (currently OFF), IP address (192.168.1.39), Mask address (255.255.0.0), and Gateway address (192.168.0.1). The Mac address is 00-1d-56-04-95-3a. There are also fields for UDP port (50000) and TCP port (5000). At the bottom, there are buttons for 'Load...', 'Save...', and 'Factory reset'.

Figure 13: Device Settings Page

Item	Description
Unit Name	The DNS name of the device. To set a new name, enter the new alphanumeric name and click Set. (For restrictions regarding the name, see <a href="#">Section 10.3</a> )
Information Section	Displays the device model, firmware version and serial number.
DHCP buttons	Click ON to turn DHCP on; click OFF to turn DHCP off
IP address	The IP address of the device. To set a new IP address, enter the new IP address and click Set
Mask address	The network mask of the device. To set a new mask, enter the new mask address and click Set
Gateway address	The network gateway for the device. To set a new network gateway, enter the new gateway address and click Set
Mac address	Information only
UDP Port	The UDP port number of the device. To set a new UDP port number, enter the new port number or use the spin controls and click Set
TCP Port	The TCP port number of the device. To set a new TCP port number, enter the new port number or use the spin controls and click Set
Set button	Click to store a changed parameter. Note: If you do not click the Set button, the new parameter is not stored
Factory reset button	Click to reset the device to factory default parameters. After the success message is displayed, power cycle the device
Load	Click to load a saved configuration (see section <a href="#">9.1.1</a> )
Save	Click to save the current configuration (see section <a href="#">9.1.1</a> )

**To reset the WP-20 to factory default parameters:**

1. Click the Factory reset button.  
The confirmation message is displayed.
2. Click OK to continue or Cancel to exit the procedure.
3. Click OK.  
The progress message is displayed.  
On completion, the success message is displayed.
4. Click OK.



## 9.4 Control Settings Page

The Control Settings page lets you:

- Configure serial communication via HDBaseT (see [section 9.4.1](#)).
- Configure Maestro automation (see [section 9.4.2](#)).

### Control Settings

#### HDBaseT Serial Settings

- HDBaseT Tunneling from Data Port
- WP-20 Control Through HDBaseT
- Remote Device Control over HDBaseT

#### Remote Device Control

Cancel Save All

The screenshot displays the 'Remote Device Control' configuration interface. It is divided into two main panels: 'Ports' and 'Editor'. The 'Ports' panel on the left contains three sections: 'Ports', 'Commands', and 'Actions'. The 'Ports' section shows a table with one entry: RS232, RS-232, 9600,1,None,8. The 'Commands' section has a '+ WOL' button and a text input field. The 'Actions' section has a table with columns 'Name' and '# Command rows'. The 'Editor' panel on the right has a 'Select an item to edit' message and a 'Triggers' section with a list of triggers and a corresponding 'Action to run' field. The triggers listed are: 5V On, 5V Off, HDMI On, HDMI Off, VGA On, VGA Off, First On, Last Off, and Stop In.

Name	Type	Details
* RS232	RS-232	9600,1,None,8

Name	# Command rows
------	----------------

Trigger	Action to run
5V On	
5V Off	
HDMI On	
HDMI Off	
VGA On	
VGA Off	
First On	
Last Off	
Stop In	

Figure 14: Control Settings Page

## 9.4.1 Configuring Serial Communication via HDBaseT

### To configure serial communication via the HDBaseT line:

- On the Control Settings page, in the HDBaseT Serial Settings area, select one of the following:
- **HDBaseT Tunneling from Data Port** – Route RS-232 data from the RS-232 DATA port to the HDBaseT port (pass-through mode)
- **WP-20 Control through HDBaseT** – Send a Step-In command from **WP-20** to a Step-In master over HDBaseT.
- **Remote Device Control over HDBaseT** – Send RS-232 commands over HDBaseT to turn on/off peripheral devices via a **Maestro** trigger.

## 9.4.2 Configuring Maestro Automation

The Remote Device Control section of the Control Settings page (Figure 14) is powered by Maestro and enables you to configure single-trigger room element automation scenarios.

Use the Control Settings page to access Kramer Maestro room automation. Maestro is a powerful tool that enables you to configure single-trigger room element automation scenarios without the need for complicated programming. To use room automation, you need to define triggers that, upon an event, will execute scripts which include a sequence of actions (commands, which can appear in different scenarios) that will be carried out via any defined ports.

For further details on how to use room automation, refer to the *Kramer Maestro User Manual*, available at [www.kramerav.com/downloads/WP-20](http://www.kramerav.com/downloads/WP-20).

## 9.5 Video and Audio Settings Page

The Video and Audio Settings page lets you modify the video, audio, HDCP and timeout parameters.

### Video & Audio Settings

#### Video

Video selection mode

Auto: Last connected

HIGH



Two buttons labeled 'HDMI' and 'VGA' are shown. The 'HDMI' button is highlighted with a white border, indicating it is the selected mode.

LOW

Drag to change the priority

Video auto switching priority

#### Audio

Audio selection mode

Auto: Priority switching

Current selection

Embedded

Audio only mode



Two buttons labeled 'Enabled' and 'Disabled' are shown. The 'Disabled' button is highlighted with a blue background, indicating it is the selected mode.

#### HDCP Support

HDMI 1



Two buttons labeled 'Enabled' and 'Disabled' are shown. The 'Enabled' button is highlighted with a blue background, indicating it is the selected mode.

#### Timeout

Delay switching upon signal loss for (leave 5v ON)



Two dropdown menus are shown. The first is labeled 'Video' and has '10 sec' selected. The second is labeled 'Audio' and has '5 sec' selected.

Delay switching input upon cable unplug for



Two dropdown menus are shown. The first is labeled 'Video' and has '0 sec' selected. The second is labeled 'Audio' and has '0 sec' selected.

Delay power off 5v upon signal loss for



A dropdown menu is shown with '900 sec' selected.

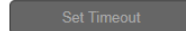

A button labeled 'Set Timeout' is shown.

Figure 15: Video and Audio Settings Page

Item		Description
Video	Video selection mode	Indicates the current video selection mode: Manual, Auto, or Auto: Last connected
	Video auto switching priority	Click either the HDMI or VGA button to select the priority selection when in auto mode
Audio	Audio selection mode	Indicates the current audio selection: Manual, Auto, or Auto: Last connected
	Current selection	Indicates the current audio selection
	Audio only mode	Enables/disables audio only mode
HDCP Support	HDMI 1	Enabled – HDCP support is dictated by the display Disabled – HDCP encrypted content is not passed.
Timeout	Delay switching upon signal loss for (leave 5V on)	Sets the delay for video (0 to 900 seconds) and audio (0 to 900 seconds) before switching (in auto mode) because of a signal loss on the currently selected input
	Delay switching input upon cable unplug for	Sets the delay for video (0 to 900 seconds) and audio (0 to 900 seconds) before switching (in auto mode) because the currently selected input cable is unplugged
	Delay power off 5V upon signal loss for	Sets the delay for turning off the 5V output (0 to 60,000 seconds) because of a signal loss on the currently selected input

**Note:** When enabling or disabling HDCP, disconnect and reconnect the HDMI cable between the source and **WP-20**.

## 9.6 Authentication Page

The Authentication page lets you assign or change logon authentication details.

**Authentication**

Activate Security  Enabled  Disabled

Change Password: Current

New

Retype New

Figure 16: Authentication Page

Item		Description
Activate Security		Click to enable/disable security settings. When enabled, the valid username and password must be provided to allow web page access
Change Password:	Current	Enter the current password
	New	Enter the new password, (up to 15 printable ASCII characters)
	Retype New	Retype the new password
	CHANGE	Click to save the new authentication details

**Note:** If the Authentication page is left open for more than five minutes additional windows may open. After entering your logon credentials, close the other windows.

## 9.7 EDID Page

The EDID page lets you copy EDID data to either or both of the inputs from any of the following sources:

- Output
- Input
- Default EDID
- EDID data file

From this page you can also lock the EDID on each input independently.

**Note:** Do not power up the display before locking the EDID.

### EDID Management

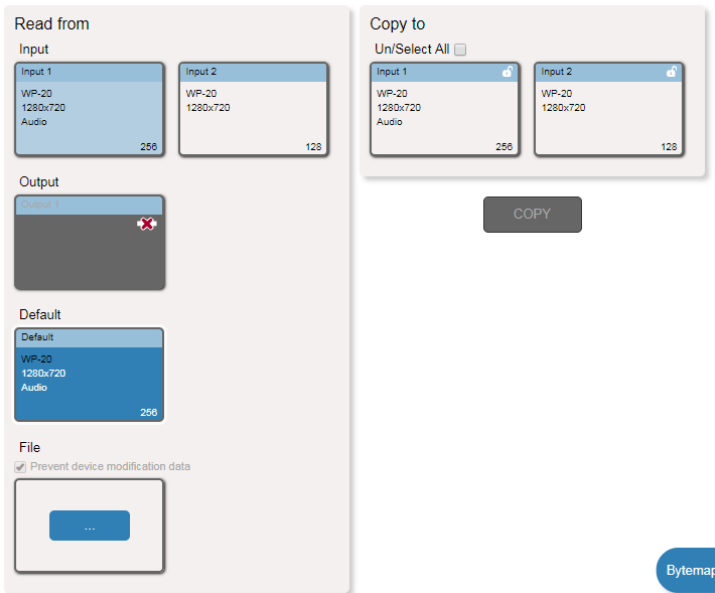

Figure 17: EDID Page

**Note:** The display is not updated automatically when the status of an EDID changes on the device caused by outputs being exchanged. Click Refresh to update the display, (see item 12 in the following table).

Item		Description
Read from	Input 1	Click to read the EDID from input 1 (HDMI)
	Input 2	Click to read the EDID from input 2 (VGA)
	Output	Click to read the EDID from the output
	DEFAULT	Click to read the default EDID
	File	Click to open the file browser to select an EDID file on your computer
Copy to	Un/Select All	Check to select both inputs
	Input 1 button	Click to select input 1 as the destination (HDMI)
	Input 2 button	Click to select input 2 as the destination (VGA)
COPY		Click to copy the EDID from the selected source to the selected destination
Bytemap		Click to open the bytemap

**To copy EDID data from a source to one or both inputs:**

1. Click one of the source buttons from which to read the EDID (default, output, input, or EDID file).  
The button changes color and the EDID summary information reflects the selection and EDID data.
2. Click one of the destination inputs, or select both inputs by checking the Inputs check-box.  
All selected input buttons change color and the EDID summary information reflects the selection and EDID data.
3. Click the Copy button.  
The EDID data is copied to the selected input(s) and the “EDID was copied” success message is displayed.
4. Click OK.

## 9.8 Firmware Upgrade

The Firmware Upgrade page lets you upgrade the **WP-20** firmware.

### Firmware Upgrade

Firmware version **2.11.47548**

Update Firmware



Figure 18: Firmware Upgrade Page



## 9.9 About Page

The **WP-20** About page displays the web page version and Kramer Electronics Ltd company details.



### WEB VERSION 3.0.7

Kramer Electronics Ltd.

3 Am VeOlamo St.

Jerusalem, Israel, 9546303

Tel: +972-73-2650200

Fax: +972-2-6535369

Email: [info@kramerel.com](mailto:info@kramerel.com)

Web: <http://www.kramerelectronics.com>

© 2019 - Kramer Electronics Ltd. all rights reserved.

Figure 19: About Page

# 10 Technical Specifications

INPUTS:	Video:	1 HDMI on an HDMI connector 1 VGA on a 15-pin HD (F) connector
	Audio:	1 Unbalanced stereo audio on a 3.5mm mini jack
OUTPUTS:	1 HDBaseT on an RJ-45 connector 1 Unbalanced stereo audio on a 3.5mm mini jack	
PORTS:	1 RS-232 3-pin terminal block 1 Ethernet on an RJ-45 connector	
CONTROLS:	Remote switches for input switching and volume control, reset switch	
STANDARDS:	HDMI with Deep Color, x.v.Color™ and 3D HDCP—works with sources that support HDCP repeater mode HDBT certified	
MAXIMUM ANALOG AUDIO LEVEL:	3.1V p-p	
THD:	0.013%	
SNR:	-70dB	
SUPPORTED WEB BROWSERS:	Windows 7 and higher: <ul style="list-style-type: none"> <li>• Internet Explorer (32/64 bit) version 11</li> <li>• Firefox version 30</li> <li>• Chrome version 35</li> </ul> MAC: <ul style="list-style-type: none"> <li>• Chrome version 35</li> <li>• Firefox version 27</li> <li>• Safari version 7</li> </ul>	
MAXIMUM TRANSMISSION DISTANCE:	180m (590ft) up to 1080p @60Hz @24bpp in extended mode 130m (430ft) up to 1080p @60Hz @36bpp in normal mode 100m (330ft) up to 4K @60Hz (4:2:0) in normal mode	
POWER CONSUMPTION:	12V DC, 850mA	
OPERATING TEMPERATURE:	0° to +40°C (32° to 104°F)	
STORAGE TEMPERATURE:	-40° to +70°C (-40° to 158°F)	
HUMIDITY:	10% to 90%, RHL non-condensing	
COOLING:	Convection	
ENCLOSURE TYPE:	Aluminum	
DIMENSIONS:	2 Gang USA 11.6 cm x 5.1cm x 11.4cm (4.57" x 2.01" x 4.49") W, D, H 2 Gang EU 15.1cm x 4.7cm x 8.6cm (5.94" x 1.85" x 3.39") W, D, H	
WEIGHT:	0.23kg (0.51lbs) approx.	
SHIPPING WEIGHT:	0.51kg (1.12lbs) approx.	
ENVIRONMENTAL REGULATORY COMPLIANCE:	Complies with appropriate requirements of RoHs and WEEE	
VIBRATION:	ISTA 1A in carton (International Safe Transit Association)	
COMPLIANCE STANDARDS:	CE	
INCLUDED ACCESSORIES:	Power adapter	
WARRANTY:	7 years parts and labor	

## 10.1 Default IP Parameters

Parameter	Values	Default
Device Name	Any alphanumeric string up to 14 chars (can include hyphen, but not at the beginning or end)	KRAMER_
DHCP	ON/OFF	OFF
IP Address	Any valid IP address	192.168.1.39
Mask	Any valid network mask	255.255.0.0
Gateway	Any valid gateway address	192.168.0.1
TCP Port	0 to 65535	5000
UDP Port	0 to 65535	50000

## 10.2 Default RS-232 Communication Parameters

Parameter	Values
Baud Rate	11520
Data Bits	1
Stop Bits	1
Parity	None
Command Format	ASCII

## 10.3 Default Logon Credentials

Parameter	Values
Name	Admin
Password	Admin

## 10.4 Supported HDMI Resolutions

Resolution	Refresh Rate (Hz)
640x480p	85Hz; 75Hz; 72Hz; 60Hz; 59.95Hz
720x480p	60Hz
720x480i	30Hz
720x576p	50Hz
800x600p	85Hz; 75Hz; 72Hz; 60Hz
848x480p	60Hz
852x480p	60Hz
1024x768p	85Hz; 75Hz; 70Hz; 60Hz
1152x864p	75Hz
1280x768p	60Hz
1280x800p	60Hz
1280x960	60Hz
1280x1024p	75Hz; 60Hz
1360x768p	60Hz
1366x768	60Hz; 50Hz
1400x1050p	60Hz
1440x900p	60Hz
1600x900p	60Hz
1600x1200p	60Hz
1680x1050p	60Hz
1920x1080p	50Hz; 60Hz; 30Hz; 24Hz;
1920x1080i	50Hz; 60Hz;
3840x2160	30Hz
4096x2160	30Hz

# 10.5 Supported VGA Resolutions

Resolution	Refresh Rate
640x480p	60Hz
720x480p	60Hz
800x600p	60Hz
848x480p	60Hz
1024x768p	60Hz
1152x864	75Hz
1280x720p	60Hz; 50Hz
1280x768	60Hz
1280x800	60Hz
1280x960p	60Hz
1280x1024p	60Hz
1360x768	60Hz;
1366x768	60Hz; 50Hz
1400x1050	60Hz
1440x900	60Hz
1920x1080p	60Hz
1920x1200	60Hz; 50Hz

---

# 11 Default EDID

Each input on the **WP-20** is loaded with a factory default EDID.

## 11.1 HDMI

### Monitor

Model name..... WP-20  
Manufacturer..... KMR  
Plug and Play ID..... KMR1200  
Serial number..... n/a  
Manufacture date..... 2015, ISO week 255  
Filter driver..... None  
-----  
EDID revision..... 1.3  
Input signal type..... Digital  
Color bit depth..... Undefined  
Display type..... RGB color  
Screen size..... 520 x 320 mm (24.0 in)  
Power management..... Standby, Suspend, Active off/sleep  
Extension blocs..... 1 (CEA-EXT)  
-----  
DDC/CI..... Not supported

### Color characteristics

Default color space..... Non-sRGB  
Display gamma..... 2.20  
Red chromaticity..... Rx 0.674 - Ry 0.319  
Green chromaticity..... Gx 0.188 - Gy 0.706  
Blue chromaticity..... Bx 0.148 - By 0.064  
White point (default)... Wx 0.313 - Wy 0.329  
Additional descriptors... None

### Timing characteristics

Horizontal scan range.... 30-83kHz  
Vertical scan range..... 56-76Hz  
Video bandwidth..... 170MHz  
CVT standard..... Not supported  
GTF standard..... Not supported  
Additional descriptors... None  
Preferred timing..... Yes  
Native/preferred timing.. 1280x720p at 60Hz (16:10)  
  Modeline..... "1280x720" 74.250 1280 1390 1430 1650 720 725 730 750 +hsync +vsync  
Detailed timing #1..... 1920x1080p at 60Hz (16:10)  
  Modeline..... "1920x1080" 148.500 1920 2008 2052 2200 1080 1084 1089 1125 +hsync +vsync

### Standard timings supported

720 x 400p at 70Hz - IBM VGA  
720 x 400p at 88Hz - IBM XGA2  
640 x 480p at 60Hz - IBM VGA  
640 x 480p at 67Hz - Apple Mac II  
640 x 480p at 72Hz - VESA  
640 x 480p at 75Hz - VESA  
800 x 600p at 56Hz - VESA  
800 x 600p at 60Hz - VESA  
800 x 600p at 72Hz - VESA  
800 x 600p at 75Hz - VESA  
832 x 624p at 75Hz - Apple Mac II  
1024 x 768i at 87Hz - IBM  
1024 x 768p at 60Hz - VESA  
1024 x 768p at 70Hz - VESA  
1024 x 768p at 75Hz - VESA  
1280 x 1024p at 75Hz - VESA  
1152 x 870p at 75Hz - Apple Mac II  
1280 x 1024p at 75Hz - VESA STD  
1280 x 1024p at 85Hz - VESA STD

1600 x 1200p at 60Hz - VESA STD  
1024 x 768p at 85Hz - VESA STD  
800 x 600p at 85Hz - VESA STD  
640 x 480p at 85Hz - VESA STD  
1152 x 864p at 70Hz - VESA STD  
1280 x 960p at 60Hz - VESA STD

EIA/CEA-861 Information

Revision number..... 3  
IT underscan..... Supported  
Basic audio..... Supported  
YCbCr 4:4:4..... Supported  
YCbCr 4:2:2..... Supported  
Native formats..... 1  
Detailed timing #1..... 1920x1080p at 60Hz (16:10)  
Modeline..... "1920x1080" 148.500 1920 2008 2052 2200 1080 1084 1089 1125 +hsync +vsync  
Detailed timing #2..... 1920x1080i at 60Hz (16:10)  
Modeline..... "1920x1080" 74.250 1920 2008 2052 2200 1080 1084 1094 1124 interlace +hsync  
+vsync  
Detailed timing #3..... 1280x720p at 60Hz (16:10)  
Modeline..... "1280x720" 74.250 1280 1390 1430 1650 720 725 730 750 +hsync +vsync  
Detailed timing #4..... 720x480p at 60Hz (16:10)  
Modeline..... "720x480" 27.000 720 736 798 858 480 489 495 525 -hsync -vsync

CE audio data (formats supported)

LPCM 2-channel, 16/20/24 bit depths at 32/44/48 kHz

CE video identifiers (VICs) - timing/formats supported

1920 x 1080p at 60Hz - HDTV (16:9, 1:1)  
1920 x 1080i at 60Hz - HDTV (16:9, 1:1)  
1280 x 720p at 60Hz - HDTV (16:9, 1:1) [Native]  
720 x 480p at 60Hz - EDTV (16:9, 32:27)  
720 x 480p at 60Hz - EDTV (4:3, 8:9)  
720 x 480i at 60Hz - Doublescan (16:9, 32:27)  
720 x 576i at 50Hz - Doublescan (16:9, 64:45)  
640 x 480p at 60Hz - Default (4:3, 1:1)  
NB: NTSC refresh rate = (Hz\*1000)/1001

CE vendor specific data (VSDB)

IEEE registration number. 0x000C03  
CEC physical address..... 1.0.0.0  
Maximum TMDS clock..... 165MHz

CE speaker allocation data

Channel configuration.... 2.0  
Front left/right..... Yes  
Front LFE..... No  
Front center..... No  
Rear left/right..... No  
Rear center..... No  
Front left/right center.. No  
Rear left/right center.. No  
Rear LFE..... No

Report information

Date generated..... 28/11/2017  
Software revision..... 2.90.0.1020  
Data source..... Real-time 0x0071  
Operating system..... 6.1.7601.2.Service Pack 1

Raw data

00,FF,FF,FF,FF,FF,00,2D,B2,00,12,00,00,00,00,FF,19,01,03,80,34,20,78,EA,B3,25,AC,51,30,B4,26,  
55,00,07,44,21,00,00,1E,00,00,00,FD,00,38,4C,1E,53,11,00,0A,20,20,20,20,20,00,00,00,FC,00,57,  
50,2D,32,30,0A,20,20,20,20,20,20,20,02,3A,80,18,71,38,2D,40,58,2C,45,00,07,44,21,00,00,1E,01,B6,  
02,03,1B,F1,23,09,07,07,48,10,05,84,03,02,07,16,01,65,03,0C,00,10,00,83,01,00,00,02,3A,80,18,71,  
38,2D,40,58,2C,45,00,07,44,21,00,00,1E,01,1D,80,18,71,1C,16,20,58,2C,25,00,07,44,21,00,00,9E,01,  
1D,00,72,51,DO,1E,20,6E,28,55,00,07,44,21,00,00,1E,8C,0A,D0,8A,20,E0,2D,10,10,3E,96,00,07,44,21,  
00,00,18,00,47

## 11.2 PC-UXGA

### Monitor

Model name..... WP-20  
Manufacturer..... KMR  
Plug and Play ID..... KMR1200  
Serial number..... n/a  
Manufacture date..... 2015, ISO week 255  
Filter driver..... None

EDID revision..... 1.3  
Input signal type..... Analog 0.700,0.000 (0.7V p-p)  
Sync input support..... Separate, Composite, Sync-on-green  
Display type..... RGB color  
Screen size..... 520 x 320 mm (24.0 in)  
Power management..... Standby, Suspend, Active off/sleep  
Extension blocs..... None

DDC/CI..... Not supported

### Color characteristics

Default color space..... sRGB  
Display gamma..... 2.20  
Red chromaticity..... Rx 0.674 - Ry 0.319  
Green chromaticity..... Gx 0.188 - Gy 0.706  
Blue chromaticity..... Bx 0.148 - By 0.064  
White point (default).... Wx 0.313 - Wy 0.329  
Additional descriptors... None

### Timing characteristics

Horizontal scan range.... 30-83kHz  
Vertical scan range..... 56-76Hz  
Video bandwidth..... 170MHz  
CVT standard..... Not supported  
GTF standard..... Not supported  
Additional descriptors... None  
Preferred timing..... Yes  
Native/preferred timing.. 1280x720p at 60Hz (16:10)  
  Modeline..... "1280x720" 74.250 1280 1390 1430 1650 720 725 730 750 +hsync +vsync  
Detailed timing #1..... 1920x1080p at 60Hz (16:10)  
  Modeline..... "1920x1080" 148.500 1920 2008 2052 2200 1080 1084 1089 1125 +hsync +vsync

### Standard timings supported

720 x 400p at 70Hz - IBM VGA  
720 x 400p at 88Hz - IBM XGA2  
640 x 480p at 60Hz - IBM VGA  
640 x 480p at 67Hz - Apple Mac II  
640 x 480p at 72Hz - VESA  
640 x 480p at 75Hz - VESA  
800 x 600p at 56Hz - VESA  
800 x 600p at 60Hz - VESA  
800 x 600p at 72Hz - VESA  
800 x 600p at 75Hz - VESA  
832 x 624p at 75Hz - Apple Mac II  
1024 x 768i at 87Hz - IBM  
1024 x 768p at 60Hz - VESA  
1024 x 768p at 70Hz - VESA  
1024 x 768p at 75Hz - VESA  
1280 x 1024p at 75Hz - VESA  
1152 x 870p at 75Hz - Apple Mac II  
1280 x 1024p at 75Hz - VESA STD  
1280 x 1024p at 85Hz - VESA STD  
1600 x 1200p at 60Hz - VESA STD  
1024 x 768p at 85Hz - VESA STD  
800 x 600p at 85Hz - VESA STD  
640 x 480p at 85Hz - VESA STD  
1152 x 864p at 70Hz - VESA STD  
1280 x 960p at 60Hz - VESA STD

### Report information



Date generated..... 28/11/2017  
Software revision..... 2.90.0.1020  
Data source..... Real-time 0x0021  
Operating system..... 6.1.7601.2.Service Pack 1

Raw data

00,FF,FF,FF,FF,FF,FF,00,2D,B2,00,12,00,00,00,00,FF,19,01,03,6E,34,20,78,EE,B3,25,AC,51,30,B4,26,  
10,50,54,FF,FF,80,81,8F,81,99,A9,40,61,59,45,59,31,59,71,4A,81,40,01,1D,00,72,51,D0,1E,20,6E,28,  
55,00,07,44,21,00,00,1E,00,00,00,FD,00,38,4C,1E,53,11,00,0A,20,20,20,20,20,20,00,00,00,FC,00,57,  
50,2D,32,30,0A,20,20,20,20,20,20,02,3A,80,18,71,38,2D,40,58,2C,45,00,07,44,21,00,00,1E,00,C5

## 12 Protocol 3000

The **WP-20** can be operated using the Kramer Protocol 3000 serial commands. The command framing varies according to how you interface with the **WP-20**. For example, a basic video input switching command that routes a layer 1 video signal to HDBT out 1 from HDMI input 2 (`ROUTE 1, 1, 2`), is entered as follows:

- Terminal communication software, such as Hercules:

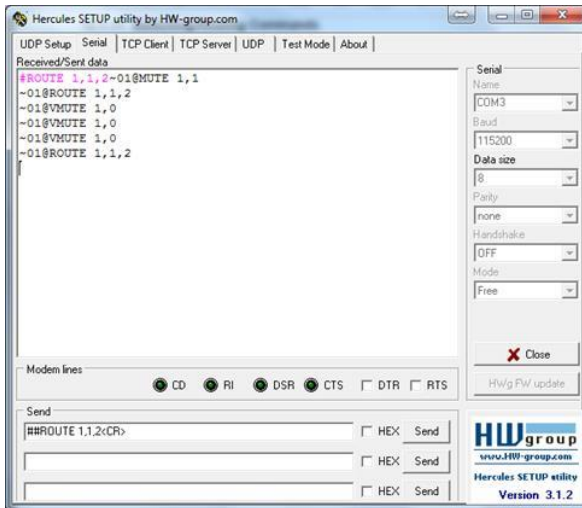

The framing of the command varies according to the terminal communication software.

- K-Touch Builder (Kramer software):

'Device Code (17)' PROPERTIES	
name	Device Code (17)
data	#ROUTE 1,1,2x0D

- K-Config (Kramer configuration software):

**Command Syntax**      Display Command as    Hex    Decimal    ASCII



All the examples provided in this section are based on using the K-Config software.

You can enter commands directly using terminal communication software (e.g., Hercules) by connecting a PC to the serial or Ethernet port on the **WP-20**. To enter  press the Enter key ( is also sent but is ignored by the command parser).

Commands sent from various non-Kramer controllers (e.g., Crestron) may require special coding for some characters (such as, /x##). For more information, refer to your controller's documentation.

For more information about:

- Using Protocol 3000 commands, see [Section 12.1](#)
- General syntax used for Protocol 3000 commands, see [Section 12.2](#)
- Protocol 3000 commands available for the **WP-20**, see [Section 12.3](#)

## 12.1 Understanding Protocol 3000

Protocol 3000 commands are structured according to the following:

- **Command** – A sequence of ASCII letters (A-Z, a-z and -). A command and its parameters must be separated by at least one space.
- **Parameters** – A sequence of alphanumeric ASCII characters (0-9, A-Z, a-z and some special characters for specific commands). Parameters are separated by commas.
- **Message string** – Every command entered as part of a message string begins with a message starting character and ends with a message closing character.



A string can contain more than one command. Commands are separated by a pipe (|) character.

The maximum string length is 64 characters.

- **Message starting character:**
  - # – For host command/query
  - ~ – For device response
- **Device address** – K-NET Device ID followed by @ (optional, K-NET only)
- **Query sign** – ? follows some commands to define a query request
- **Message closing character:**
  - CR – Carriage return for host messages (ASCII 13)
  - CR LF – Carriage return for device messages (ASCII 13) and line-feed (ASCII 10)
- **Command chain separator character** – Multiple commands can be chained in the same string. Each command is delimited by a pipe character (|). When chaining commands, enter the message starting character and the message closing character only at the beginning and end of the string.



Spaces between parameters or command terms are ignored. Commands in the string do not execute until the closing character is entered. A separate response is sent for every command in the chain.

## 12.2 Kramer Protocol 3000 Syntax

The Kramer Protocol 3000 syntax uses the following delimiters:

- **CR** = Carriage return (ASCII 13 = 0x0D)
- **LF** = Line feed (ASCII 10 = 0x0A)
- **SP** = Space (ASCII 32 = 0x20)

Some commands have short name syntax in addition to long name syntax to enable faster typing. The response is always in long syntax.

The Protocol 3000 syntax is in the following format:

- **Host Message Format:**

Start	Address (optional)	Body	Delimiter
#	<i>Device_id@</i>	<b>Message</b>	<b>CR</b>

- **Simple Command** – Command string with only one command without addressing:

Start	Body	Delimiter
#	<b>Command</b> <b>SP</b> <i>Parameter_1,Parameter_2,...</i>	<b>CR</b>

- **Command String** – Formal syntax with command concatenation and addressing:

Start	Address	Body	Delimiter
#	<i>Device_id@</i>	<b>Command_1</b> <i>Parameter1_1,Parameter1_2,...</i> <b>Command_2</b> <i>Parameter2_1,Parameter2_2,...</i> <b>Command_3</b> <i>Parameter3_1,Parameter3_2,...</i> ...	<b>CR</b>

- **Device Message Format:**

Start	Address (optional)	Body	Delimiter
~	<i>Device_id@</i>	<b>Message</b>	<b>CR</b> <b>LF</b>

- **Device Long Response** – Echoing command:

Start	Address (optional)	Body	Delimiter
~	<i>Device_id@</i>	<b>Command</b> <b>SP</b> [ <i>Param1,Param2 ...</i> ] <b>result</b>	<b>CR</b> <b>LF</b>

## 12.3 Protocol 3000 Commands

This section includes the following commands:

- System Commands (see [Section 12.3.1](#))
- Authentication Commands (see [Section 12.3.2](#))
- Switching/Routing Commands (see [Section 12.3.3](#))
- Video Commands (see [Section 12.3.4](#))
- Audio Commands (see [Section 12.3.5](#))
- Communication Commands (see [Section 12.3.6](#))
- EDID Handling Commands (see [Section 12.3.7](#))

### 12.3.1 System Commands

Command	Description
#	Protocol handshaking (system mandatory)
BUILD-DATE	Get device build date (system mandatory)
FACTORY	Reset to factory default configuration
HELP	Get command list (system mandatory)
MODEL	Get device model (system mandatory)
PROT-VER	Get device protocol version (system mandatory)
RESET	Reset device (system mandatory)
SN	Get device serial number (system mandatory)
VERSION	Get device firmware version (system mandatory)
AV-SW-MODE	Set/get auto switch mode (system)
AV-SW-TIMEOUT	Set/get auto switching timeout (system)
DISPLAY	Get output HPD status (system)
DPSW-STATUS	Get the DIP-switch status (system)
FPGA-VER	Get current FPGA version (system)
HDCP-MOD	Set/get HDCP mode (system)
HDCP-STAT	Get HDCP signal status (system)
NAME	Set/get machine (DNS) name (system – Ethernet)
NAME-RST	Reset machine (DNS) name to factory default (system – Ethernet)
PRIORITY	Set/get priority for all channels (system)
SIGNAL	Get input signal lock status (system)

### 12.3.1.1 #

Functions		Permission	Transparency
Set:	#	End User	Public
Get:	-	-	-
Description		Syntax	
Set:	Protocol handshaking	# <code>CR</code>	
Get:	-	-	
Response			
~ <code>nn@SPokCR LF</code>			
Parameters			
Response Triggers			
Notes			
Validates the Protocol 3000 connection and gets the machine number Step-in master products use this command to identify the availability of a device			
K-Config Example			
`#", 0x0D			

### 12.3.1.2 BUILD-DATE

Functions		Permission	Transparency
Set:	-	-	-
Get:	<b>BUILD-DATE?</b>	End User	Public
Description		Syntax	
Set:	-	-	
Get:	Get device build date	# <b>BUILD-DATE?</b> <code>CR</code>	
Response			
~ <code>nn@BUILD-DATESPdateSPtimeCR LF</code>			
Parameters			
<i>date</i> – Format: YYYY/MM/DD where YYYY = Year, MM = Month, DD = Day <i>time</i> – Format: hh:mm:ss where hh = hours, mm = minutes, ss = seconds			
Response Triggers			
Notes			
K-Config Example			
`#BUILD-DATE?", 0x0D			

### 12.3.1.3 FACTORY

Functions		Permission	Transparency
Set:	<b>FACTORY</b>	End User	Public
Get:	-	-	-
Description		Syntax	
Set:	Reset device to factory default configuration	# <b>FACTORY</b> <code>CR</code>	
Get:	-	-	
Response			
~ <code>hn</code> @ <b>FACTORY</b> <code>SP</code> <code>OK</code> <code>CR</code> <code>LF</code>			
Parameters			
Response Triggers			
Notes			
This command deletes all user data from the device. The deletion can take some time. Your device may require powering off and powering on for the changes to take effect.			
K-Config Example			
`#FACTORY`, 0x0D			

### 12.3.1.4 FEATURE-LIST

Functions		Permission	Transparency
Set:	-	-	-
Get:	<b>FEATURE-LIST?</b>	End User	Public
Description		Syntax	
Set:	-	-	
Get:	Get feature state according to the feature ID	# <b>FEATURE-LIST?</b> <code>SP</code> <code>id</code> <code>CR</code>	
Response			
~ <code>hn</code> @ <b>FEATURE-LIST</b> <code>SP</code> <code>id,enable</code> <code>CR</code> <code>LF</code>			
Parameters			
<i>id</i> – feature id number: 1 (Maestro), 2 (Room Controller), 3 (Maestro panel) <i>enable</i> – 0 (disable), 1 (enable)			
Response Triggers			
Notes			
K-Config Example			
Get feature state for Maestro: `#FEATURE-LIST? 1`, 0x0D			



### 12.3.1.5 HELP

Functions	Permission	Transparency
Set:	-	-
Get:	HELP	End User Public
Description	Syntax	
Set:	-	
Get:	Get command list or help for specific command	1. #HELP<CR> 2. #HELP<SP>COMMAND_NAME<CR>
Response		
1. Multi-line: ~<nn>@Device available protocol 3000 commands:<CR LF>command,<SP>command...<CR LF>		
2. Multi-line: ~<nn>@HELP<SP>command:<CR LF>description<CR LF>USAGE:usage<CR LF>		
Parameters		
COMMAND_NAME – name of a specific command		
Response Triggers		
Notes		
To get help for a specific command use: HELP<SP>COMMAND_NAME<CR LF>		
K-Config Example		
"#HELP", 0x0D		

### 12.3.1.6 MODEL

Functions	Permission	Transparency
Set:	-	-
Get:	MODEL?	End User Public
Description	Syntax	
Set:	-	
Get:	Get device model	#MODEL?<CR>
Response		
~<nn>@MODEL<SP>model_name<CR LF>		
Parameters		
model_name – String of up to 19 printable ASCII chars		
Response Triggers		
Notes		
This command identifies equipment connected to Step-in master products and notifies of identity changes to the connected equipment. The Matrix saves this data in memory to answer REMOTE-INFO requests		
K-Config Example		
"#MODEL?", 0x0D		

### 12.3.1.7 PROT-VER

Functions		Permission	Transparency
Set:	-	-	-
Get:	<b>PROT-VER?</b>	End User	Public
Description		Syntax	
Set:	-	-	
Get:	Get device protocol version	# <b>PROT-VER?</b> <code>CR</code>	
Response			
~nn@ <b>PROT-VER</b> <code>SE</code> 3000:version <code>CR LF</code>			
Parameters			
version - XX.XX where X is a decimal digit			
Response Triggers			
Notes			
K-Config Example			
"#PROT-VER?",0x0D			

### 12.3.1.8 RESET

Functions		Permission	Transparency
Set:	<b>RESET</b>	Administrator	Public
Get:	-	-	-
Description		Syntax	
Set:	Reset device	# <b>RESET</b> <code>CR</code>	
Get:	-	-	
Response			
~nn@ <b>RESET</b> <code>SE</code> OK <code>CR LF</code>			
Parameters			
Response Triggers			
Notes			
To avoid locking the port due to a USB bug in Windows, disconnect USB connections immediately after running this command. If the port was locked, disconnect and reconnect the cable to reopen the port.			
K-Config Example			
"#RESET",0x0D			

### 12.3.1.9 SN

Functions	Permission	Transparency
Set:	-	-
Get:	SN?	End User Public
Description	Syntax	
Set:	-	-
Get:	Get device serial number	#SN? <b>CR</b>
Response		
~nn@SN <b>SF</b> serial_number <b>CR LF</b>		
Parameters		
serial_number – 11 decimal digits, factory assigned		
Response Triggers		
Notes		
This device has a 14 digit serial number, only the last 11 digits are displayed		
K-Config Example		
"#SN?", 0x0D		

### 12.3.1.10 VERSION

Functions	Permission	Transparency
Set:	-	-
Get:	VERSION?	End User Public
Description	Syntax	
Set:	-	-
Get:	Get firmware version number	#VERSION? <b>CR</b>
Response		
~nn@VERSION <b>SF</b> firmware_version <b>CR LF</b>		
Parameters		
firmware_version – XX.XX.XXXX where the digit groups are: major.minor.build version		
Response Triggers		
Notes		
K-Config Example		
"#VERSION?", 0x0D		

### 12.3.1.11 AV-SW-MODE

Functions		Permission	Transparency
Set:			
Get:	AV-SW-MODE?	End user	Public
Description		Syntax	
Set:			
Get:	Get input auto switch mode (per output)	#AV-SW-MODE?SElayer,output_idCR	
Response			
~nn@AV-SW-MODESElayer,output_id,modeCR LF			
Parameters			
layer – 1 (video), 2 (audio) output_id – for video layer: 1 (HDBT Out), for audio layer: 1 (Audio Out) mode – 0 (manual), 1 (priority switch), 2 (last connected switch)			
Response Triggers			
Notes			
K-Config Example			
Get the input audio switch mode for HDBT Out: "#AV-SW-MODE? 1,1",0x0D			

### 12.3.1.12 AV-SW-TIMEOUT

Functions		Permission	Transparency
Set:	<b>AV-SW-TIMEOUT</b>	End User	Public
Get:	<b>AV-SW-TIMEOUT?</b>	End User	Public
Description		Syntax	
Set:	Set auto switching timeout	#AV-SW-TIMEOUT SP action,time_out CR	
Get:	Get auto switching timeout	#AV-SW-TIMEOUT? SP action CR	
Response			
~nn@AV-SW-TIMEOUT SP action,time_out CR			
Parameters			
<p><i>action</i> – event that triggers the auto switching timeout:</p> <ul style="list-style-type: none"> <li>0 (video signal lost)</li> <li>2 (audio signal lost)</li> <li>4 (disable 5V on video output if no input signal detected)</li> <li>5 (video cable unplugged)</li> <li>6 (audio cable unplugged)</li> </ul> <p><i>timeout</i> – timeout in seconds: 0-60000</p>			
Response Triggers			
Notes			
<p>The timeout must not exceed 60000 seconds.</p> <p>The timeout for video and audio signal lost (0, 2) events must not be less than 5 seconds.</p> <p>The timeout for video and audio cable unplugged (5, 6) events must not exceed the timeout for the disable 5V on video output if no input signal detected (4) event.</p> <p>The timeout for the disable 5V on video output if no input signal detected (4) event must not be less than the timeout for video and audio cable unplugged (5, 6) events.</p> <p>The timeout for the disable 5V on video output if no input signal detected (4) event overlaps with the timeouts for all other events (0, 2, 5, 6).</p>			
K-Config Example			
<p>Set the auto switching timeout to 5 seconds in the event of video signal lost:</p> <pre>"#AV-SW-TIMEOUT 0,5",0x0D</pre>			

### 12.3.1.13 DISPLAY

Functions		Permission	Transparency
Set:	-	-	-
Get	<b>DISPLAY?</b>	End User	Public
Description		Syntax	
Set:	-	-	
Get:	Get output HPD status	# <b>DISPLAY?</b> <code>[SE]</code> <code>out_id</code> <code>[CR]</code>	
Response			
~ <code>[nr]</code> <code>#DISPLAY?</code> <code>[SE]</code> <code>out_id,status</code> <code>[CR]</code> <code>[LF]</code>			
Parameters			
<i>out_id</i> - 1 (HDBT Out) <i>status</i> - HPD status according to signal validation : 0 (Off), 1 (On), 2 (On and all parameters are stable and valid)			
Response Triggers			
A response is sent to the com port from which the Get was received, after command execution and: After every change in output HPD status from On to Off (0) After every change in output HPD status from Off to On (1) After every change in output HPD status form Off to On and all parameters (new EDID, etc.) are stable and valid (2)			
Notes			
K-Config Example			
Get the output HPD status of HDBT Out: `#DISPLAY? 1",0x0D			

### 12.3.1.14 DPSW-STATUS

Functions	Permission	Transparency
Set:	-	-
Get	DPSW-STATUS?	End User Public
Description	Syntax	
Set:	-	-
Get:	Get the DIP-switch status	#DPSW-STATUS?SEdp_sw_idCR
Response		
~nn@DPSW-STATUS?SEdp_sw_id,statusCR LF		
Parameters		
<i>dp_sw_id</i> - 1 (video switch), 2 (video switch), 3 (audio switch), 4 (audio switch) <i>status</i> - 0 (up / Off), 1 (down / On)		
Response Triggers		
Notes		
K-Config Example		
Get the status of DIP-switch 1 (video switch): "#DPSW-STATUS? 1",0x0D		

### 12.3.1.15 FPGA-VER

Functions	Permission	Transparency
Set:	-	-
Get:	FPGA-VER?	End User Public
Description	Syntax	
Set:	-	-
Get:	Get current FPGA version	#FPGA-VER?SEidCR
Response		
~nn@FPGA-VERSEid,major_ver,minor_verCR LF		
Parameters		
<i>id</i> - 1 (FPGA) <i>major_ver</i> - Major FPGA version number for current firmware <i>minor_ver</i> - Minor FPGA version number for current firmware		
Response Triggers		
Notes		
FPGA - field programmable gate array		
K-Config Example		
Get the FPGA version number for the current firmware: "#FPGA-VER? 1",0x0D		

### 12.3.1.16 HDCP-MOD

Functions		Permission	Transparency
Set:	HDCP-MOD	Administrator	Public
Get:	HDCP-MOD?	End User	Public
Description		Syntax	
Set:	Set HDCP mode	#HDCP-MOD[SE]inp_id,mode[CR]	
Get:	Get HDCP mode	#HDCP-MOD?[SE]inp_id[CR]	
Response			
Set / Get: ~[nn]eHDCP-MOD[SE]inp_id,mode[CR LF]			
Parameters			
inp_id – input number: 1 (HDMI In 1), 2 (HDMI In 2), 3 (PC In) mode – HDCP mode: 0 (HDCP Off), 3 (Mirror output – MAC mode)			
Response Triggers			
A response is sent to the com port from which the set (before execution) / get command was received A response is sent to all com ports after command execution if HDCP-MOD was set by any other external control device (device button, device menu or other) or if the HDCP mode changed			
Notes			
Set HDCP working mode on the device input: HDCP not supported - HDCP Off HDCP support changes following detected sink - MIRROR OUTPUT			
K-Config Example			
Disable HDCP mode on HDMI In 2: `#HDCP-MOD 2,0",0x0D`			



### 12.3.1.17 HDCP-STAT

Functions		Permission	Transparency
Set:	-	-	-
Get:	<b>HDCP-STAT?</b>	End User	Public
Description		Syntax	
Set:	-	-	
Get:	Get HDCP signal status	# <b>HDCP-STAT?</b> <input type="checkbox"/> stage,stage_id <input type="checkbox"/>	
Response			
~ <input type="checkbox"/> @ <b>HDCP-STAT?</b> <input type="checkbox"/> stage,stage_id,mode <input type="checkbox"/> <input type="checkbox"/> <input type="checkbox"/>			
Parameters			
<i>stage</i> – 0 (input), 1 (output) <i>stage_id</i> – for input stage: 1 (HDMI In 1), 2 (HDMI In 2), 3 (PC In), for output stage: 1 (HDBT Out) <i>actual_status</i> – signal encryption status: 0 (On), 1 (Off)			
Response Triggers			
A response is sent to the com port from which the Get command was received			
Notes			
Output stage (1) – get the HDCP signal status of the sink device connected to HDBT Out Input stage (0) – get the HDCP signal status of the source device connected to the specified input			
K-Config Example			
Get the HDCP input signal status of the source device connected to HDMI In 1: "#HDCP-STAT? 0,1",0x0D			

### 12.3.1.18 NAME

Functions		Permission	Transparency
Set:	NAME	Administrator	Public
Get:	NAME?	End User	Public
Description		Syntax	
Set:	Set machine (DNS) name	#NAME[SP]machine_name[CR]	
Get:	Get machine (DNS) name	#NAME?[CR]	
Response			
Set:	~nn@NAME[SP]machine_name[CR LF]		
Get:	~nn@NAME?[SP]machine_name[CR LF]		
Parameters			
<i>machine_name</i> - String of up to 14 alpha-numeric characters (can include hyphens but not at the beginning or end)			
Response Triggers			
Notes			
The machine name is not the same as the model name. The machine name is used to identify a specific machine or a network in use (with DNS feature on).			
K-Config Example			
Set the DNS name of the device to "room-442": "#NAME room-442", 0x0D			

### 12.3.1.19 NAME-RST

Functions		Permission	Transparency
Set:	NAME-RST	Administrator	Public
Get:	-	-	-
Description		Syntax	
Set:	Reset machine (DNS) name to factory default	#NAME-RST[CR]	
Get:	-	-	
Response			
~nn@NAME-RST[SP]OK[CR LF]			
Parameters			
Response Triggers			
Notes			
Factory default of machine (DNS) name is "KRAMER_"			
K-Config Example			
Reset the DNS name of the device to the factory default: "#NAME-RST", 0x0D			

### 12.3.1.20 PRIORITY

Functions		Permission	Transparency
Set:	<b>PRIORITY</b>	Administrator	Public
Get:	<b>PRIORITY?</b>	Administrator	Public
Description		Syntax	
Set:	Set input priority	# <b>PRIORITY</b> <b>SE</b> layer, <i>PRIORITY1</i> , <i>PRIORITY2</i> , <i>PRIORITY3</i> <b>CR</b>	
Get:	Get input priority	# <b>PRIORITY?</b> layer <b>CR</b>	
Response			
~nn@ <b>PRIORITY</b> <b>SE</b> layer, <i>PRIORITY1</i> , <i>PRIORITY2</i> , <i>PRIORITY3</i> <b>CR LF</b>			
Parameters			
layer – 1 (video): <i>PRIORITY1</i> - priority of HDMI In 1: 1 (highest priority), 2 (second priority), 3 (third priority) <i>PRIORITY2</i> - priority of HDMI In 2: 1 (highest priority), 2 (second priority), 3 (third priority) <i>PRIORITY3</i> - priority of PC In: 1 (highest priority), 2 (second priority), 3 (third priority) layer – 2 (audio): <i>PRIORITY1</i> - priority of embedded audio: 1 (highest priority), 2 (second priority) <i>PRIORITY2</i> - priority of Audio In: 1 (highest priority), 2 (second priority)			
Response Triggers			
Notes			
The number of <b>PRIORITY</b> parameters differs according to the selected layer 1 is the highest priority			
K-Config Example			
Set the video input priority of PC In as the highest priority: "# <b>PRIORITY 1,2,3,1",0x0D</b>			

### 12.3.1.21 SIGNAL

Functions		Permission	Transparency
Set:	-	-	-
Get	<b>SIGNAL?</b>	End User	Public
Description		Syntax	
Set:	-	-	
Get:	Get input signal lock status	# <b>SIGNAL?</b> <code>S</code> <code>inp_id</code> <code>CR</code>	
Response			
~ <code>h</code> <code>SIGNAL</code> <code>S</code> <code>inp_id,status</code> <code>CR LF</code>			
Parameters			
<i>inp_id</i> – input number: 1 (HDMI In 1), 2 (HDMI In 2), 3 (PC In) <i>status</i> – lock status according to signal validation: 0 (Off), 1 (On)			
Response Triggers			
After execution, a response is sent to the com port from which the Get was received A response is sent after every change in input signal status from On to Off or from Off to On			
Notes			
K-Config Example			
Get the input signal lock status of HDMI In 2: `#SIGNAL? 2",0x0D`			

## 12.3.2 Authentication Commands

Command	Description
LOGIN	Set/get protocol permission
LOGOUT	Cancel current permission level
PASS	Set/get password for login level
SECUR	Set/get current security state

### 12.3.2.1 LOGIN

Functions	Permission	Transparency
Set: <b>LOGIN</b>	Not Secure	Public
Get: <b>LOGIN?</b>	Not Secure	Public
Description	Syntax	
Set: Set protocol permission	# <b>LOGIN</b> [ <b>SF</b> login_level,password] <b>CR</b>	
Get: Get current protocol permission level	# <b>LOGIN?</b> <b>CR</b>	
Response		
Set: ~ <b>nn</b> @ <b>LOGIN</b> [ <b>SF</b> login_level,password] <b>SF</b> OK <b>CR LF</b> or ~ <b>nn</b> @ <b>LOGIN</b> [ <b>SF</b> ERR <b>SF</b> 004] <b>CR LF</b> (if bad password entered)		
Get: ~ <b>nn</b> @ <b>LOGIN</b> [ <b>SF</b> login_level] <b>CR LF</b>		
Parameters		
<i>login_level</i> – level of permissions required: User, Admin <i>password</i> – predefined password (by <b>PASS</b> command). Default password is an empty string		
Response Triggers		
Notes		
When the permission system is enabled, <b>LOGIN</b> enables running commands with the User or Administrator permission level When set, login must be performed upon each connection The permission system works only if security is enabled with the <b>SECUR</b> command. It is not mandatory to enable the permission system in order to use the device		
K-Config Example		
Set the protocol permission level to Admin (when the password defined in the <b>PASS</b> command is 33333): "#LOGIN Admin,33333",0x0D		

### 12.3.2.2 LOGOUT

Functions		Permission	Transparency
Set:	<b>LOGOUT</b>	Not Secure	Public
Get:	-	-	-
Description		Syntax	
Set:	Cancel current permission level	# <b>LOGOUT</b> <code>[CR]</code>	
Get:	-	-	
Response			
~ <code>[nn]</code> @ <b>LOGOUT</b> <code>[SP]ok</code> <code>[CR LF]</code>			
Parameters			
Response Triggers			
Notes			
Logs out from User or Administrator permission levels			
K-Config Example			
"#LOGOUT",0x0D			

### 12.3.2.3 PASS

Functions		Permission	Transparency
Set:	<b>PASS</b>	Administrator	Public
Get:	<b>PASS?</b>	Administrator	Public
Description		Syntax	
Set:	Set password for login level	# <b>PASS</b> <code>[SE]login_level,password</code> <code>[CR]</code>	
Get:	Get password for login level	# <b>PASS?</b> <code>[SE]login_level</code> <code>[CR]</code>	
Response			
~ <code>[nn]</code> @ <b>PASS</b> <code>[SE]login_level,password</code> <code>[CR LF]</code>			
Parameters			
<i>login_level</i> – level of login to set: User, Admin <i>password</i> – password for the <i>login_level</i> . Up to 15 printable ASCII chars.			
Response Triggers			
Notes			
The default password is an empty string			
K-Config Example			
Set the password for the Admin protocol permission level to 33333: "#PASS Admin,33333",0x0D			

### 12.3.2.4 SECUR

Functions		Permission	Transparency
Set:	<b>SECUR</b>	Administrator	Public
Get:	<b>SECUR?</b>	Not Secure	Public
Description		Syntax	
Set:	Start/stop security	#SECUR <sup>SE</sup> security_mode <sup>CR</sup>	
Get:	Get current security state	#SECUR? <sup>CR</sup>	
Response			
~nn <sup>e</sup> #SECUR <sup>SE</sup> security_mode <sup>CR LF</sup>			
Parameters			
security_mode - 1 (On / enable security), 0 (Off / disable security)			
Response Triggers			
Notes			
The permission system works only if security is enabled with the SECUR command			
K-Config Example			
Enable the permission system: "#SECUR 0",0x0D			

### 12.3.3 Switching/Routing Commands

Command	Description
ROUTE	Set/get layer routing

#### 12.3.3.1 ROUTE

Functions		Permission	Transparency
Set:	ROUTE	End User	Public
Get:	ROUTE?	End User	Public
Description		Syntax	
Set:	Set layer routing	#ROUTE <u>SF</u> layer, dest, src <u>CR</u>	
Get:	Get layer routing	#ROUTE? <u>SF</u> layer, dest <u>CR</u>	
Response			
~nn@ROUTE <u>SF</u> layer, dest, src <u>CR</u> LF			
Parameters			
layer – 1 (video), 3 (data) dest – for video layer: 1 (HDBT Out), for data layer: 1 (HDBT data port), 2 ( <b>WP-20</b> data port), 3 ( <b>WP-20</b> internal control port) src – for video layer: 1 (HDMI In 1), 2 (PC In), for data layer: 1 (HDBT data port), 2 ( <b>WP-20</b> data port), 3 ( <b>WP-20</b> internal control port)			
Response Triggers			
Notes			
The get command identifies input switching on Step-in clients The set command is for remote input switching on Step-in clients (essentially via by the Web)			
K-Config Example			
Set the remote input switching of data to control mode: `#ROUTE 3,1,3",0x0D Set the remote input switching of data to data mode: `#ROUTE 3,1,2",0x0D			



## 12.3.4 Video Commands

Command	Description
VGA-PHASE	Set/get ADC (VGA) sampling phase
VMUTE	Set/get video on output mute

### 12.3.4.1 VGA-PHASE

Functions		Permission	Transparency
Set:	VGA-PHASE	End User	Public
Get:	VGA-PHASE?	End User	Public
Description		Syntax	
Set:	Set ADC (VGA) sampling phase	#VGA-PHASE <sup>SF</sup> <i>channel</i> , <i>value</i> <sup>CR</sup>	
Get:	Get ADC (VGA) sampling phase	#VGA-PHASE? <sup>SF</sup> <i>channel</i> <sup>CR</sup>	
Response			
~ <sup>nn</sup> @VGA-PHASE <sup>SF</sup> <i>channel</i> , <i>value</i> <sup>CR LF</sup>			
Parameters			
<i>channel</i> – input number: 3 (PC In)			
<i>value</i> – phase number in LSB units: 1-30, ++ (increase current value), -- (decrease current value)			
Response Triggers			
Notes			
K-Config Example			
Increase the current value of the ADC (VGA) sampling phase: "#VGA-PHASE 3,++,0x0D			

### 12.3.4.2 VMUTE

Functions		Permission	Transparency
Set:	<b>VMUTE</b>	End User	Public
Get:	<b>VMUTE?</b>	End User	Public
Description		Syntax	
Set:	Set enable/disable video on output	# <b>VMUTE</b> [ <b>SE</b> ]output_id,flag[ <b>CR</b> ]	
Get:	Get video on output status	# <b>VMUTE?</b> [ <b>SE</b> ]output_id[ <b>SE</b> ] [ <b>CR</b> ]	
Response			
Set / Get: ~[ <b>nn</b> ]@ <b>VMUTE</b> [ <b>SE</b> ]output_id,flag[ <b>CR</b> ] LF			
Parameters			
output_id - 1 (HDBT Out) flag - 0 (disable video on output), 1 (enable video on output), 2 (blank video)			
Response Triggers			
Notes			
K-Config Example			
Disable the video output on HDBT Out: "#VMUTE 3,0",0x0D			

### 12.3.5 Audio Commands

Command	Description
AUD-EMB	Get audio in video embedding status
AUD-LVL	Set/get volume for specific amplifier output
AUD-SIGNAL?	Get audio input signal status
MUTE	Set/get audio mute

#### 12.3.5.1 AUD-EMB

Functions	Permission	Transparency
Set:		
Get:	AUD-EMB?	End User Public
Description	Syntax	
Set:		
Get:	Get audio in video embedding status	#AUD-EMB? <u>SF</u> <i>in,out</i> <u>CR</u>
Response		
~nn@AUD-EMB <u>SF</u> <i>in,out,status</i> <u>CR LF</u>		
Parameters		
<i>in</i> – embedded audio input number: 1 (Audio In) <i>out</i> – video output number in which audio is embedded: 1 (HDBT Out) <i>status</i> – embedded status: 1 (On), 0 (Off)		
Response Triggers		
A response is sent to the com port from which the get command was received After execution, a response is sent to all com ports if AUD-EMB was set by any other external control device (button press, device menu and similar)		
Notes		
K-Config Example		
"#AUD-EMB? 1,1",0x0D		

### 12.3.5.2 AUD-LVL

Functions		Permission	Transparency
Set:	<b>AUD-LVL</b>	End User	Public
Get:	<b>AUD-LVL?</b>	End User	Public
Description		Syntax	
Set:	Set volume for specific amplifier output	# <b>AUD-LVL</b> <input type="checkbox"/> <i>stage,channel,volume</i> <input type="checkbox"/>	
Get:	Get volume for specific amplifier output	# <b>AUD-LVL?</b> <input type="checkbox"/> <i>stage,channel</i> <input type="checkbox"/>	
Response			
~ <input type="checkbox"/> @ <b>AUD-LVL</b> <input type="checkbox"/> <i>stage,channel,volume</i> <input type="checkbox"/> LF			
Parameters			
<i>stage</i> – 1 (audio output) <i>channel</i> – output channel number of selected stage: 1 (Audio Out) <i>volume</i> – audio volume: -83+24 (dB value), ++ (increase current value by 0.5dB), -- (decrease current value by 0.5dB)			
Response Triggers			
Notes			
All values are in decibels (dB) A minus sign precedes negative values			
K-Config Example			
Set the volume of the Audio Out (1) output to -17dB: "#AUD-LVL 1,1,-17",0x0D			

### 12.3.5.1 AUD-LVL-RANGE

Functions		Permission	Transparency
Set:	<b>AUD-LVL-RANGE</b>	End User	Public
Get:	<b>AUD-LVL-RANGE?</b>	End User	Public
Description		Syntax	
Set:	Set audio level min and max range	# <b>AUD-LVL-RANGE</b> <b>SP</b>	<i>stage,channel,min_val,max_val</i> <b>CR</b>
Get:	Get audio level min and max range	# <b>AUD-LVL-RANGE?</b> <b>SP</b>	<i>stage,channel</i> <b>CR</b>
Response			
~ <b>nn</b> @ <b>AUD-LVL-RANGE</b> <b>SP</b> <i>stage,channel,min_val,max_val</i> <b>CR LF</b>			
Parameters			
<i>stage</i> – 1 (audio output)			
<i>channel</i> – output channel number of selected stage: 1 (Audio Out)			
<i>min_val</i> – minimum available audio level: range = -83 to +24			
<i>max_val</i> – maximum available audio level: range = -83 to +24			
Response Triggers			
Notes			
All values are in decibels (dB)			
A minus sign precedes negative values			
K-Config Example			
Set the audio level to a minimum of -17Db and a maximum of +15Db: "#AUD-LVL-RANGE 1,1,-17,15",0x0D			

### 12.3.5.2 AUD-ONLY

Functions		Permission	Transparency
Set:	<b>AUD-ONLY</b>	End User	Public
Get:	<b>AUD-ONLY?</b>	End User	Public
Description		Syntax	
Set:	Enable/Disable audio only mode	# <b>AUD-ONLY</b> <b>SP</b>	<i>channel,mode</i> <b>CR</b>
Get:	Get audio only mode status	# <b>AUD-ONLY?</b> <b>CR</b>	
Response			
~ <b>nn</b> @ <b>AUD-ONLY</b> <b>SP</b> <i>channel,mode</i> <b>CR LF</b>			
Parameters			
<i>channel</i> – output channel number of selected stage: 1 (Audio Out)			
<i>mode</i> – audio only status: 0 (disabled), 1 (enabled)			
Response Triggers			
Notes			
K-Config Example			
Enable audio only mode: "#AUD-ONLY 1,1,0x0D			

### 12.3.5.3 AUD-SIGNAL

Functions		Permission	Transparency
Set:	-	-	-
Get	<b>AUD-SIGNAL?</b>	End User	Public
Description		Syntax	
Set:	-	-	
Get:	Get audio input signal status	# <b>AUD-SIGNAL?</b> <code>[SP]</code> <i>inp_id</i> <code>[CR]</code>	
Response			
~ <code>[nn]</code> @ <b>AUD-SIGNAL</b> <code>[SP]</code> <i>inp_id,status</i> <code>[CR LF]</code>			
Parameters			
<i>inp_id</i> – audio input number: 1 (Audio In) <i>status</i> – 0 (Off / no signal), 1 (On / signal present)			
Response Triggers			
After execution, a response is sent to the com port from which the get command was received A response is sent to all com ports if the audio status was changed on any input			
Notes			
K-Config Example			
"#AUD-SIGNAL? 1",0x0D			

### 12.3.5.4 MUTE

Functions		Permission	Transparency
Set:	<b>MUTE</b>	End User	Public
Get:	<b>MUTE?</b>	End User	Public
Description		Syntax	
Set:	Set audio mute	# <b>MUTE</b> <code>[SP]</code> <i>channel,mute_mode</i> <code>[CR]</code>	
Get:	Get audio mute	# <b>MUTE?</b> <code>[SP]</code> <i>channel</i> <code>[CR]</code>	
Response			
~ <code>[nn]</code> @ <b>MUTE</b> <code>[SP]</code> <i>channel, mute_mode</i> <code>[CR LF]</code>			
Parameters			
<i>channel</i> – audio output number: 1 (Audio Out) <i>mute_mode</i> – 0 (Off), 1 (On)			
Response Triggers			
Notes			
K-Config Example			
Mute the Audio Out output: "#MUTE 1,1",0x0D			

## 12.3.6 Communication Commands

Command	Description
ETH-PORT	Set/get Ethernet port protocol
NET-DHCP	Set/get DHCP mode
NET-GATE	Set/get gateway IP
NET-IP	Set/get IP address
NET-MAC	Get MAC address
NET-MASK	Set/get subnet mask

### 12.3.6.1 ETH-PORT

Functions		Permission	Transparency
Set:	<b>ETH-PORT</b>	Administrator	Public
Get:	<b>ETH-PORT?</b>	End User	Public
Description		Syntax	
Set:	Set Ethernet port protocol	# <b>ETH-PORT</b> <b>[SE]</b> <i>portType</i> , <i>ETHPort</i> <b>[CR]</b>	
Get:	Get Ethernet port protocol	# <b>ETH-PORT?</b> <b>[SE]</b> <i>portType</i> <b>[CR]</b>	
Response			
~nn@ <b>ETH-PORT</b> <b>[SE]</b> <i>portType</i> , <i>ETHPort</i> <b>[CR LE]</b>			
Parameters			
<i>portType</i> – string of 3 letters indicating the port type: TCP, UDP			
<i>ETHPort</i> – TCP / UDP port number: 0-65565			
Response Triggers			
Notes			
If the port number you enter is already in use, an error is returned The port number must be within the following range: 0-(2^16-1)			
K-Config Example			
Set the Ethernet port protocol for TCP to port 12457: "#ETH-PORT TCP,12457",0x0D			

### 12.3.6.2 NET-DHCP

Functions		Permission	Transparency
Set:	NET-DHCP	Administrator	Public
Get:	NET-DHCP?	End User	Public
Description		Syntax	
Set:	Set DHCP mode	#NET-DHCP <input type="checkbox"/> mode <input type="checkbox"/>	
Get:	Get DHCP mode	#NET-DHCP? <input type="checkbox"/>	
Response			
~nn@NET-DHCP <input type="checkbox"/> mode <input type="checkbox"/> CR LF			
Parameters			
mode – 0 (do not use DHCP. Use the IP address set by the factory or the NET-IP command), 1 (try to use DHCP. If unavailable, use the IP address set by the factory or the NET-IP command)			
Response Triggers			
Notes			
<p>Connecting Ethernet to devices with DHCP may take more time in some networks</p> <p>To connect with a randomly assigned IP by DHCP, specify the device DNS name (if available) using the NAME command. You can also get an assigned IP by direct connection to USB or RS-232 protocol port if available</p> <p>Consult your network administrator for correct settings</p>			
K-Config Example			
<p>Enable DHCP mode, if available:</p> <pre>"#NET-DHCP 1",0x0D</pre>			



### 12.3.6.3 NET-GATE

Functions		Permission	Transparency
Set:	<b>NET-GATE</b>	Administrator	Public
Get:	<b>NET-GATE?</b>	End User	Public
Description		Syntax	
Set:	Set gateway IP	# <b>NET-GATE</b> <b>[SP]</b> <i>ip_address</i> <b>[CR]</b>	
Get:	Get gateway IP	# <b>NET-GATE?</b> <b>[CR]</b>	
Response			
~nn@ <b>NET-GATE</b> <b>[SP]</b> <i>ip_address</i> <b>[CR LF]</b>			
Parameters			
<i>ip_address</i> – gateway IP address, in the following format: xxx.xxx.xxx.xxx			
Response Triggers			
Notes			
A network gateway connects the device via another network, possibly over the Internet. Be careful of security problems. Consult your network administrator for correct settings.			
K-Config Example			
Set the gateway IP address to 192.168.0.1: "#NET-GATE 192.168.000.001",0x0D			

### 12.3.6.4 NET-IP

Functions		Permission	Transparency
Set:	<b>NET-IP</b>	Administrator	Public
Get:	<b>NET-IP?</b>	End User	Public
Description		Syntax	
Set:	Set IP address	# <b>NET-IP</b> <b>[SP]</b> <i>ip_address</i> <b>[CR]</b>	
Get:	Get IP address	# <b>NET-IP?</b> <b>[CR]</b>	
Response			
~nn@ <b>NET-IP</b> <b>[SP]</b> <i>ip_address</i> <b>[CR LF]</b>			
Parameters			
<i>ip_address</i> – IP address, in the following format: xxx.xxx.xxx.xxx			
Response Triggers			
Notes			
Consult your network administrator for correct settings			
K-Config Example			
Set the IP address to 192.168.1.39: "#NET-IP 192.168.001.039",0x0D			

### 12.3.6.5 NET-MAC

Functions		Permission	Transparency
Set:	-	-	-
Get:	NET-MAC?	End User	Public
Description		Syntax	
Set:	-	-	
Get:	Get MAC address	#NET-MAC?CR	
Response			
~nn@NET-MACSEmac_addressCR LF			
Parameters			
mac_address – unique MAC address. Format: XX-XX-XX-XX-XX-XX where X is hex digit			
Response Triggers			
Notes			
K-Config Example			
"#NET-MAC?",0x0D			

### 12.3.6.6 NET-MASK

Functions		Permission	Transparency
Set:	NET-MASK	Administrator	Public
Get:	NET-MASK?	End User	Public
Description		Syntax	
Set:	Set subnet mask	#NET-MASKSEnet_maskCR	
Get:	Get subnet mask	#NET-MASK?CR	
Response			
~nn@NET-MASKSEnet_maskCR LF			
Parameters			
net_mask - format: xxx.xxx.xxx.xxx			
Response Triggers			
The subnet mask limits the Ethernet connection within the local network Consult your network administrator for correct settings			
Notes			
K-Config Example			
Set the subnet mask to 255.255.0.0: "#NET-MASK 255.255.000.000",0x0D			

## 12.3.7 EDID Handling Commands

Additional EDID data functions can be performed via the **WP-20** web pages or a compatible EDID management application, such as Kramer EDID Designer (see [www.kramerav.com/product/EDID%20Designer](http://www.kramerav.com/product/EDID%20Designer)).

Command	Description
CPEDID	Copy EDID data from the output to the input EEPROM
LOCK-EDID	Lock last read EDID

### 12.3.7.1 CPEDID

Functions	Permission	Transparency
Set: <b>CPEDID</b>	End User	Public
Get: -	-	-
Description	Syntax	
Set: Copy EDID data from the output to the input EEPROM	# <b>CPEDID</b> [ <b>SF</b> src_type,src_id,dst_type,dest_bitmap] <b>CR</b>	
Get: -	-	
Response		
~[nn]@ <b>CPEDID</b> [ <b>SF</b> src_type,src_id,dst_type,dest_bitmap] <b>CR LF</b>		
Parameters		
<p>src_type – EDID source type (usually output): 0 (input), 1 (output), 2 (default EDID)</p> <p>src_id – for input source: 1 (HDMI In 1), 2 (HDMI In 2), 3 (PC In), for output source: 1 (HDBT Out), for default EDID source: 0 (default EDID)</p> <p>dst_type – EDID destination type (usually input): 0 (input), 1 (output), 2 (default EDID)</p> <p>dest_bitmap – bitmap representing destination IDs. Format: XXXX...X, where X is hex digit. The binary form of every hex digit represents corresponding destinations. Setting '1' indicates that EDID data is copied to this destination. Setting '0' indicates that EDID data is not copied to this destination.</p>		
Response Triggers		
Response is sent to the com port from which the Set was received (before execution)		
Notes		
<p>Destination bitmap size depends on device properties (for 64 inputs it is a 64-bit word)</p> <p>Example: bitmap 0x0013 means inputs 1, 2 and 5 are loaded with the new EDID.</p> <p>In this device, if the destination type is input (0), the bitmap size is 3 bits, for example bitmap 0x5 means inputs 1 and 3 are loaded with the new EDID.</p>		
K-Config Example		
<p>Copy the EDID data from the HDBT Out output (EDID source) to the HDMI In 1 input:</p> <pre>"#CPEDID 1,1,0,0x1",0x0D</pre> <p>Copy the EDID data from the default EDID source to HDMI In 1 and PC In inputs:</p> <pre>"#CPEDID 2,0,0,0x5",0x0D</pre>		

### 12.3.7.2 LOCK-EDID

Functions		Permission	Transparency
Set:	LOCK-EDID	End User	End User
Get:	LOCK-EDID?	End User	End User
Description		Syntax	
Set:	Lock last read EDID	#LOCK-EDID <input type="checkbox"/> <i>input_id</i> , <i>lock_mode</i> <input type="checkbox"/>	
Get :	Get EDID lock state	#LOCK-EDID? <input type="checkbox"/> <i>input_id</i> <input type="checkbox"/>	
Response			
~nn@LOCK-EDID <input type="checkbox"/> <i>input_id</i> , <i>lock_mode</i> <input type="checkbox"/> LF			
Parameters			
<i>input_id</i> - 1 (HDMI In 1), 2 (HDMI In 2), 3 (PC In), <i>lock_mode</i> - 0 (Off: unlocks EDID), 1 (On: locks EDID)			
Response Triggers			
Notes			
K-Config Example			
Lock the last read EDID from the HDMI In 2 input: "#LOCK-EDID 2,1",0x0D			

## LIMITED WARRANTY

The warranty obligations of Kramer Electronics for this product are limited to the terms set forth below:

### What is Covered

This limited warranty covers defects in materials and workmanship in this product.

### What is Not Covered

This limited warranty does not cover any damage, deterioration or malfunction resulting from any alteration, modification, improper or unreasonable use or maintenance, misuse, abuse, accident, neglect, exposure to excess moisture, fire, improper packing and shipping (such claims must be presented to the carrier), lightning, power surges, or other acts of nature. This limited warranty does not cover any damage, deterioration or malfunction resulting from the installation or removal of this product from any installation, any unauthorized tampering with this product, any repairs attended by anyone unauthorized by Kramer Electronics to make such repairs, or any other cause which does not relate directly to a defect in materials and/or workmanship of this product. This limited warranty does not cover cartons, equipment enclosures, cables or accessories used in conjunction with this product.

Without limiting any other exclusion herein, Kramer Electronics does not warrant that the product covered hereby, including, without limitation, the technology and/or integrated circuit(s) included in the product, will not become obsolete or that such items are or will remain compatible with any other product or technology with which the product may be used.

### How Long Does this Coverage Last

Seven years as of this printing; please check our Web site for the most current and accurate warranty information.

### Who is Covered

Only the original purchaser of this product is covered under this limited warranty. This limited warranty is not transferable to subsequent purchasers or owners of this product.

### What Kramer Electronics will do

Kramer Electronics will, at its sole option, provide one of the following three remedies to whatever extent it shall deem necessary to satisfy a proper claim under this limited warranty:

1. Elect to repair or facilitate the repair of any defective parts within a reasonable period of time, free of any charge for the necessary parts and labor to complete the repair and restore this product to its proper operating condition. Kramer Electronics will also pay the shipping costs necessary to return this product once the repair is complete.
2. Replace this product with a direct replacement or with a similar product deemed by Kramer Electronics to perform substantially the same function as the original product.
3. Issue a refund of the original purchase price less depreciation to be determined based on the age of the product at the time remedy is sought under this limited warranty.

### What Kramer Electronics will not do Under This Limited Warranty

If this product is returned to Kramer Electronics or the authorized dealer from which it was purchased or any other party authorized to repair Kramer Electronics products, this product must be insured during shipment, with the insurance and shipping charges prepaid by you. If this product is returned uninsured, you assume all risks of loss or damage during shipment. Kramer Electronics will not be responsible for any costs related to the removal or re-installation of this product from or into any installation. Kramer Electronics will not be responsible for any costs related to any setting up this product, any adjustment of user controls or any programming required for a specific installation of this product.

### How to Obtain a Remedy under this Limited Warranty

To obtain a remedy under this limited warranty, you must contact either the authorized Kramer Electronics reseller from whom you purchased this product or the Kramer Electronics office nearest you. For a list of authorized Kramer Electronics resellers and/or Kramer Electronics authorized service providers, please visit our web site at [www.kramerelectronics.com](http://www.kramerelectronics.com) or contact the Kramer Electronics office nearest you.

In order to pursue any remedy under this limited warranty, you must possess an original, dated receipt as proof of purchase from an authorized Kramer Electronics reseller. If this product is returned under this limited warranty, a return authorization number, obtained from Kramer Electronics, will be required. You may also be directed to an authorized reseller or a person authorized by Kramer Electronics to repair the product.

If it is decided that this product should be returned directly to Kramer Electronics, this product should be properly packed, preferably in the original carton, for shipping. Cartons not bearing a return authorization number will be refused.

### Limitation on Liability

THE MAXIMUM LIABILITY OF KRAMER ELECTRONICS UNDER THIS LIMITED WARRANTY SHALL NOT EXCEED THE ACTUAL PURCHASE PRICE PAID FOR THE PRODUCT. TO THE MAXIMUM EXTENT PERMITTED BY LAW, KRAMER ELECTRONICS IS NOT RESPONSIBLE FOR DIRECT, SPECIAL, INCIDENTAL OR CONSEQUENTIAL DAMAGES RESULTING FROM ANY BREACH OF WARRANTY OR CONDITION, OR UNDER ANY OTHER LEGAL THEORY. Some countries, districts or states do not allow the exclusion or limitation of relief, special, incidental, consequential or indirect damages, or the limitation of liability to specified amounts, so the above limitations or exclusions may not apply to you.

### Exclusive Remedy

TO THE MAXIMUM EXTENT PERMITTED BY LAW, THIS LIMITED WARRANTY AND THE REMEDIES SET FORTH ABOVE ARE EXCLUSIVE AND IN LIEU OF ALL OTHER WARRANTIES, REMEDIES AND CONDITIONS, WHETHER ORAL OR WRITTEN, EXPRESS OR IMPLIED. TO THE MAXIMUM EXTENT PERMITTED BY LAW, KRAMER ELECTRONICS SPECIFICALLY DISCLAIMS ANY AND ALL IMPLIED WARRANTIES, INCLUDING WITHOUT LIMITATION, WARRANTIES OF MERCHANTABILITY AND FITNESS FOR A PARTICULAR PURPOSE. IF KRAMER ELECTRONICS CANNOT LAWFULLY DISCLAIM OR EXCLUDE IMPLIED WARRANTIES UNDER APPLICABLE LAW, THEN ALL IMPLIED WARRANTIES COVERING THIS PRODUCT, INCLUDING WARRANTIES OF MERCHANTABILITY AND FITNESS FOR A PARTICULAR PURPOSE, SHALL APPLY TO THIS PRODUCT AS PROVIDED UNDER APPLICABLE LAW.

IF ANY PRODUCT TO WHICH THIS LIMITED WARRANTY APPLIES IS A "CONSUMER PRODUCT" UNDER THE MAGNUSON-MOSS WARRANTY ACT (15 U.S.C.A. §2301, ET SEQ.) OR OTHER APPLICABLE LAW, THE FOREGOING DISCLAIMER OF IMPLIED WARRANTIES SHALL NOT APPLY TO YOU, AND ALL IMPLIED WARRANTIES ON THIS PRODUCT, INCLUDING WARRANTIES OF MERCHANTABILITY AND FITNESS FOR THE PARTICULAR PURPOSE, SHALL APPLY AS PROVIDED UNDER APPLICABLE LAW.

### Other Conditions

This limited warranty gives you specific legal rights, and you may have other rights which vary from country to country or state to state.

This limited warranty is void if (i) the label bearing the serial number of this product has been removed or defaced, (ii) the product is not distributed by Kramer Electronics or (iii) this product is not purchased from an authorized Kramer Electronics reseller. If you are unsure whether a reseller is an authorized Kramer Electronics reseller, please visit our Web site at [www.kramerelectronics.com](http://www.kramerelectronics.com) or contact a Kramer Electronics office from the list at the end of this document.

Your rights under this limited warranty are not diminished if you do not complete and return the product registration form or complete and submit the online product registration form. Kramer Electronics thanks you for purchasing a Kramer Electronics product. We hope it will give you years of satisfaction.

# KRAMER



P/N: 2900-300386



Rev: 5



## SAFETY WARNING

Disconnect the unit from the power supply before opening and servicing

For the latest information on our products and a list of Kramer distributors, visit our Web site to find updates to this user manual.

We welcome your questions, comments, and feedback.

[www.KramerAV.com](http://www.KramerAV.com)  
[info@KramerAV.com](mailto:info@KramerAV.com)