

**Kramer Electronics, Ltd.**

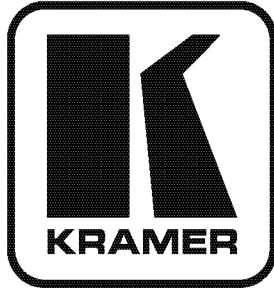

# **USER MANUAL**

**Model:**

**VS-211HDx1**

*3G HD-SDI Automatic Standby Switcher*

## Contents

<b>1</b>	<b>Introduction</b>	<b>1</b>
<b>2</b>	<b>Getting Started</b>	<b>1</b>
2.1	Quick Start	2
<b>3</b>	<b>Overview</b>	<b>3</b>
<b>4</b>	<b>Your VS-211HDx1 3G HD-SDI Automatic Standby Switcher</b>	<b>4</b>
<b>5</b>	<b>Using the VS-211HDx1</b>	<b>5</b>
5.1	Connecting the VS-211HDx1 3G HD-SDI Automatic Standby Switcher	5
5.2	Selecting the Default Master Source Signal	6
5.3	Connecting the REMOTE Terminal Block Connector	7
<b>6</b>	<b>Technical Specifications</b>	<b>8</b>

## Figures

Figure 1:	VS-211HDx1 3G HD-SDI Automatic Standby Switcher	4
Figure 2:	VS-211HDx1 3G HD-SDI Automatic Standby Switcher Connections	6
Figure 3:	REMOTE Terminal Block Connector	7

## Tables

Table 1:	VS-211HDx1 3G HD-SDI Automatic Standby Switcher Features	4
Table 2:	Technical Specifications of the VS-211HDx1	8

## 1 Introduction

Welcome to Kramer Electronics! Since 1981, Kramer Electronics has been providing a world of unique, creative, and affordable solutions to the vast range of problems that confront the video, audio, presentation, and broadcasting professional on a daily basis. In recent years, we have redesigned and upgraded most of our line, making the best even better! Our 1,000-plus different models now appear in 11 groups<sup>1</sup> that are clearly defined by function.

Congratulations on purchasing your Kramer DigiTOOLS® **VS-211HDx1** *3G HD-SDI Automatic Standby Switcher*. This product is ideal for providing backup switching for broadcast and post-production applications.

The package includes the following items:

- **VS-211HDx1** *3G HD-SDI Automatic Standby Switcher*
- Power adapter (5V DC Input)
- This user manual<sup>2</sup>

## 2 Getting Started

We recommend that you:

- Unpack the equipment carefully and save the original box and packaging materials for possible future shipment
- Review the contents of this user manual
- Use Kramer high-performance high-resolution cables<sup>3</sup>

---

1 GROUP 1: Distribution Amplifiers; GROUP 2: Switchers and Matrix Switchers; GROUP 3: Control Systems; GROUP 4: Format/Standards Converters; GROUP 5: Range Extenders and Repeaters; GROUP 6: Specialty AV Products; GROUP 7: Scan Converters and Sealers; GROUP 8: Cables and Connectors; GROUP 9: Room Connectivity; GROUP 10: Accessories and Rack Adapters; GROUP 11: Sierra Products

2 Download up-to-date Kramer user manuals from our Web site at <http://www.kramerelectronics.com>

3 The complete list of Kramer cables is on our Web site at <http://www.kramerelectronics.com>

## 2.1 Quick Start

This quick start chart summarizes the basic setup and operation steps.

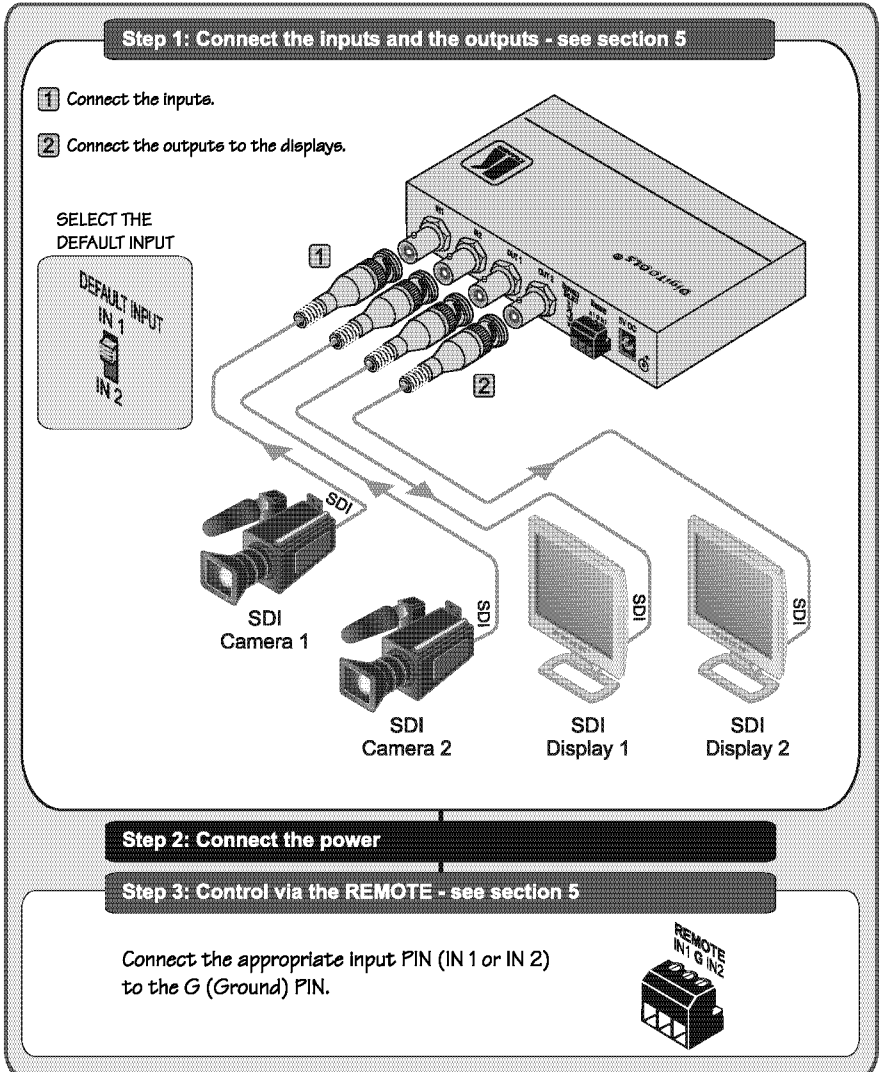

### 3 Overview

The **VS-211HDx1** is a high-performance automatic standby switcher for SD/HD-SDI and 3G HD-SDI video signals. The **VS-211HDx1** automatically switches to the secondary input whenever the primary video signal is interrupted. If the primary signal reappears, the unit automatically switches back to the primary input.

In addition, the **VS-211HDx1** features:

- Maximum data rate of up to 2.97Gbps
- Multi-standard operation – SMPTE 259M, 292M and 424M compliance and support for data rates of 270Mbps, 1483.5Mbps, 1485Mbps and 2970Mbps
- A DEFAULT INPUT switch for selecting the default SDI master source signal
- Contact closure remote control for forced operation
- Active switching and has flexible sync detection and reconstruction circuitry

To achieve the best performance:

- Use only good quality connection cables<sup>1</sup> to avoid interference, deterioration in signal quality due to poor matching, and elevated noise levels (often associated with low quality cables)
- Avoid interference from neighboring electrical appliances that may adversely influence signal quality and position your Kramer **VS-211HDx1** away from moisture, excessive sunlight and dust

	<b>Caution:</b> No operator serviceable parts inside unit
	<b>Warning:</b> Use only the Kramer Electronics input power wall adapter that is provided with the unit
	<b>Warning:</b> Disconnect power and unplug unit from wall before installing or removing the device or servicing unit

<sup>1</sup> Available from Kramer Electronics on our Web site at <http://www.kramerelectronics.com>

## 4 Your VS-211HDxl 3G HD-SDI Automatic Standby Switcher

Figure 1 and Table 1 define the VS-211HDxl:

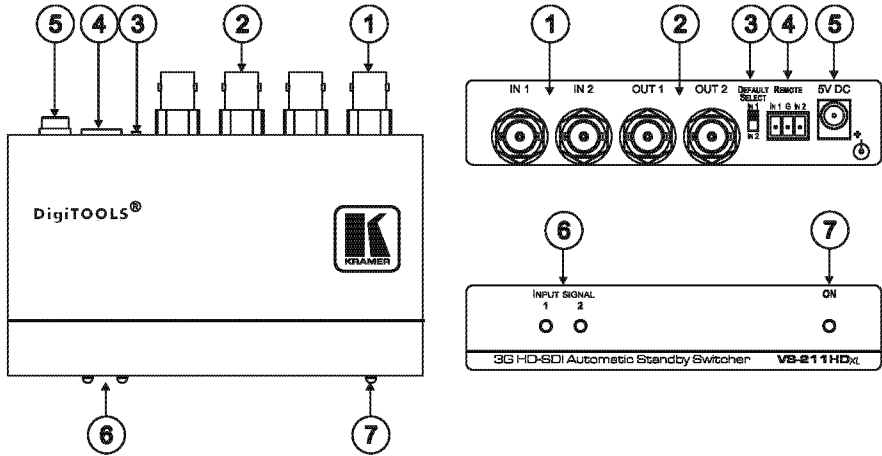

Figure 1: VS-211HDxl 3G HD-SDI Automatic Standby Switcher

Table 1: VS-211HDxl 3G HD-SDI Automatic Standby Switcher Features

#	Feature	Function
1	IN 1, IN 2 BNC Connectors	Connect the SDI input sources 1 and 2
2	OUT 1, OUT 2 BNC Connectors	Connect the SDI output acceptors 1 and 2
3	DEFAULT INPUT Switch	Switch to select the default input (IN 1 or IN 2)
4	REMOTE IN 1 and IN 2 Terminal Block Connectors	Connect to a contact closure switch
5	5V DC	+5V DC connector for powering the unit
6	INPUT SIGNAL 1,2 LEDs	Illuminates when input is active
7	ON LED	Illuminates when receiving power

## 5 Using the VS-211HDxl

This section describes how to:

- Connect the **VS-211HDxl** (see section [5.1](#))
- Select the default master source signal (see section [5.2](#))
- Connect the REMOTE connector (see section [5.3](#))

### 5.1 Connecting the VS-211HDxl 3G HD-SDI Automatic Standby Switcher

To connect the **VS-211HDxl**, as illustrated in the example in [Figure 2](#), do the following<sup>1</sup>:

1. Connect SDI input source 1 (for example, SDI video camera 1) to the IN 1 BNC connector.
2. Connect SDI input source 2 (for example, SDI video camera 2) to the IN 2 BNC connector.
3. Connect SDI acceptor 1 (for example, SDI display 1) to the OUT 1 BNC connector.
4. Connect SDI acceptor 2 (for example, SDI display 2) to the OUT 2 BNC connector.
5. Set the DEFAULT INPUT switch to whichever input is the master input, as described in section [5.2](#).
6. If needed, connect remote switches to the REMOTE IN 1 and IN 2 terminal block connectors, as described in section [5.3](#).
7. Connect the 5V DC power adapter to the power socket and connect the adapter to the mains electricity.

---

<sup>1</sup> Switch OFF the power on each device before connecting it to your VS-211HDxl. After powering up your VS-211HDxl, switch on the power on each device

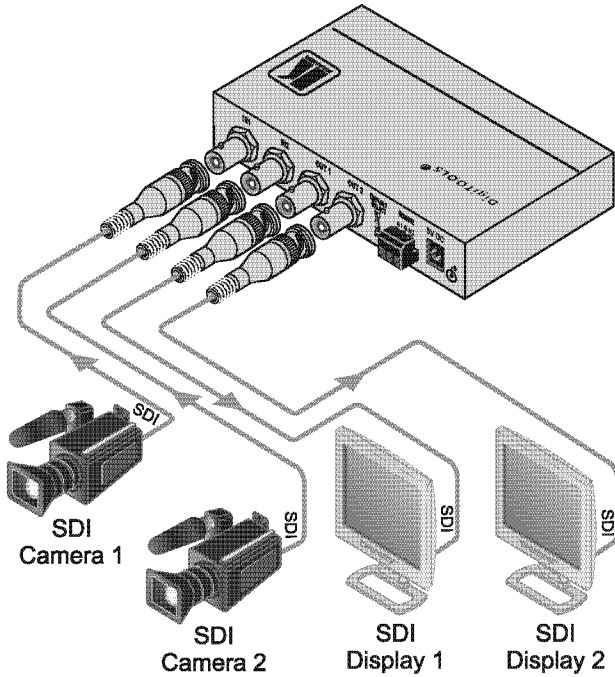

Figure 2: VS-211HDxl 3G HD-SDI Automatic Standby Switcher Connections

## 5.2 Selecting the Default Master Source Signal

When active input sources are connected to IN 1 and IN 2, the DEFAULT INPUT switch setting determines the default master input source.

- If the master input signal is not detected, the **VS-211HDxl** automatically activates the standby input
  - If IN 1 is the default input and it fails, IN 2 activates
  - If IN 2 is the default input and it fails, IN 1 activates
- If the master input reactivates while the standby input is active, the unit automatically switches back to the master input
  - If IN 2 is active while IN 1 is the default input and IN 1 reactivates, IN 1 reactivates
  - If IN 1 is active while IN 2 is the default input and IN 2 reactivates, IN 2 reactivates



### 5.3 Connecting the REMOTE Terminal Block Connector

Regardless of the default input switch setting, you can force the switching of the active input by remote control. To do this, connect the appropriate REMOTE input terminal block connector pins to a contact closure switch<sup>1</sup> (see [Figure 3](#)).

- To force IN 1: connect REMOTE IN1 to PIN G (ground)
- To force IN 2: connect REMOTE IN2 to PIN G (ground)

Do not connect both the REMOTE IN1 and the REMOTE IN2 to PIN G simultaneously

Attach PIN IN1 to  
PIN G to activate  
INPUT 1

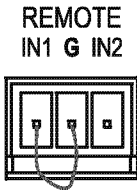

Attach PIN IN2 to  
PIN G to activate  
INPUT 2

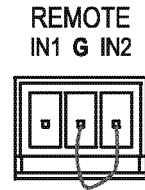

*Figure 3: REMOTE Terminal Block Connector*

<sup>1</sup> Note that the connection should be permanent, since the VS-211HDxl reverts to an automatic switcher when the connection is removed

## 6 Technical Specifications

Table 2 includes the technical specifications:

*Table 2: Technical Specifications<sup>1</sup> of the VS-211HDxl*

INPUTS:	2 x 3G HD-SDI video on BNC connectors
OUTPUTS:	2 x 3G HD-SDI video on BNC connectors
MAX. OUTPUT LEVEL:	800mV <sub>pp</sub> /75Ω
DATA RATE:	Up to 2.97Gbps
CONTROLS:	Contact closure remote control, input default selection switch
COUPLING:	AC
POWER SOURCE:	5V DC, 400mA
DIMENSIONS:	12cm x 7.2cm x 2.4cm (4.7" x 2.8" x 1.0") W, D, H
WEIGHT:	0.3kg (0.7lbs)
ACCESSORIES:	Power supply, mounting bracket
OPTIONS:	19" rack adapter

---

<sup>1</sup> Specifications are subject to change without notice

---

## LIMITED WARRANTY

Kramer Electronics (hereafter *Kramer*) warrants this product free from defects in material and workmanship under the following terms.

### HOW LONG IS THE WARRANTY

Labor and parts are warranted for seven years from the date of the first customer purchase.

### WHO IS PROTECTED?

Only the first purchase customer may enforce this warranty.

### WHAT IS COVERED AND WHAT IS NOT COVERED

Except as below, this warranty covers all defects in material or workmanship in this product. The following are not covered by the warranty:

1. Any product which is not distributed by Kramer, or which is not purchased from an authorized Kramer dealer. If you are uncertain as to whether a dealer is authorized, please contact Kramer at one of the agents listed in the Web site [www.kramerelectronics.com](http://www.kramerelectronics.com).
2. Any product, on which the serial number has been defaced, modified or removed, or on which the WARRANTY VOID IF TAMPERED sticker has been torn, reattached, removed or otherwise interfered with.
3. Damage, deterioration or malfunction resulting from:
  - i) Accident, misuse, abuse, neglect, fire, water, lightning or other acts of nature
  - ii) Product modification, or failure to follow instructions supplied with the product
  - iii) Repair or attempted repair by anyone not authorized by Kramer
  - iv) Any shipment of the product (claims must be presented to the carrier)
  - v) Removal or installation of the product
  - vi) Any other cause, which does not relate to a product defect
  - vii) Cartons, equipment enclosures, cables or accessories used in conjunction with the product

### WHAT WE WILL PAY FOR AND WHAT WE WILL NOT PAY FOR

We will pay labor and material expenses for covered items. We will not pay for the following:

1. Removal or installations charges.
2. Costs of initial technical adjustments (set-up), including adjustment of user controls or programming. These costs are the responsibility of the Kramer dealer from whom the product was purchased.
3. Shipping charges.

### HOW YOU CAN GET WARRANTY SERVICE

1. To obtain service on you product, you must take or ship it prepaid to any authorized Kramer service center.
2. Whenever warranty service is required, the original dated invoice (or a copy) must be presented as proof of warranty coverage, and should be included in any shipment of the product. Please also include in any mailing a contact name, company, address, and a description of the problem(s).
3. For the name of the nearest Kramer authorized service center, consult your authorized dealer.

### LIMITATION OF IMPLIED WARRANTIES

All implied warranties, including warranties of merchantability and fitness for a particular purpose, are limited in duration to the length of this warranty.

### EXCLUSION OF DAMAGES

The liability of Kramer for any effective products is limited to the repair or replacement of the product at our option. Kramer shall not be liable for:

1. Damage to other property caused by defects in this product, damages based upon inconvenience, loss of use of the product, loss of time, commercial loss; or
2. Any other damages, whether incidental, consequential or otherwise. Some countries may not allow limitations on how long an implied warranty lasts and/or do not allow the exclusion or limitation of incidental or consequential damages, so the above limitations and exclusions may not apply to you.

This warranty gives you specific legal rights, and you may also have other rights, which vary from place to place.

**NOTE:** All products returned to Kramer for service must have prior approval. This may be obtained from your dealer.

This equipment has been tested to determine compliance with the requirements of:

- EN-50081: "Electromagnetic compatibility (EMC); generic emission standard.  
Part 1: Residential, commercial and light industry"
- EN-50082: "Electromagnetic compatibility (EMC) generic immunity standard.  
Part 1: Residential, commercial and light industry environment".
- CFR-47: FCC\* Rules and Regulations:  
Part 15: "Radio frequency devices  
Subpart B Unintentional radiators"

### CAUTION!

- Servicing the machines can only be done by an authorized Kramer technician. Any user who makes changes or modifications to the unit without the expressed approval of the manufacturer will void user authority to operate the equipment.
- Use the supplied DC power supply to feed power to the machine.
- Please use recommended interconnection cables to connect the machine to other components.  
\* FCC and CE approved using STP cable (for twisted pair products)



---

For the latest information on our products and a list of Kramer distributors, visit our Web site: [www.kramerelectronics.com](http://www.kramerelectronics.com), where updates to this user manual may be found. We welcome your questions, comments and feedback.



**Caution**

**Safety Warning:**

Disconnect the unit from the power supply before opening/servicing.



---

**Kramer Electronics, Ltd.**

Web site: [www.kramerelectronics.com](http://www.kramerelectronics.com)

E-mail: [info@kramere.com](mailto:info@kramere.com)

P/N: 2900-000499 REV 2