

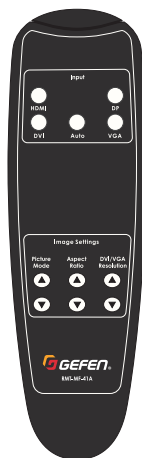

4K Ultra HD HDBaseT™

Multi-Format 4x1 Scaler w/ Auto-Switching & HDBaseT™ Output
HDBaseT™ Receiver w/ Audio-De-Embedder and POH

EXT-4K300A-MF-41-HBTL S
EXT-UHDA-HBTL-RX



User Manual
Version A1

Important Safety Instructions

1. Read these instructions.
2. Keep these instructions.
3. Heed all warnings.
4. Follow all instructions.
5. Do not use this product near water.
6. Clean only with a dry cloth.
7. Do not block any ventilation openings. Install in accordance with the manufacturer's instructions.
8. Do not install or place this product near any heat sources such as radiators, heat registers, stoves, or other apparatus (including amplifiers) that produce heat.
9. Do not defeat the safety purpose of the polarized or grounding-type plug. A polarized plug has two blades with one wider than the other. A grounding type plug has two blades and a third grounding prong. The wide blade or the third prong are provided for your safety. If the provided plug does not fit into your outlet, consult an electrician for replacement of the obsolete outlet.
10. Protect the power cord from being walked on or pinched particularly at plugs, convenience receptacles, and the point where they exit from the apparatus.
11. Only use attachments/accessories specified by the manufacturer.
12. To reduce the risk of electric shock and/or damage to this product, never handle or touch this unit or power cord if your hands are wet or damp. Do not expose this product to rain or moisture.
13. Unplug this apparatus during lightning storms or when unused for long periods of time.
14. Refer all servicing to qualified service personnel. Servicing is required when the apparatus has been damaged in any way, such as power-supply cord or plug is damaged, liquid has been spilled or objects have fallen into the apparatus, the apparatus has been exposed to rain or moisture, does not operate normally, or has been dropped.
15. Batteries that may be included with this product and/or accessories should never be exposed to open flame or excessive heat. Always dispose of used batteries according to the instructions.

Warranty Information

For the latest warranty coverage information, refer to the Warranty and Return Policy under the Connect section of the Gefen website at <http://www.gefen.com/connect/warranty-and-return-policy>

Technical Support

1-707-283-5900 1-800-472-5555
8:00 AM to 5:00 PM Monday - Friday, Pacific Time

Email

support@gefen.com

Web

<http://www.gefen.com>

Mailing Address

Gefen
Nortek Security & Control, LLC
c/o Customer Service
1800 S McDowell Blvd
Petaluma, CA 94954 USA

© 2018 Nortek Security & Control, LLC. All Rights Reserved.

All trademarks are the property of their respective owners.

Gefen and Nortek Security & Control, LLC reserve the right to make changes in the hardware, packaging, and any accompanying documentation without prior notice.

Important

- While Unshielded (UTP) CAT-5e is usually adequate, shielded (STP) CAT-6A is recommended. Shielded (STP) CAT-5e or unshielded (UTP) CAT-5e or CAT-6A may be acceptable depending on cable quality. Care should always be given to keep these cables away from power lines and other sources of electromagnetic interference.
- Cable quality is critical when handling HDMI, DVI, and DisplayPort™ signals. We highly recommend Gefen HDMI, DVI, and DisplayPort™ cables. They have been designed and tested to reliably transport the the full throughput of HDMI and DisplayPort™ standards.
- Power Over HDBaseT (POH) is a standard HDBaseT™ implementation of PoE that provides power from one device to the other over the link cable. This Swither and Receiver units comply with the POH standard. Please note that he EXT-4K300A-MF-41-HBTLs can power the EXT-UHDA-HBTL-RX the Receiver, but the EXT-UHDA-HBTL-RX Receiver unit **cannot** power the EXT-4K300A-MF-41-HBTLs Switcher.
- The EXT-4K300A-MF-41-HBTLs and the EXT-UHDA-HBT-RX, when used together, can pass both HDCP 2.2 and 1.4 through the HDMI and DisplayPort™ inputs. The DVI input can pass HDCP 1.4 only.
- The information in this manual has been carefully checked and is believed to be accurate. However, Gefen and Nortek Security & Control, LLC assume no responsibility for any inaccuracies that may be contained in this manual. In no event will Gefen and Nortek Security & Control, LLC be liable for direct, indirect, special, incidental, or consequential damages resulting from any defect or omission in this manual.
- All information contained herein is subject to change without notice.



This product may use software that is subject to open source licenses, including one or more of the General Public License Version 2 and Version 2.1, Lesser General Public License Version 2.1 and Version 3, BSD, and BSD-style licenses. Distribution and use of this product is subject to the license terms and limitations of liability provided in those licenses. Specific license terms and Copyright Notifications are provided in the source code.

For three years from date of activation of this product, any party may request, and we will supply, for software covered by an applicable license (e.g. GPL or LGPL), a complete machine-readable copy of the corresponding open source code on a medium customarily used for software interchange. The following software and libraries are included with this product and subject to their respective open source licenses:

- lwIP
- jQuery

lwIP is licenced under the BSD licence:

Copyright (c) 2001-2004 Swedish Institute of Computer Science.
All rights reserved.

Redistribution and use in source and binary forms, with or without modification, are permitted provided that the following conditions are met:

1. Redistributions of source code must retain the above copyright notice, this list of conditions and the following disclaimer.
2. Redistributions in binary form must reproduce the above copyright notice, this list of conditions and the following disclaimer in the documentation and/or other materials provided with the distribution.
3. The name of the author may not be used to endorse or promote products derived from this software without specific prior written permission.

THIS SOFTWARE IS PROVIDED BY THE AUTHOR ``AS IS'' AND ANY EXPRESS OR IMPLIED WARRANTIES, INCLUDING, BUT NOT LIMITED TO, THE IMPLIED WARRANTIES OF MERCHANTABILITY AND FITNESS FOR A PARTICULAR PURPOSE ARE DISCLAIMED. IN NO EVENT SHALL THE AUTHOR BE LIABLE FOR ANY DIRECT, INDIRECT, INCIDENTAL, SPECIAL, EXEMPLARY, OR CONSEQUENTIAL DAMAGES (INCLUDING, BUT NOT LIMITED TO, PROCUREMENT OF SUBSTITUTE GOODS OR SERVICES; LOSS OF USE, DATA, OR PROFITS; OR BUSINESS INTERRUPTION) HOWEVER CAUSED AND ON ANY THEORY OF LIABILITY, WHETHER IN CONTRACT, STRICT LIABILITY, OR TORT (INCLUDING NEGLIGENCE OR OTHERWISE) ARISING IN ANY WAY OUT OF THE USE OF THIS SOFTWARE, EVEN IF ADVISED OF THE POSSIBILITY OF SUCH DAMAGE.

EXT-4K300A-MF-41-HBTLs*

- Automatic switching of the 4 video inputs
- Manual switching of video inputs via front panel button, handheld IR remote, electrical IR, or RS-232
- Split HDMI and HDBaseT™ Outputs feed local and remote displays simultaneously
- Inputs:
 - 1x HDMI
 - 1x DisplayPort™
 - 1x DVI
 - 1x VGA
 - 1x L/R Analog Audio
- Outputs:
 - 1x HDMI
 - 1x HDBaseT™
 - 1x L/R Analog Audio
- Supports up to 340 MHz TMDS clock and 10.2 Gbps data throughput
- VGA and DVI feature scaling up to WUXGA (1920 x 1200 at 60 Hz) and 1080p Full HD (60 Hz) with picture adjustment capabilities
- DVI input can be associated with the L/R Analog Audio Input or with audio embedded in the video
- When used with optional EXT-UHDA-HBTL-RX HDBaseT™ Receiver, extends the HDMI output, outbound IR, and RS-232 over a single CAT-5e:
 - 4K Ultra HD (3840 x 2160 @ 60 Hz, 4:2:0), up to 130 feet/40 meters (8-bit color)
 - 4K Cinema-DCI (4096 x 2160 @ 24 or 30 Hz 4:4:4), up to 130 feet/40 meters (8-bit color)
 - 1080p Full HD (60 Hz) or WUXGA (1920x1200 @ 60 Hz), up to 230 feet/70 meters (up to 12-bit Deep Color)
- HDMI features supported:
 - HDMI 2.0
 - HDCP 2.2 and 1.4
 - 12-bit Deep Color (at 1080p)
 - LPCM 7.1, Dolby Atmos®, Dolby® TrueHD, DTS:X™, and DTS-HD Master Audio™ pass-through
 - 3DTV pass-through
 - CEC pass-through
 - Lip Sync pass-through

- DisplayPort™ features supported:
 - DP 1.1
 - HDCP 2.2 and 1.4
- DVI input supported formats:
 - DVI-D, HDMI 1.4, VGA, YPbPr (Component Video), and Composite Video
 - HDCP 1.4 (for DVI-D and HDMI signals)
- VGA input supported formats:
 - VGA, YPbPr (Component Video), and Composite Video
- RS-232 extension or unit control
- IR extension (outbound only) or unit control
- Analog L/R audio breakout
- Dry contact for input switching with indicator LED +5V power source
- Uses Gefen's implementation of HDBaseT™ technology with enhanced features
- Advanced EDID Management for rapid integration of source and display
- Field-updateable firmware via micro-USB port, using the Gefen Syner-G™ software
- Locking HDMI connectors
- Locking power connector
- Power over HDBaseT™ (POH) provides power to a compatible Receiver unit (such as EXT-UHDA-HBTL-RX) over the link cable
- IR In/Ext port works with Gefen EXT-RMT-EXTIRN IR Extender Module or electrical IR from a third-party controller
- Compact, ultra-low-profile enclosure is surface-mountable and can be hidden away

*Features and specifications are subject to change without notice.

All trademarks and registered trademarks are properties of their respective owners.

EXT-UHDA-HBTL-RX*

- Supports 340 MHz TMDS Clock and data throughput of up to 10.2 Gbps
- Extends HDMI, 2-way IR, and RS-232 over a single CAT-5e:
 - 4K Ultra HD (3840 x 2160 @ 60 Hz, 4:2:0), up to 130 ft/40 m (8-bit color)
 - 4K Ultra HD (3840 x 2160 @ 30 Hz, 4:4:4), up to 130 ft/40 m (8-bit color)
 - 4K Cinema-DCI (4096 x 2160 @ 24 or 30 Hz 4:4:4), up to 130 ft/40 m (8-bit color)
 - 1080p Full HD (60 Hz) or WUXGA (1920x1200 @ 60 Hz), up to 230 ft/70 m (up to 12-bit Deep Color)
- HDMI Features Supported:
 - HDMI 2.0
 - HDCP 2.2 and 1.4
 - 12-bit Deep Color (at 1080p)
 - LPCM 7.1, Dolby Atmos®, Dolby® TrueHD, DTS:X™, and DTS-HD Master Audio™ pass-through
 - 3DTV pass-through
 - CEC pass-through
 - Lip Sync pass-through
- RS-232 control of switching, scaler, and EDID management functions of a compatible Sender (such as EXT-UHDV-HBTL-TX or EXT-UHDV-WP-HBTL-TX)
- Bi-Directional RS-232 extension when used with a compatible Sender
- 2-way IR extension when used with EXT-UHDV-HBTL-TX and EXT-4K300A-MF-41-HBTL
- Digital (optical and coaxial) and Analog audio breakout
- Bi-Directional Power over HDBaseT™ (POH) provides power to the Receiver or a compatible Sender unit over the link cable - only one side will need external power
- Uses Gefen's implementation of HDBaseT™ technology with enhanced features
- Locking power connector
- Compact, ultra-low-profile enclosure is surface-mountable and can be hidden away

*Features and specifications are subject to change without notice.

EXT-4K300A-MF-41-HBTLS*

The following items are included in the EXT-4K300A-MF-41-HBTLS package. If any of these items are not present in the box when you first open it, please contact Gefen Technical Support as soon as possible.

- (1) 4K Ultra HD Multi-Format 4x1 Scaler w/ Auto-Switching and HDBaseT™ Output
- (1) 12V DC power supply with locking connector and US/EU/UK/AU Regional Plugs
- (1) EXT-RMT-EXTIRN IR Extender
- (1) RMT-MF-41A Handheld IR Remote with 2 AAA batteries
- (2) 3-pin Phoenix plugs (attached to unit)
- (2) Mounting Brackets
- (4) Self-adhesive rubber feet
- (1) Quick Start Guide

EXT-UHDA-HBTL-RX*

The following items are included in the EXT-UHDA-HBTL-RX. If any of these items are not present in the box when you first open it, please contact Gefen Technical Support as soon as possible.

- (1) 4K Ultra HD HDBaseT™ Receiver unit
- (1) 12V DC power supply with locking connector and US/EU/UK/AU Regional Plugs
- (1) 3-pin Phoenix plug (attached to unit)
- (2) Mounting Brackets
- (4) Self-adhesive rubber feet
- (1) Quick-Start Guide

*Features and specifications are subject to change without notice.

All trademarks and registered trademarks are properties of their respective owners.

Table of Contents

- Controls, Connectors, and Indicators..... 12**
 - EXT-4K300A-MF-1-HBTLS 12
 - RMT-MF-41A..... 16
 - EXT-UHDA-HBTL-RX..... 18

- Installation 21**
 - Physical Installation, EXT-4K300A-MF-41-HBTLS 21
 - Physical Installation, EXT-UHDA-HBTL-RX..... 21
 - Sample Wiring Diagram..... 22
 - Input Control Switch Wiring..... 22

- LED Status..... 23**

- Scaler Functions and Picture Adjustments..... 24**

- EDID Management 25**

- RS-232 26**
 - Features 26
 - Commands 29

- IR Control 32**
 - Controlling the Display from the Source Location 32
 - Controlling the EXT-4K300A-MF-41-HBTLS Locally 33

- Firmware Update 34**

- Specifications 35**

EXT-4K300A-MF-41-HBTL5

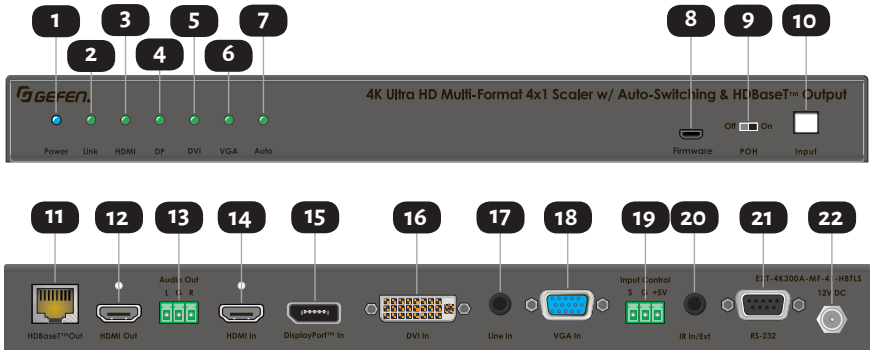

ID	Name	Description
1	Power Indicator	This LED indicator glows solid blue when the unit is powered. See LED Status (Page 23) for more information.
2	Link Indicator	This LED glows solid green when a link is established between the Sender and Receiver. See LED Status (Page 23) for more information.
3	HDMI Indicator	This LED indicator glows solid green when the HDMI input has been selected. See LED Status (Page 23) for more information.
4	DP Indicator	This LED indicator glows solid green when the DisplayPort™ input has been selected. See LED Status (Page 23) for more information.
5	DVI Indicator	This LED indicator glows solid green when the DVI input has been selected. See LED Status (Page 23) for more information.
6	VGA Indicator	This LED indicator glows solid green when the VGA input has been selected. See LED Status (Page 23) for more information.
7	Auto Indicator	This LED indicator glows solid green when the Automatic Switching is active. See LED Status (Page 23) for more information.

ID	Name	Description
8	Firmware	To do a firmware update, attach a USB thumb drive containing the new firmware to this port, using a USB Micro-B male to USB Type-A female cable or adaptor. The Gefen Syner-C™ software, running on a PC connected to the RS-232 port of the 4x1 Switcher (Page 34) will administer the firmware update process.
9	POH	When using an HDBaseT™ Receiver that complies with the Power-Over-HDBaseT (POH) standard, place the POH slide switch on the front panel to On by sliding it to the right. Please remember that POH is a HDBaseT™ standard. Receivers specified as POL, POC, or POE may not be POH-compliant. If using a non-POH-compliant Receiver or not using an HDBaseT Receiver at all, this switch should be left in Off position (slide to left).
10	Input/Auto Switch	To switch between HDMI, DisplayPort™, DVI, and VGA inputs, press and release this button. To activate or deactivate Auto-Switching, press and hold this button for 3 seconds or longer until the function engages or disengages. The Auto LED (see 7 on previous page) will be illuminated when Auto-Switching is active. See LED Status (Page 23) for more info.
11	HDBaseT™ Out	Connect a CAT-5e or better cable, up to the recommended length for a given resolution, from this port to the HDBaseT™ In port of the Receiver unit. This Switcher can send power to the EXT-UHDA-HBTL-RX or another POH-compatible Receiver over the CAT-5 cable, but it cannot receive power from it.
12	HDMI Out	Use a Gefen HDMI cable to connect an HDMI display to this port.
13	Audio Output	This port provides analog Left and Right channels of audio de-embedded from the HDMI Output signal, for use with outboard amplification. Connect a 3.5mm stereo audio cable from this port to the analog stereo input of your amplifier or processor. Connect to Left, Right, and Ground inputs of an analog amplifier or processor, using the removable 3-pin “Captive Screw” Phoenix connector.

ID	Name	Description
14	HDMI In	Connect a Gefen HDMI cable from your source to this input.
15	DisplayPort™ In	Connect a Gefen DisplayPort™ cable from your source to this input.
16	DVI In	Connect a Gefen DVI cable from your source to this input.
17	Line In	Use an audio cable with 3.5mm stereo plugs to connect your DVI or VGA or a separate audio source to the Line In port of the 4x1 Switcher. The Line In audio port accompanies both the VGA and DVI signals, but the DVI in port can be reconfigured via RS-232 to accept audio that is embedded in the video signal.
18	VGA In	Connect a VGA cable from your source to this input.
19	Input Control	This connector can be used with a momentary switch, where each press and release of the button would switch to the next input. This switch should be connected between the S and G pins. The +5V pin can be used to light an LED to confirm each button press. Please see Input Control Switch Wiring (page 22) .
20	IR In/Ext	This port can be configured to extend IR from the source side to the viewing location over the HDBaseT™ cable, so that the remote display or another remotely located device can be controlled from the source side using the display's IR remote or a third-part controller. Instead of providing IR extension to the Receiver, this port can also be configured to control the unit itself using the included IR remote. Configuration is done via RS-232 commands. Connect the included EXT-RMT-EXTIRN IR Extender module or the IR output of an automation control device (using a patch cable with stereo or mono 3.5mm mini-phone plugs on both ends) to the IR In/Ext port. Please note that the 4x1 Switcher cannot receive IR from the Receiver. The IR In/Ext port on the Receiver is therefore not used in this system combination.

ID	Name	Description
21	RS-232	<p>This port can be configured to extend 2-way RS-232 communications between the unit and the Receiver over the HDBaseT™ cable. Using this feature, the remote display can be controlled from the source side by an RS-232 control device, or the source can be controlled from the remote location. This port can also be configured to control the 4x1 Switcher itself instead of providing extension. Configuration is done via RS-232 commands. Connect an RS-232-enabled device to the 4x1 Switcher using a DB-9 cable.</p>
22	12V DC In	<p>This power receptacle is used to connect the included 12V DC power supply. When used with a POH-compliant Receiver such as the EXT-UHDA-HBTL-RX, the Receiver can receive power from this 4x1 Switcher through the HDBaseT™ Link (CAT-5) cable.</p>

RMT-MF-41A

Handheld IR Remote for EXT-4K300A-MF-41-HBTLS

NOTE: When using this IR remote, please make sure that there is unobstructed, clear line of sight from the remote's front to the EXT-RMT-EXTIRN IR Extender Module that is connected to the 4x1 Switcher.

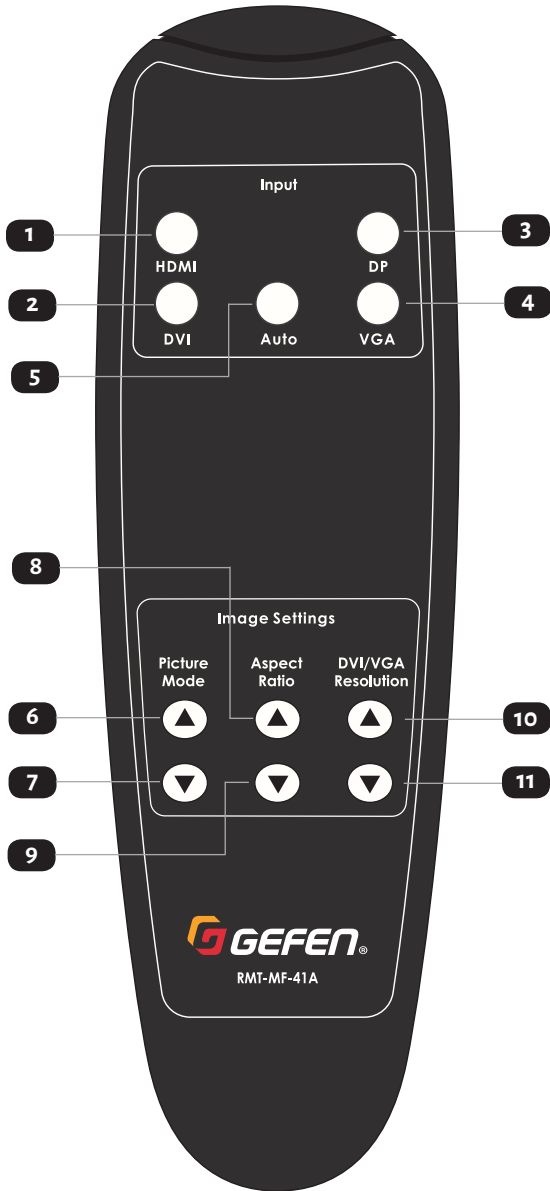

ID	Name	Description
1	HDMI	Press and release this button to select the HDMI input.
2	DVI	Press and release this button to select the DVI input.
3	DP	Press and release this button to select the DisplayPort™ input.
4	VGA	Press and release this button to select the VGA input.
5	Auto	Press and release this button to enter and exit the Auto-Switching mode.
6 & 7	DVI/VGA Picture Mode	Press and release either of these two buttons to scroll through the available Picture Modes: Dynamic Standard Vivid User
8 & 9	DVI/VGA Aspect Ratio	Press and release either of these two buttons to scroll through the available Aspect Ratio settings: 16:9 4:3 Auto
10 & 11	DVI/VGA Resolution	Press and release either of these two buttons to scroll through the available resolutions for the DVI and VGA pictures: 1360 x 768 60 Hz 1024 x 768 60 Hz 1280 x 720 50 Hz 1280 x 720 60 Hz 1280 x 800 60 Hz 1600 x 1200 60 Hz 1920 x 1080 50 Hz 1920 x 1080 60 Hz 1920 x 1200 60 Hz

EXT-UHDA-HBTL-RX

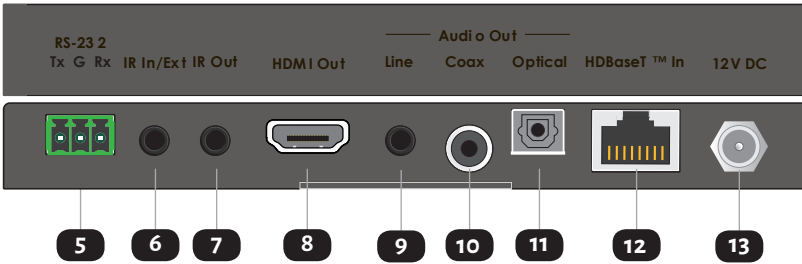

ID	Name	Description
1	RS-232/Program Switch	This 3-position slide switch places the unit in RS-232 extension or factory service modes (Prog 1 and Prog 2). During normal operation, this switch should be in “RS-232 Pass-Thru” (middle) position.
2	Link Indicator	This LED glows solid green when a link is established between the 4x1 Switcher and the Receiver. See LED Status (Page 23) for more information.
3	HDCP Indicator	This LED indicator glows solid green when the active HDMI, DisplayPort™, or DVI signal contains HDCP encryption. See LED Status (Page 23) for more information.
4	Power Indicator	This LED indicator glows solid blue when the unit is powered. See LED Status (Page 23) for more information.

ID	Name	Description
5	RS-232 Port	This port can be used for extending 2-way RS-232 communications between the 4x1 Switcher and the Receiver. Connect Tx, Rx, and Ground from an automation control device or an RS-232 device-to-be-controlled, using the removable 3-pin “Captive Screw” Phoenix connector. To ensure proper operation, please follow the pin-out of the connector as printed on each unit's enclosure.
6	IR In/Ext	This port is not used when connected to the EXT-4K300A-MF-41-HBTL: 3.5mm mini-stereo jack. Connect an IR Extender (Gefen part no. EXT-RMT-EXTIRN, sold separately) to this port. Alternatively, connect a 3.5mm mini-stereo connector from this port to the output of an automation system with an electrical IR output.
7	IR Out	Connect an EXT-IREMIT IR Emitter (sold separately) from this port to the IR sensor of the device to be controlled.
8	HDMI Out	Use a Gefen HDMI cable to connect an HDMI display to this port.
9	Line Out	This port provides analog Left and Right channels of audio de-embedded from the HDMI signal, for use with outboard amplification. Connect a 3.5mm stereo audio cable from this port to the analog stereo input of your amplifier or processor.

ID	Name	Description
10	Coaxial Digital Out	This port provides up to 5.1 channels of Bitstream (Dolby Digital or DTS), or Left and Right channels of PCM digital audio de-embedded from the HDMI signal, for use with outboard amplification. Connect a coaxial digital audio cable with RCA connectors from this port to the coaxial digital input of your amplifier or processor.
11	Optical Digital Out	This port provides up to 5.1 channels of Bitstream (Dolby Digital or DTS), or Left and Right channels of PCM digital audio de-embedded from the HDMI signal, for use with outboard amplification. Connect an optical digital audio cable with TOSLINK® connectors from this port to the optical digital input of your amplifier or processor.
12	HDBaseT™ In (Link) Connector	Connect a CAT-5e or better cable, up to the recommended length for a given resolution, from this port to the HDBaseT™ Out port on the Sender unit. This Receiver can send power over the CAT-5 cable to some POH compliant Sender units but NOT the EXT-4K300A-MF-41-HBTLs. It can also receive power over the CAT-5 cable from a POH compatible Sender such as the EXT-UHDV-HBTLs-TX and EXT-4K300A-MF-41-HBTLs, but NOT the EXT-UHDV-WP-HBTLs-TX.
13	12V DC In	This power receptacle is used to connect the included 12V DC power supply.

Physical Installation

EXT-4K300A-MF-41-HBTLS:

1. The 4x1 Switcher's low-profile enclosure can be surface-mounted using a pair of mounting brackets (included) that can be attached to each side of the enclosure using the provided screws. It can also be placed on a shelf.
2. When surface-mounting the Sender, please secure it to the mounting surface using screws appropriate for that specific surface (not included with the product).

EXT-UHDA-HBTL-RX:

1. The Receiver's ultra-low-profile enclosure can be hidden behind the display. It also features a pair of mounting brackets (included) that can be attached to each side of the enclosure using the provided screws.
2. When surface-mounting the Receiver, please secure it to the mounting surface using screws appropriate for that specific surface (not included with the product).

Sample Wiring Diagram

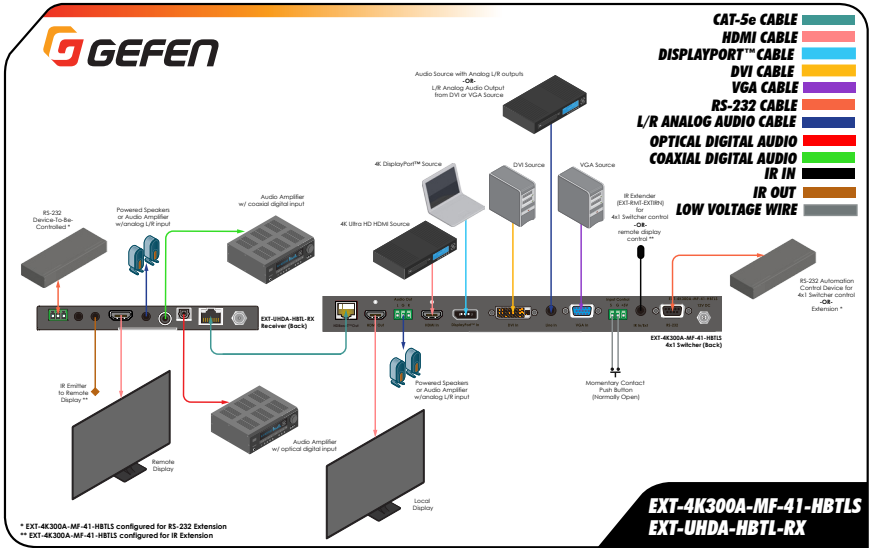

Notes

1. The wiring diagram above shows cables and accessories that may not be included with the products. Select accessories (as identified by Gefen part numbers) are available for purchase from your Gefen distributor.
2. Power supply connections are not shown in the diagrams above.



Input Control Switch Wiring

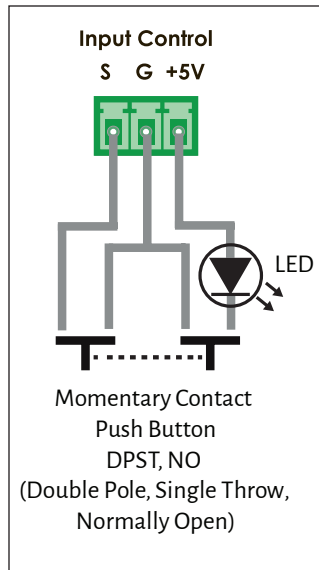

1. The **Input Control** terminal can be used for sequential switching of the 4 inputs of the EXT-4K300A-MF-41-HBTL5. It can also supply voltage to an LED to confirm each button press.
2. Select a suitable low voltage, DPST (Double Pole, Single Throw), NO (Normally Open), momentary push button that is capable of switching 5V DC at 15 mA or more. To wire an LED to indicate button press, you also will need an LED.
3. Remove the Phoenix plug that came attached to the **Input Control** terminal, and connect the DPST switch and the LED to it as shown to the right, using 22-gauge Low Voltage wire. Reconnect the Phoenix plug to the 4x1 Switcher.
4. Once installation is completed, each press and release of the push-button will light the indicator LED and the unit will switch to the next input.







LED Status



The **Power**, **Link**, **HDMI**, **DP**, **DVI**, **VGA**, and **Auto**, indicators on the 4x1 Switcher, and **Power**, **Link**, and **HDCP** indicators on the Receiver unit provide basic information on the current status of each unit.

Power		Description
Solid blue		<ul style="list-style-type: none">The unit is powered.
Off		<ul style="list-style-type: none">The unit is not powered. Check the power supply and the Link connection between the Sender and the Receiver unit.

Link		Description
Solid green		<ul style="list-style-type: none">Link integrity is good between the Sender and Receiver unit.
Off		<ul style="list-style-type: none">Link is not detected. Check the power supply and the Link connection between the Sender and the Receiver unit.

HDCP (Receiver only)		Description
Solid green		<ul style="list-style-type: none">The HDMI signal being extended between Sender and Receiver has HDCP Encryption.
Off		<ul style="list-style-type: none">Either the VGA or an unencrypted HDMI signal is being extended.

HDMI, DP, DVI, VGA (Sender only)		Description
Solid green		<ul style="list-style-type: none">The designated input is selected.
Off		<ul style="list-style-type: none">The designated input is not selected.

Auto* (Sender only)		Description
Solid green		<ul style="list-style-type: none">Automatic Input Switching is active.
Off		<ul style="list-style-type: none">Automatic Input Switching is off.

* To Enable/Disable Auto-Switching, press and hold the Input/Auto Button for 3 seconds or longer until the backlight turns on or off.

Scaler Functions and Picture Adjustments

The EXT-4K300A-MF-41-HBTLS features a powerful **Scaler that is active for DVI and VGA inputs only**. The HDMI and DP inputs are pass-thru.

The DVI and VGA input signals can be scaled to an array of resolutions, timing, and aspect ratios up to WUXGA (1920 x 1200) at 60 Hz, 4:4:4.

Scaler Output can be set to one of the following:

1. 1360 x 768 60 Hz
2. 1024 x 768 60 Hz
3. 1280 x 720 50 Hz
4. 1280 x 720 60 Hz
5. 1280 x 800 60 Hz
6. 1600 x 1200 60 Hz
7. 1920 x 1080 50 Hz
8. 1920 x 1080 60 Hz
9. 1920 x 1200 60 Hz

The aspect ratio can be set to 16:9, 4:3, or automatically follow the source to maintain the best possible picture at all times.

The EXT-4K300A-MF-41-HBTLS also features a large number of Picture Adjustment parameters such as Picture Modes (Dynamic, Standard, Vivid, and User), Contrast, Brightness, Saturation, Sharpness, Auto-Sync, Color Temperature, Color Balance, Image Shift, Image Stretch, Polarity, Clock and Phase adjustments.

All of the above scaler and picture adjustment parameters can be configured via RS-232 commands ([Page 29](#)) or Gefen Syner-G™ software.

EDID Management

The EXT-4K300A-MF-41-HBTLS also features advanced EDID Management capabilities for quick optimization of a source's output to best match the display's capabilities.

EDID Management can be done via RS-232 commands ([Page 29](#)) or using the Gefen Syner-G™ software.

When using Gefen Syner-G™, Internal, External, and Custom EDIDs can be downloaded from the EXT-4K300A-MF-41-HBTLS, modified via the advanced EDID Editor that is built into the Gefen Syner-G™ software, and uploaded back into the 4x1 Switcher.

RS-232 Features

The RS-232 port on the EXT-4K300A-MF-41-HBTLS can be configured to:

- EITHER -

(a) Accept commands for input switching, scaler functions, and EDID management of the EXT-4K300A-MF-41-HBTLS. This can be done via an automation control device or the Gefen Syner-G™ software.

-OR-

(b) When used with the EXT-UHDA-HBTL-RX Receiver, provide bi-directional RS-232 extension between the units over the CAT-5 Link cable.

Please see the RS-232 commands section ([Page 29](#)) on how to configure the Switcher to perform the above functions.

(a) Control of 4x1 Switcher's input switching, scaler functions, and EDID management from via its RS-232 port:

1. Using a DB-9 cable, connect the 4x1 Switcher's **RS-232** port to a computer with a Serial (RS-232) port. You will need to use a USB-to-RS-232 adaptor if your PC does not have a Serial port.
2. Establish Serial (RS-232) communications between the computer and the 4x1 Switcher. Send the **#SET_RS232_MODE 2** command to the Sender to place it in "Unit Control" mode. To revert the Sender to its default RS-232 extension mode, the RS-232 command **#SET_RS232_MODE 1** needs to be sent to the RS-232 port.
3. Disconnect the PC from the Sender unit. Connect an RS-232-enabled automation control device (a.k.a. third-party controller) to the **RS-232** port of the 4x1 Switcher. Make all other connections to the 4x1 Switcher as needed, and install it in its location.

Program your automation control device with the RS-232 control commands ([Page 29](#)) for the EXT-4K300A-MF-41-HBTLS. All commands sent to the **RS-232** port of the unit will now be executed by the 4x1 Switcher. They will not be extended to the Receiver unit.

(b). Bi-directional RS-232 extension between 4x1 Switcher and HDBaseT Receiver:

1. Using a DB-9 cable, connect the 4x1 Switcher's **RS-232** port to a computer with a Serial (RS-232) port. You will need to use a USB-to-RS-232 adaptor if your PC does not have a Serial port.
2. Establish Serial (RS-232) communications between the computer and the 4x1 Switcher. Send the **#SET_RS232_MODE 1** command to the Sender to place it in "RS-232 Pass-Thru" mode. To revert the Sender to its RS-232 "Unit Control" mode, the RS-232 command **#SET_RS232_MODE 2** needs to be sent to the RS-232 port.
3. Disconnect the PC from the Sender unit. Connect an RS-232-enabled automation control device (a.k.a. third-party controller) to the **RS-232** port of the 4x1 Switcher and an RS-232 device-to-controlled (such as the display) to the **RS-232** port of the Receiver unit. **Make sure that the Receiver's front panel 3-position slide switch is in "RS-232 Pass-Thru" (middle) position.** Make all other connections to the Switcher as needed, and install the Switcher and Receiver in their locations.

NOTE: Since RS-232 is a bi-directional communications protocol, you can also connect the automation controller to the Receiver and the device-to-be-controlled to the 4x1 Switcher, depending on your application.

c. Interface with Gefen Syner-G™ via RS-232 ports of 4x1 Switcher and Receiver.:

- 1. 4x1 Switcher:** Using a DB-9 cable, connect the 4x1 Switcher's **RS-232** port to a computer with a Serial (RS-232) port. You will need to use a USB-to-RS-232 adaptor if your PC does not have a Serial port. Run the Gefen Syner-G program on the PC. **If the Sender was configured to be in “RS-232 Extension” mode (see section (b) on previous page), first return it to its “Unit Control” mode by following step (2) of section (b).**
- 2. Receiver:** Since the Receiver does not have any customizable features , it cannot be used with Gefen Syner-G™.

RS-232 Commands (EXT-4K300A-MF-41-HBTLS)

Command Code	Description	Syntax
Help		
#HELP	LISTS ALL AVAILABLE TCP/UDP COMMANDS. IF A COMMAND IS SPECIFIED THEN BOTH THE DESCRIPTION AND SYNTAX WILL BE LISTED FOR THE COMMAND	#HELP PARAM: [OPTIONAL] PARAM = ANY TCP/UDP COMMAND (NO #)
Routing		
R	SELECT VIDEO INPUT BETWEEN HDMI, DISPLAYPORT, DVI, AND VGA	R PARAM PARAM = H, DP, D, V H - HDMI DP - DISPLAYPORT D - DVI V - VGA
S	CET SELECTED INPUT STATUS	S NO PARAMETER
#SET_INPUT_MODE	SET DVI OR VGA INPUT MODE (DVI OR VGA MODE CAN ONLY BE CHANGED WHEN THAT VIDEO INPUT IS SELECTED)	#SET_INPUT_MODE PARAM PARAM2 PARAM = D, V D - DVI V - VGA PARAM2 = 0 - 3 0 - NORMAL MODE 1 - YPBPR MODE 2 - COMPOSITE MODE 3 - VGA MODE (ONLY APPLICABLE WHEN PARAM IS DVI)
#GET_INPUT_MODE	CET DVI OR VGA INPUT MODE	#GET_INPUT_MODE PARAM PARAM = D, V, ALL D - DVI V - VGA ALL - LISTS INPUTS MODES IN ORDER OF DVI, VGA
#SET_DVI_AUDIO	SET DVI AUDIO SOURCE	#SET_DVI_AUDIO PARAM PARAM = 1 - 2 1 - EMBEDDED 2 - EXTERNAL
#GET_DVI_AUDIO	CET DVI AUDIO SOURCE	#GET_DVI_AUDIO
#SET_AUTO_SWITCH	ENABLE/DISABLE AUTO SWITCHING FEATURE	#SET_AUTO_SWITCH PARAM PARAM = 0 - 1 0 - DISABLED 1 - ENABLED
#GET_AUTO_SWITCH	CET THE ENABLE/DISABLE STATUS OF THE AUTO SWITCHING FEATURE	#GET_AUTO_SWITCH
MANAGE EDID		
#SET_EDID_MODE	SET INPUT EDID MODE (GLOBAL TO HDMI AND DP ONLY)	#SET_EDID_MODE PARAM PARAM = 1 - 6 1 - INTERNAL - 1080P 2 CH 2 - INTERNAL - 1080P MULTI-CH 3 - INTERNAL - 4K UHD 200 MHZ 2 CH 4 - INTERNAL - 4K UHD 200 MHZ MULTI-CH 5 - EXTERNAL (BYPASS MODE) 6 - CUSTOM MODE - USER
#GET_EDID_MODE	GET INPUT EDID MODE	#GET_EDID_MODE
#GET_INTERNAL_EDID	DOWNLOAD A PRESET INTERNAL EDID	#GET_INTERNAL_EDID PARAM PARAM = 1 - 4 1 = INTERNAL - 1080P 2 CH 2 = INTERNAL - 1080P MULTI-CH 3 = INTERNAL - 4K UHD 200 MHZ 2 CH 4 = INTERNAL - 4K UHD 200 MHZ MULTI-CH
#GET_EXTERNAL_EDID	DOWNLOAD EXTERNAL (BYPASS) EDID	#GET_EXTERNAL_EDID
#GET_CUSTOM_EDID	DOWNLOAD THE CUSTOM USER EDID	#GET_CUSTOM_EDID
#SEND_CUSTOM_EDID	UPLOAD A CUSTOM USER EDID FOR USE WITH CUSTOM MODE	#SEND_CUSTOM_EDID
#SET_EDID_LOCK	SET INPUT EDID LOCK (PREVENTS ACCIDENTAL CUSTOM EDID OVERWRITE)	#SET_EDID_LOCK PARAM PARAM = 0 - 1 0 - DISABLED 1 - ENABLED
#GET_EDID_LOCK	GET INPUT EDID LOCK STATUS	#GET_EDID_LOCK
SYSTEM SETTINGS		
#FIRMWARE_UPDATE	PERFORM FIRMWARE UPDATE	#FIRMWARE_UPDATE
#GET_FIRMWARE_VERSION	CET FIRMWARE VERSION	#GET_FIRMWARE_VERSION
#FACTORY_RESET	RESET TO FACTORY DEFAULTS	#FACTORY_RESET
#REBOOT	REBOOT THE UNIT	#REBOOT

Command Code	Description	Syntax
Setup		
#SET_RS232_MODE	SET THE RS-232 OPERATING MODE	#SET_RS232_MODE PARAMn PARAMn = 1-2 1 - RS-232 PASS-THROUGH 2 - CONTROL OF UNIT FROM CONNECTED SERIAL DEVICE
#CET_RS232_MODE	CET THE RS-232 OPERATING MODE	#CET_RS232_MODE
#SET_RS232_BAUD	SET THE RS-232 COMMUNICATION BAUD RATE	#SET_RS232_BAUD PARAMn PARAMn = 0 - 6 0 - 115200 1 - 57600 2 - 38400 3 - 19200 4 - 9600 5 - 4800 6 - 2400
#CET_RS232_BAUD	CET THE RS-232 COMMUNICATION BAUD RATE	#CET_RS232_BAUD
#SET_IR_MODE	SET THE IR OPERATING MODE	#SET_IR_MODE PARAMn PARAMn = 1-2 1 - IR PASS-THROUGH 2 - CONTROL OF UNIT FROM INCLUDED REMOTE CONTROL
#CET_IR_MODE	CET THE IR OPERATING MODE	#CET_IR_MODE
#SET_OUTPUT_RES	SET OUTPUT RESOLUTION FOR DVI AND VGA INPUT	#SET_OUTPUT_RES PARAMn PARAMn = 1 - 9 1 - 1360x768 60 Hz 2 - 1024x768 60 Hz 3 - 1280x720 50 Hz 4 - 1280x720 60 Hz 5 - 1280x800 60 Hz 6 - 1600x1200 60 Hz 7 - 1920x1080 50 Hz 8 - 1920x1080 60 Hz 9 - 1920x1200 60 Hz
#CET_OUTPUT_RES	CET THE OUTPUT RESOLUTION STATUS (VGA INPUT ONLY)	#CET_OUTPUT_RES
#SET_INPUT_HDCP	SET HDMI INPUT HDCP OPERATING MODE	#SET_INPUT_HDCP PARAMn PARAMn = 1-2 1 - ACTIVE (HDCP PASS-THROUGH) 2 - ON (ALWAYS ENCRYPT WITH HDCP 1.4)
#CET_INPUT_HDCP	CET HDMI INPUT HDCP OPERATING MODE	#CET_INPUT_HDCP
#SET_PICTURE_MODE	SET PICTURE MODE	#SET_PICTURE_MODE PARAMn PARAMn = 1 - 4 1 - DYNAMIC 2 - STANDARD 3 - VIVID 4 - USER
#CET_PICTURE_MODE	CET PICTURE MODE	#CET_PICTURE_MODE
#SET_CONTRAST	SET CONTRAST ADJUSTMENT (APPLICABLE ONLY WHEN PICTURE MODE IS SET TO USER)	#SET_CONTRAST PARAMn PARAMn = 0 - 100 0 - 100 - CONTRAST VALUE
#CET_CONTRAST	CET CONTRAST ADJUSTMENT VALUE	#CET_CONTRAST
#SET_BRIGHTNESS	SET BRIGHTNESS ADJUSTMENT (APPLICABLE ONLY WHEN PICTURE MODE IS SET TO USER)	#SET_BRIGHTNESS PARAMn PARAMn = 0 - 100 0 - 100 - BRIGHTNESS VALUE
#CET_BRIGHTNESS	CET BRIGHTNESS ADJUSTMENT VALUE	#CET_BRIGHTNESS
#SET_SATURATION	SET SATURATION ADJUSTMENT (APPLICABLE ONLY WHEN PICTURE MODE IS SET TO USER)	#SET_SATURATION PARAMn PARAMn = 0 - 100 0 - 100 - SATURATION VALUE
#CET_SATURATION	CET SATURATION ADJUSTMENT VALUE	#CET_SATURATION
#SET_SHARPNESS	SET SHARPNESS ADJUSTMENT (APPLICABLE ONLY WHEN PICTURE MODE IS SET TO USER)	#SET_SHARPNESS PARAMn PARAMn = 0 - 100
#CET_SHARPNESS	CET SHARPNESS ADJUSTMENT VALUE	#CET_SHARPNESS
#AUTO_SYNC	INITIATE VGA AUTO-SYNC FEATURE	#AUTO_SYNC
#SET_AUTO_SYNC	ENABLE/DISABLE VGA AUTO-SYNC FEATURE	#SET_AUTO_SYNC PARAMn PARAMn = 0 - 1 0 - DISABLE 1 - ENABLE
#CET_AUTO_SYNC	CET VGA AUTO-SYNC ADJUSTMENT VALUE	#CET_AUTO_SYNC
#SET_PHASE	SET VGA PHASE ADJUSTMENT	#SET_PHASE PARAMn PARAMn = 0 - 100, ..., + 0 - 100 - PHASE VALUE - - DECREASE PHASE BY ONE STEP + - INCREASE PHASE BY ONE STEP
#CET_PHASE	CET VGA PHASE ADJUSTMENT VALUE	#CET_PHASE
#SET_CLOCK	SET VGA CLOCK ADJUSTMENT	#SET_CLOCK PARAMn PARAMn = 0 - 100, ..., + 0 - 100 - CLOCK VALUE - - DECREASE CLOCK BY ONE STEP + - INCREASE CLOCK BY ONE STEP
#CET_CLOCK	CET VGA CLOCK ADJUSTMENT VALUE	#CET_CLOCK
#SET_COLOR_TEMP	SET COLOR TEMPERATURE ADJUSTMENT	#SET_COLOR_TEMP PARAMn PARAMn = 1 - 4 1 - WARM 2 - MEDIUM 3 - COOL 4 - USER

Command Code	Description	Syntax
#CET_COLOR_TEMP	SET COLOR TEMPERATURE ADJUSTMENT VALUE	#CET_COLOR_TEMP
#SET_COLOR_BALANCE	SET COLOR BALANCE ADJUSTMENT (APPLICABLE ONLY WHEN COLOR TEMPERATURE IS SET TO USER)	#SET_COLOR_BALANCE PARAM: PARAM2 PARAM = R, C, B R- RED C- GREEN B- BLUE PARAM2 = 0 -100
#CET_COLOR_BALANCE	GET COLOR BALANCE ADJUSTMENT VALUE(S)	#CET_COLOR_BALANCE PARAM PARAM = 0, R, C, B 0- ALL (VALUE ORDER IS RED GREEN BLUE) R- RED C- GREEN B- BLUE
#SET_ASPECT	SET ASPECT RATIO ADJUSTMENT	#SET_ASPECT PARAM: PARAM = 1 - 3 1-16:9 2- 4:3 3-AUTO
#CET_ASPECT	GET ASPECT RATIO ADJUSTMENT VALUE	#CET_ASPECT
#SET_POLARITY	SET POLARITY	#SET_POLARITY PARAM: PARAM2 PARAM = H - V H- HORIZONTAL POLARITY V- VERTICAL POLARITY PARAM2 = -, + - NEGATIVE + POSITIVE
#CET_POLARITY	GET POLARITY VALUE	#CET_POLARITY PARAM: PARAM = 0, H, V 0- ALL (VALUE ORDER IS HORIZONTAL NEGATIVE) H- HORIZONTAL POLARITY V- VERTICAL POLARITY
#SET_IMAGE_ADJ	SET VGA IMAGE ADJUSTMENT (AUTO-SYNC MUST BE SET TO DISABLED FOR THIS FEATURE TO FUNCTION)	#SET_IMAGE_ADJ PARAM: PARAM2 PARAM = D, L, R D- SHIFT IMAGE DOWN L- SHIFT IMAGE LEFT R- SHIFT IMAGE RIGHT PARAM2 = 0 - 30 0-30- ADJUSTMENT VALUE IN PIXELS (SEE BELOW FOR DIRECTIONAL LIMITS) PARAM2 LIMITS L- 0- 30 R- 0- 30 D- 0- 4
#CET_IMAGE_ADJ	GET VGA IMAGE ADJUSTMENT VALUE(S) (AUTO-SYNC MUST BE SET TO DISABLED FOR THIS FEATURE TO FUNCTION)	#CET_IMAGE_ADJ PARAM: PARAM = 0, D, L, R 0- ALL (VALUE ORDER IS DOWN/LEFT RIGHT) D- DOWN L- LEFT R- RIGHT
#SET_IMAGE_STRETCH	SET VGA IMAGE STRETCH (AUTO-SYNC MUST BE SET TO DISABLED FOR THIS FEATURE TO FUNCTION)	#SET_IMAGE_STRETCH PARAM: PARAM2 PARAM3 PARAM = W, H W- WIDTH H- HEIGHT PARAM2 = -, + - DECREASE (TOP LEFT CORNER OF IMAGE IS ANCHORED) + INCREASE (TOP LEFT CORNER OF IMAGE IS ANCHORED) PARAM3 = 0 - 30 0-30- ADJUSTMENT VALUE IN PIXELS (SEE BELOW FOR WIDTH AND HEIGHT LIMITS) PARAM3 LIMITS W INCREASE (+) 0- 20 W INCREASE (-) 0- 30 H INCREASE (+) 0- 4 H INCREASE (-) -NA
#CET_IMAGE_STRETCH	GET VGA IMAGE STRETCH VALUE(S) (AUTO-SYNC MUST BE SET TO DISABLED FOR THIS FEATURE TO FUNCTION)	#CET_IMAGE_STRETCH PARAM: PARAM = 0, W, H 0- ALL (VALUE ORDER IS WIDTH HEIGHT) W- WIDTH H- HEIGHT

Controlling the Display from the Source Location

1. Using a DB-9 cable, connect the 4x1 Switcher's **RS-232** port to a computer with a Serial (RS-232) port. You will need to use a USB-to-RS-232 adaptor if your PC does not have a Serial port. Establish Serial (RS-232) communications between the computer and the 4x1 Switcher.
2. Make sure the unit is IR pass-thru mode by sending the RS-232 command **#SET_IR_MODE 1** to the unit. Please see the RS-232 commands section ([Page 29](#)) for details on how to configure the Switcher.
3. Connect the included EXT-RMT-EXTIRN IR Extender to the **IR In/Ext** port on the 4x1 Switcher. If using an automation system, connect the 3.5mm mini-stereo connector from the **IR In/Ext** port on the 4x1 Switcher unit to the IR Output of the automation system. IR signals will be transmitted over the Link cable.
4. Connect an EXT-IREMIT IR Emitter (sold separately) from the **IR Out** port on the Receiver unit to the IR sensor on the display.

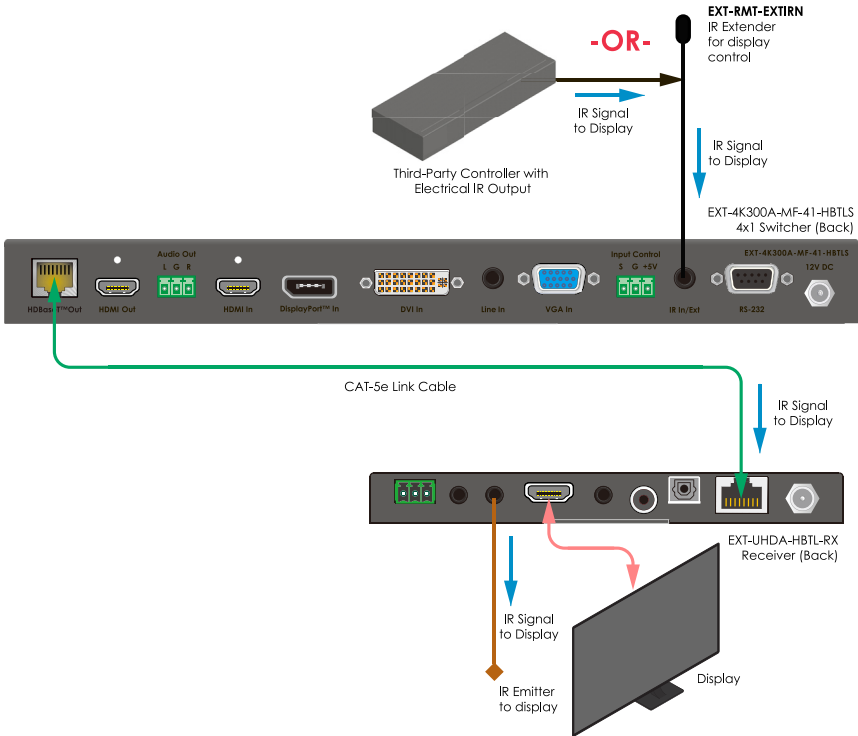

Controlling the 4x1 Switcher Locally

- Using a DB-9 cable, connect the 4x1 Switcher's **RS-232** port to a computer with a Serial (RS-232) port. You will need to use a USB-to-RS-232 adaptor if your PC does not have a Serial port. Establish Serial (RS-232) communications between the computer and the 4x1 Switcher.
- Make sure the unit is IR "Unit Control" mode by sending the RS-232 command **#SET_IR_MODE 2** to the unit. Please see the RS-232 commands section ([Page 29](#)) for details on how to configure the Switcher.
- Connect the included EXT-RMT-EXTIRN IR Extender to the **IR In/Ext** port on the 4x1 Switcher. If using an automation system, connect the 3.5mm mini-stereo connector from the **IR In/Ext** port on the 4x1 Switcher unit to the IR Output of the automation system. All IR commands sent to the **IR In/Ext** port of the unit will now be executed by the 4x1 Switcher. They will not be extended to the Receiver unit.
- If using the EXT-RMT-EXTIRN, make sure that it is placed within the line of sight from the RMT-MF-41A handheld remote that will be used to control the Switcher.

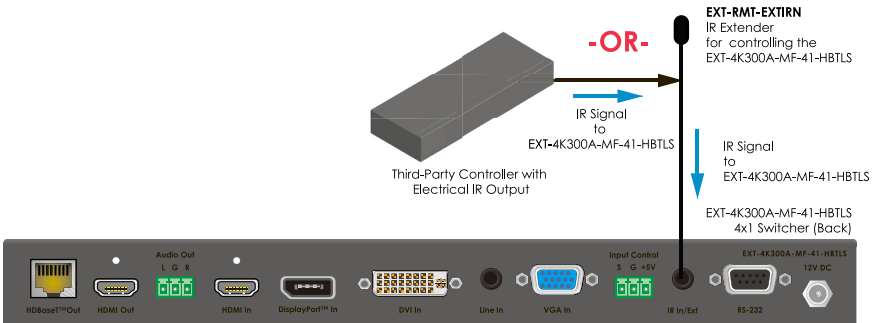

Firmware Update

1. Over time, the 4x1 Switcher may require a firmware update to add functionality or fix issues.
2. To perform a firmware update, a Windows PC that is running the Gefen Syner-G™ software needs to be connected to the **RS-232** port of the 4x1 Switcher. Use direct RS-232 connection if your PC has a serial port. If not, use a USB-to-RS-232 adaptor.
3. To update the 4x1 Switcher, the Gefen Syner-G™ software will send the necessary commands to place the product in firmware update mode. The firmware will be loaded into the 4x1 Switcher from a USB thumb drive, connected to the Micro-USB **Firmware** port on the unit's front panel via a USB-Micro-B-male-to-USB-Type-A-female cable or adaptor (available from major electronics stores).
4. Follow on-screen instructions in Gefen Syner-G™ to perform the firmware update.
5. Once a unit has successfully been updated, cycle the power by removing power from the Sender unit, wait for the Power LED to deactivate, and then reconnect the power supply.

EXT-4K300A-MF-41-HBTLS

Supported Formats	
HDMI & DisplayPort™ Inputs Maximum Video Resolution/Timing	<ul style="list-style-type: none"> 4K Cinema - DCI (4096 x 2160 to 60Hz, 4:2:0) 4K Ultra HD (3840 x 2160 to 60Hz, 4:2:0)
DVI & VGA Inputs Maximum Video Resolution/Timing	<ul style="list-style-type: none"> WUXGA (1920x1200 to 60 Hz 4:4:4)
HDBaseT™ Extension Maximum Video Resolution/Timing	<ul style="list-style-type: none"> 4K Cinema - DCI (4096 x 2160 to 60Hz, 4:2:0) 4K Ultra HD (3840 x 2160 to 60Hz, 4:2:0)
Audio (HDMI Pass-Thru)	<ul style="list-style-type: none"> Up to 8 channels of HBR, Bitstream, & LPCM
HDCP	<ul style="list-style-type: none"> HDMI & DP (2.2 and 1.4), DVI (1.4)
Connectors & Indicators	
Video Input Connectors	<ul style="list-style-type: none"> 1 x HDMI Type A, 19-pin, female 1x DisplayPort™, 20-pin, female 1x DVI, 29-pin, female, digital and analog 1 x VGA HD-15, female
Video Output Connectors	<ul style="list-style-type: none"> 1 x HDMI Type A, 19-pin, female 1x HDBaseT™, RJ-45, shielded, female
L/R Analog Line Input Connector	<ul style="list-style-type: none"> 1 x 3.5mm mini-stereo jack
L/R Analog Line Output Connector	<ul style="list-style-type: none"> 1 x 3-pin Phoenix
Firmware Update Connector	<ul style="list-style-type: none"> 1 x USB Micro-B, female
RS-232 Connector	<ul style="list-style-type: none"> 1 x DB-9, female
IR Extender Type	<ul style="list-style-type: none"> EXT-RMT-EXTIRN
IR In/Ext Connector	<ul style="list-style-type: none"> 1 x 3.5mm mini-stereo, female
Input Control Connector	<ul style="list-style-type: none"> 1 x 3-pin Phoenix
Power Connector	<ul style="list-style-type: none"> 1 x 12V DC, locking, 5.5mm barrel/2.1mm pin
Auto-Manual Switch	<ul style="list-style-type: none"> 1 x tact-type
POH On/Off Switch	<ul style="list-style-type: none"> 1 x slide-type
Power Indicator	<ul style="list-style-type: none"> 1 x LED, blue
Link Indicator	<ul style="list-style-type: none"> 1 x LED, green
HDMI, DP, DVI, VGA Indicators	<ul style="list-style-type: none"> 4 x LED, green
Auto (Switching) Indicator	<ul style="list-style-type: none"> 1 x LED, green
Operational	
TMDS Clock/Video Bandwidth	<ul style="list-style-type: none"> 340 MHz/10.2 Gbps
Power Consumption	<ul style="list-style-type: none"> Not powering a Receiver: 10W maximum Powering a Receiver: 22W maximum

Physical	
Operating Temperature	· +32 to +122 °F (0 to +50 °C)
Operating Humidity	· 5% to 90% RH, non-condensing
Storage Temperature	· -4 to +185 °F (-20 to +85 °C)
Storage Humidity (RH)	· 0% to 95% RH, non-condensing
MTBF	· 50000 hours
Dimensions (W x H x D, not including connectors)	Not including mounting brackets: · 12" x 1.2" x 4" (305mm x 30mm x 100mm) Including mounting brackets: · 13.1" x 1.2" x 4" (332mm x 30mm x 100mm)
Net Weight	· 1.3 lbs. (0.6 kg)

EXT-UHDA-HBTL-RX

Supported Formats	
Maximum Video Output Resolution/Timing	Overall Capability: <ul style="list-style-type: none"> 4K Cinema - DCI (4096 x 2160 to 60Hz, 4:2:0) 4K Ultra HD (3840 x 2160 to 60Hz, 4:2:0) When used with EXT-UHDV-HBTL-TX: <ul style="list-style-type: none"> 4K Ultra HD (3840 x 2160 at 30Hz, 4:4:4)
Audio (HDMI Pass-Thru)	<ul style="list-style-type: none"> Up to 8 channels of HBR, Bitstream, & LPCM
Audio (De-Embedded)	<ul style="list-style-type: none"> Up to 6 channels of Bitstream, or 2 channels of LPCM
HDCP	<ul style="list-style-type: none"> 2.2 and 1.4
Connectors & Indicators	
Video Output Connector	<ul style="list-style-type: none"> 1 x HDMI Type A 19-pin, female
De-Embedded Audio Output Ports	<ul style="list-style-type: none"> L/R Analog: 1 x 3.5mm mini-stereo jack Coaxial Digital: 1 x RCA, female Optical Digital: 1 x TosLINK®
HDBaseT™ Link Connector	<ul style="list-style-type: none"> 1 x RJ-45, shielded
RS-232 Connector	<ul style="list-style-type: none"> 1 x 3-pin Phoenix
Firmware Update Connector	<ul style="list-style-type: none"> 1 x USB Micro-B, female
IR Extender Type	<ul style="list-style-type: none"> EXT-RMT-EXTIRN
IR In/Ext Connector	<ul style="list-style-type: none"> 1 x 3.5mm mini-stereo, female
IR Out Connector	<ul style="list-style-type: none"> 1 x 3.5mm mini-stereo, female
Power Connector	<ul style="list-style-type: none"> 1 x 12V DC, locking, 5.5mm barrel/2.1mm pin
RS-232/Program Switch	<ul style="list-style-type: none"> 1 x 3-position, slide-type
Power Indicator	<ul style="list-style-type: none"> 1 x LED, blue
Link Indicator	<ul style="list-style-type: none"> 1 x LED, green
HDCP Indicator	<ul style="list-style-type: none"> 1 x LED, green
Operational	
TMDS Clock	<ul style="list-style-type: none"> 340 MHz
Video Bandwidth	<ul style="list-style-type: none"> 10.2 Gbps
Power Consumption	<ul style="list-style-type: none"> Not powering a Sender: 9W maximum Powering a Sender: 22W maximum
Operating Temperature	<ul style="list-style-type: none"> +32 to +122 °F (0 to +50 °C)
Operating Humidity	<ul style="list-style-type: none"> 5% to 90% RH, non-condensing
Storage Temperature	<ul style="list-style-type: none"> -4 to +185 °F (-20 to +85 °C)
Storage Humidity (RH)	<ul style="list-style-type: none"> 0% to 95% RH, non-condensing
MTBF	<ul style="list-style-type: none"> 50000 hours

Physical	
Dimensions (W x H x D, not including connectors)	Not including mounting brackets: · 6" x 0.65" x 4" (152mm x 17 x 100mm) Including mounting brackets: · 7" x 0.65" x 4" (178mm x 17 x 100mm)
Net Weight	· 0.6 lbs. (0.27 kg)

* Features and specifications are subject to change without notice.
All trademarks and registered trademarks are properties of their respective owners.
Copyright© 2018 Nortek Security & Control, LLC



5919 Sea Otter Place, Suite 100 , Carlsbad, CA 92010, USA
1800 S McDowell Blvd, Petaluma, CA 94954, USA
1-707-283-5900 1-800-472-5555

Copyright© 2018 Nortek Security & Control, LLC

Part Number: MAN-EXT-4K300A-MF-41-HBTL5 Version A1