

## One key controller

### Instruction for installation

Read and understand this manual, exactly install the one key controller

This manual apply to the installation of one key controller, coordinate wired controller, centralized controller

Memo: this data must be used when proceed below installation items. please keep in good condition.  
(carrying and installing) → (wiring) → (running in) → (user)

### Begin

The product is controller of internal general air-conditioning

Cannot put the controller on below place. the product must be far away from flammable gas and liquid, because it will lead to fire hazard and deformation, corrosion or damage.

- the place where will be splashing of oil (included machine oil) and the place where is vaporous vapory
- the place where will be much Sulfide gas, such as hot spring

Cannot put the controller on below place. the product will be corrosion

- the place where is high salinity, such as seaboard
- acid gas environment
- when use medical apparatus and instruments which will emit electromagnetic wave, in order to prevent the electromagnetic interference lead to the wrong operation. Please do not install the product in the same direction with the electromagnetic wave device.
  - in order to avoid the electromagnetic interference, please install the product 3m away from the electromagnetic device and broadcasting equipment.

### Safety Summary

- Read the Safety Summary before installation and use.
- the matters need attention divide into: [⚠warning], [⚠attention]. [⚠warning] record the items about serious injury or death which cause by wrong installation. [⚠attention] record the possible serious result according to the different status. both of this two points are involve safety, Please comply with them.
- after installation, proceed the “running in”, explain to the users about the method of application and maintenance method also tell user to keep the “instruction for installation” after confirm the operation is in good condition.

### 【Meaning of symbol】

⚠ Warning: it means that wrong operation will be lead to serious injury or death

ⓘ : Mandatory items. It means that ,indicate the not specified users

⊘ : Prohibited items

### Warning of installation

 warning	● please install serious according to the manual or will lead to electric shock, fire hazard or controller fall down	ⓘ
	● when install the product, there Should consider the weight capacity, when the strength not enough or install insufficiency, it will easy lead to the controller falling down and damage the product	ⓘ
	● Please do not place the product to the position of flammable gas and liquid, it will possible cause the fire hazard .	⊘

### Electrical construction

 warning	● Please entrust the qualified installer and the qualified electrical installer for the installation, or it will have a risk of electric shock.	ⓘ
	● When proceed the electrical installation, please refer to relevant national standard and follow relevant technical standard of electrical equipment . Must use separate power distribution, if power capacity is not enough or construction not good will lead to electric shock or fire hazard.	ⓘ

	● must cut all the power for the indoor unit before wiring. Because under the status of power on, and proceed the wiring will cause the PCB of indoor unit and controller breaking down	①
	● electric wiring ,spot check which need to open the air-conditioning elektrischer Kasten or controller, please cut all the power.	①

indicate confirmation items, after confirmation then mark by☑

## 1. Installation work

### 【Designation of installation place】

□1) the installation of one key controller should be base on the easy operation, and get the acceptance from customers. please do not install the product to below place;

- the place where child can reach
- the air outlet of air-conditioning
- the place where have steam with oil
- the place where with high humidity

□2) in order to prevent the electromagnetic interference lead to the wrong operation. Please do not install the product in the same direction with the electromagnetic wave device.

○do not let the electromagnetic wave device face to the Electrical Cabinet, cable, remote control and other controller directly.





○in order to avoid the electromagnetic interference, please place the controller 3m away from the electromagnetic wave device

○please place the controller into iron box, and put the cable into iron pipe

○if there is electromagnetic interference, please install the filter.

### 【Before installation】

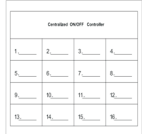
□1) ensure the components in the package before installation.

Name	One key controller	Screw	Label	Instruction for Installation	magnet ring
shape		 M4×23mm			
quantity	1	2	1	1	1
use	run/stop	Use for nounenon installation	Use for marking	Spot check instruction for installation	interferenc e prevention

### 【Main point for installation】

 Warning	● Please install or operate one key controller according to this manual or it will possible lead to the product falling down and damage.	①
--	--	---

□1) one key controller must be used after fixation.

□2) turn on two locations show as below two depressions (there are two PCB, please do not let them contact) .

□3) open the accessory, install by self-contained tool.

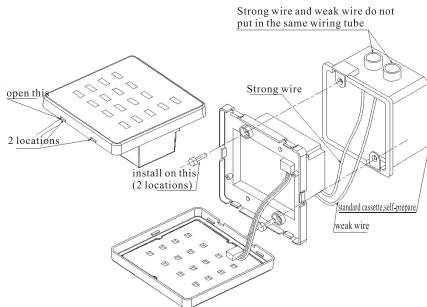

## 2. Main points of wiring connection

 Wa rn in g	<ul style="list-style-type: none"> <li>● cut the power before set the dial switch of one key controller or it will lead to the electric shock</li> </ul>	①
	<ul style="list-style-type: none"> <li>● the connection of wiring should be firm. If connect loose, the temperature of wire will increase, this will lead to fire hazard or electric shock.</li> </ul>	①
	<ul style="list-style-type: none"> <li>● outer connected wiring should be firm, if the firm reject, the temperature will increase, this will lead to fire hazard.</li> </ul>	①
	<ul style="list-style-type: none"> <li>● cut the power before proceed the wiring operation or it will cause the electric shock.</li> </ul>	①

Memo	<ul style="list-style-type: none"> <li>● Avoid the line of communication and the 220V power line Routing Neck and neck. Or it will have interference and lead to wrong operation.</li> </ul>	①
------	--	---

### □1) Methods of wiring

At most 8 sets of one key controllers connection to the same communication (wiring control) Line of communication of one key controller, connected line of communication of outdoor unit and connected line of communication of indoor unit (DC5V) are “2 core” cable(0.75~1.25mm) (type: VCTF, VCT, CVV, MVVS, CVVS, VVR, VVF) or “2 core” twisted-pair (type: KPEV, KPEV-S). Besides, overall length of wiring is under 1000m.

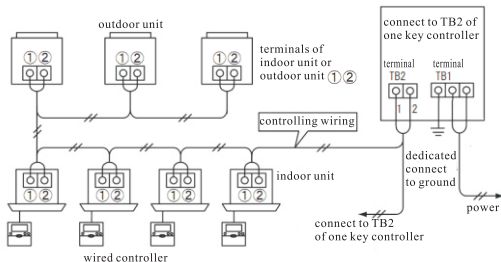

□2) The setting of dial switch

• Set the dial switch according to below form. When one key controllers(at most 8 sets) connect to several machines in same communication protocol, it need to set the address (default: OFF)

●The setting of dial switch

	NO.	content	DSW set		Memo
			OFF	ON	
DSW1	1	Use to address setting	Refer to below setting		When one key controllers(at most 8 sets) connect to several machines in communication, each one key controllers need to set the address.※1
	2				
	3				
	4	models	other	unit	—

●Address setting of DSW1

Address	0	1	2	3	4	5	6	7
DSW1 setting	ON OFF ON OFF ON OFF ON OFF	ON OFF ON OFF ON OFF ON OFF	ON OFF ON OFF ON OFF ON OFF	ON OFF ON OFF ON OFF ON OFF	ON OFF ON OFF ON OFF ON OFF	ON OFF ON OFF ON OFF ON OFF	ON OFF ON OFF ON OFF ON OFF	ON OFF ON OFF ON OFF ON OFF

※1:when connect with several set of one key controllers in the same time, DSW1 cannot set repetition, or it will be abnormal .

●attentions when use 220V alternating current

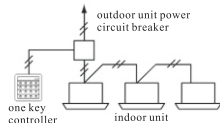

● AC220, as left picture show, separate from Electrical Cabinet then connect ( the wiring between indoor unit ,please refer to manual)

Attention

- If wrong connection, then the one key controller will break down.
- if the one key controller connect under the status of power on, the one key controller will possible break down, therefore, please cut the power of air-conditioning and controller.
- please do not make the line of communication, cable and other line of communication routing Neck and neck, if you must to do this, the distance between the wiring must be > 30cm, or use iron pipe ,and need to connect to ground.
- if mistake to connect the cable to the terminal strip, the fuse of PCB will fusing. after correct connection, set the DSW1-2 dial switch of PCB to ON .
- TBl ground connection terminal is a Surge absorber pins. It need to connect the ground connection terminal wiring if proceed the insulating property test and pressure-tight test .

### 3. Group register

● Attention of group register

Attention:

- If use the one key controller to control the indoor unit, the indoor unit need to connect to wired control or wireless receiver.
- In Group register treating processes, the one key controller cannot be operated.
- one wired controller connect to indoor unit with different systems is not allowed.
- must connect to Secondary or above communication protocol indoor unit.

The ways of one key controller register as below:

□1) Group Setting Procedure

- (1) Nomenclature of one key controller have not got the function of group register, when group register self-motion grouping via indoor unit address setting.
- (2) Indoor units of same wired controller define to a ground, as below figures show, each units is a ground.

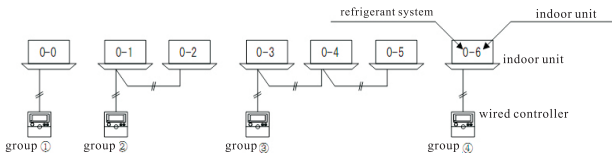

- (3) Up to 8 one key controllers can connect to the same communication (wiring control). When single one key controller connect to several machines, the DSW1 of one key controller will set as address.
- (4) single one key controller register as per the address of indoor unit, below condition mean finish register:
  - 16 groups finish register
  - no indoor unit in the same refrigerant system.
  - the address is discontinuity in the same refrigerant system, and there is follow-up discontinuity in the same refrigerant system

In the same communication protocol connect several one key controllers, one key controller register from machine 0, after ground 0 finish register, then the ground 1, ground 2, ground 3....

sample of group login

address of indoor unit \ address of refrigerant system	0	1	2	3	4	5	6	7	8	9	10	11	12	13	14	15	16	17	18	19	...	
0	①	②	③	④	⑤	⑥	⑦	⑧														
1								⑨	⑩	⑪	⑫	⑬	⑭	⑮	⑯	⑰	⑱	⑲				
2			③	④	⑤	⑥	⑦	⑧	⑨	⑩												
3																						
4	①	②	③	④	⑤	⑥	⑦	⑧														
5	⑨	⑩	⑪	⑫	⑬	⑭	⑮	⑯	⑰	⑱												
6	⑦	⑧																				
⋮																						

①~⑱ mean one key controller login locations

□2) Example of ground setting

- (1) single one key controller connection

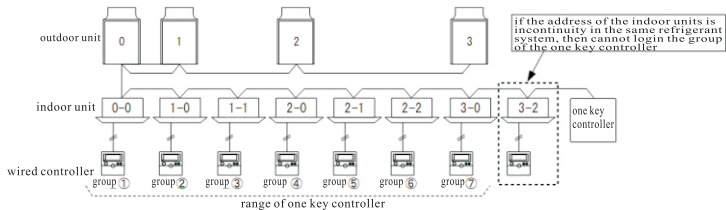

(2) several one key controllers connection

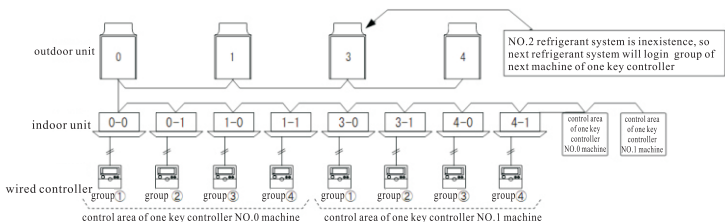

(3) Different connection of one key controllers in same refrigerant system

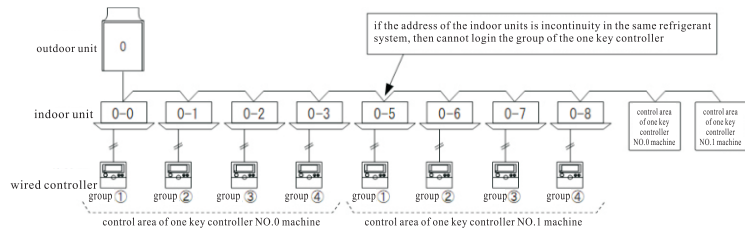

(4) Some of the indoor units do not use the one key controller in system, but can register via one key controller, cut the address of refrigerant system of indoor controller or address of indoor controller, Make it independent, in the meantime, corresponding one key controllers of this part of indoor unit have not been connected, so that this part of indoor unit will not be controlled by any one key controller in system

《refrigerant system address break off setting》

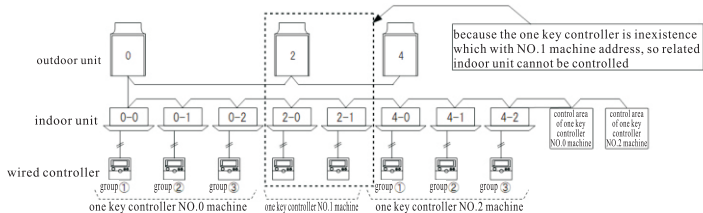

《indoor unit address setting break off》

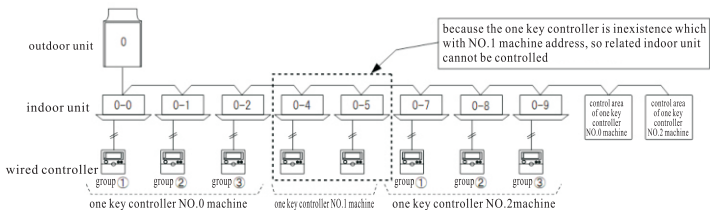

#### 4. External input function

Do not has this function as yet.

#### 5. Main points of spot check

□(preparation) • before use the power of one key controller, air-conditioning must be proceeded the test run.

- after air-conditioning test run, operate the wired controller and set the temperature by hand .

(if cannot set the temperature or the wired controller cannot display the temperature, then the one key controller cannot operate, you must solve the trouble)

□1) the register of group proceed as below steps.

- (1) after confirm the action of air-conditioning, then make the air-conditioning under the status of pro w on.
- (2) connect the one key controller power
- (3) the LED on one key controller sequence to light, below figure is the process of register. <process of LED operate>

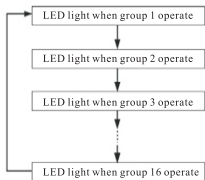

When confirm the connection ,the above LED will light by cycle.

After 16 groups in Address of refrigerating system finish register, operate LED reset.

※if all LED blink (0.25s on/0.25s off) , it means that the issue of indoor unit has not connect to wired controller has been detected, please stop the register of one key controller, check the system again, after debug all the breakdowns, register again.

□2) confirmation of group.

- (1) please confirm the register of group proceed as above sequence
- (2) please confirm the setting of group and register are consistent.
- (3) if there is something wrong about setting of group or the connection, please cut the power and check again, refer to below content:
  - ①forget to connect the power of indoor unit or poor connection
  - ②wrong setting about indoor unit system no. or address
  - ③wrong setting about one key controller address
- (4) to connect the indoor unit, outdoor unit, one key controller correctly, power and register again

#### 【operation of one key controller reset】

- ①when all groups stop, press [15] and [16] at the same time over 3s, group [15] and [16] operate and LED light.
- ②press button [15] 和 [16] at the same time again, LED of group [6] blink, press button [2] , LED of group [6] light always.
- ③after operation of one key controller reset finish, all the LED turn off, then group register again.





