

SPECIFICATIONS

Loudspeaker Type:	3-way horn loaded triaxial, weather-resistant
Operating Range:	70 Hz to 16 kHz 80 Hz to 10 kHz (± 6 dB)
Max Input Ratings:	400W continuous, 1000W program 40 volts RMS, 89 volts momentary peak
Recommended Power Amplifier:	830W to 1200W @ 4 ohms
Sensitivity (1W/1m):	107 dB SPL (80 Hz to 16 kHz 1/3 octave bands) 109 dB SPL (250 Hz to 4 kHz speech range)
Maximum Output:	133 dB SPL / 140 dB SPL (peak)
Nominal Impedance:	4 ohms
Minimum Impedance:	2.7 ohms @ 660 Hz
Nominal -6dB Beamwidth:	50° H (+36° / -15°, 1.25 kHz to 10 kHz) 20° V (+13° / -5°, 1.25 kHz to 10 kHz) 100° H x 100° V (400 Hz)
Axial Q / DI:	37.9 / 15.8, 1.25 kHz to 10 kHz
Crossover Frequency:	600 Hz / 3.5 kHz
Recommended Signal Processing:	70 Hz high pass filter
Drivers:	LF 2 x 12" weather-treated, Ferrofluid-cooled MF 2 x M200 2" exit, non-metallic diaphragm, Ferrofluid-cooled HF 1 x 1" exit, titanium diaphragm
Driver Protection:	DYNA-TECH protection circuitry
Input Connection:	12 foot (4 m) SJOW #16 gauge
Controls:	None
Enclosure:	Hand-laminated fiberglass, light grey gelcoat
Mounting/Rigging Provisions:	(5) 1/2-13 rigging points
Grille:	3-layer WeatherStop™, light grey (Zinc-rich epoxy dual-layer powder coated perforated steel grille, foam, woven poly mesh)
Environmental Performance:	IEC529 IP55W rating with a minimum 5-degree downward aiming angle
Required Accessories:	70 Hz high pass filter
Supplied Accessories:	Weather-resistant mounting yoke, light grey
Optional Accessories:	TRC400 400-watt 70/100/140-volt transformer
Dimensions—Height:	24.75 inches (629 mm)
Width:	24.75 inches (629 mm)
Depth:	30.75 inches (781 mm)
Weight:	102.5 lbs (46.5 kg)
Shipping Weight:	136 lbs (61.7 kg)

NOTES:

- Sensitivity: Free field pink noise measurement at 40 ft (12.2 m) at 25% power; extrapolated to 1 meter and an input of 2 volts RMS.
- Watts: All wattage figures are calculated using the rated nominal impedance.



APPLICATIONS

- Athletic fields (football, soccer, baseball, tennis)
- Small arenas, athletic field houses
- Theme and amusement parks
- Fairgrounds, rodeos, air shows
- Racing tracks, skating rinks, swimming pools
- Convention centers, factories, warehouses
- Cruise ships
- Portable sound systems
- Electronic carillons

FEATURES

- Weather resistant construction
- Weather-treated drivers and crossovers
- Corrosion-resistant zinc-rich epoxy dual-layer powder coated steel grille and yoke
- Application-specific coverage pattern
- High-efficiency horn loading
- High-fidelity, full-range reproduction of music and speech
- Included weather-resistant mounting yoke for easy mounting and aiming
- Five-year product warranty / Fifteen-year enclosure warranty

DESCRIPTION

The R2-52Z full-range loudspeaker system is engineered to provide quality, long throw full-range sound projection in a variety of outdoor and indoor applications. Its wide, smooth frequency response and high efficiency ensures high-fidelity music reproduction along with superb projection of clear, intelligible speech at very low distortion.

The R2-52Z is an all horn loaded triaxial design using precision waveguides manufactured by Community of hand-laminated fiberglass. The outer enclosure forms a double wall construction with the internal bass horn, providing a completely weather-sealed chamber for the LF drivers. The mid/high frequency horn assembly is mounted in the mouth of the bass horn. A high quality passive crossover with dynamic driver protection is included. The result is a loudspeaker system that is extremely strong, non-resonant, weather-resistant, and easy to install.

FREQUENCY RESPONSE

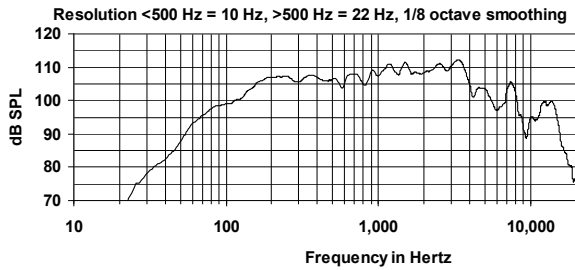

IMPEDANCE

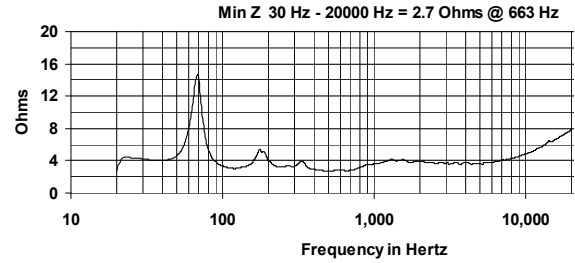

BEAMWIDTH

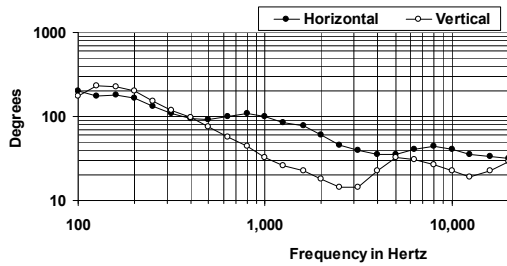

AXIAL Q

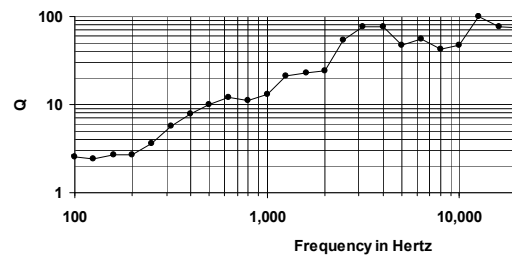

DIMENSIONS

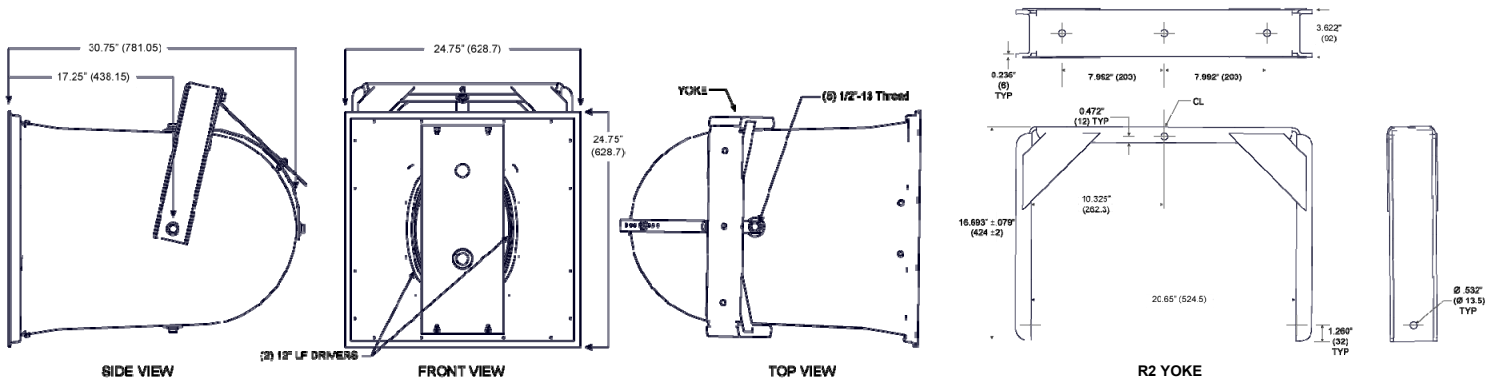

ARCHITECTURAL SPECIFICATIONS

The loudspeaker system shall be a horn-loaded, three-way, full-range tri-axial design with two 12" Ferrofluid-cooled woofers treated with moisture repellant on a bass horn and two 2" exit Ferrofluid-cooled midrange compression drivers with a non-metallic diaphragm and one 1" exit HF driver with a titanium diaphragm mounted on respective fiberglass horns built within the bass horn. Drivers shall be connected to an integral crossover with crossover frequencies of 600 Hz and 3.5 kHz and integral over-current protection circuitry using high positive current coefficient resistors. The input connection shall be one 16-2 12-foot (4m) SJOW Cable with stripped ends. The loudspeaker enclosure shall be an integral double-wall weather-sealed light grey fiberglass bell with a three-layer weather-resistant grille. The steel grille shall be powder coated with a proprietary zinc-rich epoxy dual-layer powder coating process in light grey to color match the enclosure. The system shall have an IEC529 IP rating of IP55W with a minimum 5-degree downward aiming angle. There shall be five 1/2 - 13 threaded mounting points. The system shall have an amplitude response of 80 Hz to 10 kHz (+/- 6 dB), input capability of 40V RMS, 107 dB sensitivity at one meter / 2V and 4 ohms nominal impedance. The nominal dispersion shall be 50°H x 20°V from 1250 Hz to 10 kHz. The loudspeaker shall be 24.75 in. (629 mm) H x 24.75 in. (629 mm) W x 30.75 in. (781 mm) D and weigh 102.5 lbs (46.5 kg).

Community strives to improve its products on a continual basis. Specifications are therefore subject to change without notice.