

# **Kramer Electronics, Ltd.**

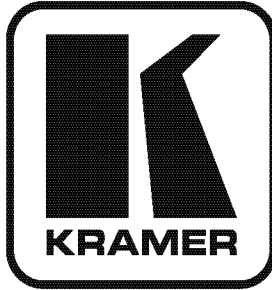

## **USER MANUAL**

### **Models:**

***TP-121EDID, XGA / Audio Line Transmitter***

***TP-123EDID, XGA / Audio / Data Line Transmitter***

***TP-125EDID, XGA / Audio / Data Line Transmitter***

***PT-110EDID, XGA Line Transmitter***

## Contents

<b>1</b>	<b>Introduction</b>	<b>1</b>
<b>2</b>	<b>Getting Started</b>	<b>1</b>
2.1	Quick Start	1
<b>3</b>	<b>Overview</b>	<b>3</b>
3.1	Shielded Twisted Pair (STP) / Unshielded Twisted Pair (UTP)	3
3.2	About the Power Connect Feature	3
3.3	Defining EDID	4
3.4	Recommendations for Achieving the Best Performance	4
<b>4</b>	<b>Your TP-121EDID XGA / Audio Line Transmitter</b>	<b>4</b>
4.1	Connecting the TP-121EDID XGA / Audio Line Transmitter	6
4.2	Technical Specifications	8
<b>5</b>	<b>Your TP-123EDID XGA / Audio / Data Line Transmitter</b>	<b>8</b>
5.1	Connecting the TP-123EDID XGA / Audio / Data Line Transmitter	9
5.2	Controlling via RS-232 (for example, using a PC)	12
5.3	Technical Specifications	12
<b>6</b>	<b>Your TP-125EDID XGA / Audio / Data Line Transmitter</b>	<b>13</b>
6.1	Connecting the TP-125EDID XGA / Audio / Data Line Transmitter	14
6.2	Transmitting via RS-232 (for example, using a PC)	16
6.3	Technical Specifications	17
<b>7</b>	<b>Your PT-110EDID XGA / Line Transmitter</b>	<b>17</b>
7.1	Connecting the PT-110EDID XGA / Line Transmitter	18
7.2	Technical Specifications	20
<b>8</b>	<b>Wiring the CAT 5 LINE IN / LINE OUT RJ-45 Connectors</b>	<b>21</b>
<b>9</b>	<b>Acquiring the EDID</b>	<b>21</b>

## Figures

Figure 1:	TP-121EDID XGA / Audio Line Transmitter	5
Figure 2:	Connecting the TP-121EDID XGA / Audio Line Transmitter	7
Figure 3:	TP-123EDID XGA / Audio / Data Line Transmitter	9
Figure 4:	Connecting the TP-123EDID XGA / Audio / Data Line Transmitter	11
Figure 5:	RS-232 PINOUT Connection	12
Figure 6:	TP-125EDID XGA / Audio / Data Line Transmitter	13
Figure 7:	Connecting the TP-125EDID XGA / Audio / Data Line Transmitter	16
Figure 8:	RS-232 PINOUT Connection	16
Figure 9:	PT-110EDID XGA Line Transmitter	18
Figure 10:	Connecting the PT-110EDID XGA / Line Transmitter	20
Figure 11:	CAT 5 PINOUT	21

## Tables

Table 1: TP-121EDID XGA / Audio Line Transmitter Features	5
Table 2: Technical Specifications of the TP-121EDID	8
Table 3: TP-123EDID XGA / Audio / Data Line Transmitter Features	9
Table 4: RS-232 PINOUT Connection	12
Table 5: Technical Specifications of the TP-123EDID	12
Table 6: TP-125EDID XGA / Audio / Data Line Transmitter Features	14
Table 7: RS-232 PINOUT Connection	16
Table 8: Technical Specifications of the TP-125EDID	17
Table 9: PT-110EDID XGA Line Transmitter Features	18
Table 10: Technical Specifications of the PT-110EDID	20
Table 11: CAT 5 PINOUT	21

## 1 Introduction

Welcome to Kramer Electronics! Since 1981, Kramer Electronics has been providing a world of unique, creative, and affordable solutions to the vast range of problems that confront the video, audio, presentation, and broadcasting professional on a daily basis. In recent years, we have redesigned and upgraded most of our line, making the best even better! Our 1,000-plus different models now appear in 11 groups<sup>1</sup> that are clearly defined by function.

Thank you for purchasing your Kramer TOOLS: **TP-121EDID**, XGA / Audio Line Transmitter, and/or **TP-123EDID**, XGA / Audio / Data Line Transmitter, and/or **TP-125EDID**, XGA / Audio / Data Line Transmitter, and/or Kramer Pico TOOLS™ **PT-110EDID**, XGA Line Transmitter, which are ideal for:

- Presentation and multimedia applications
- Long range graphics distribution for schools, hospitals, security, and stores

The package includes:

- One or more of the following: **TP-121EDID**, **TP-123EDID**, **TP-125EDID** or **PT-110EDID**
- Power adapter (12V DC)
- This user manual<sup>2</sup>

## 2 Getting Started

We recommend that you:

- Unpack the equipment carefully and save the original box and packaging materials for possible future shipment
- Review the contents of this user manual
- Use Kramer high-performance high-resolution cables<sup>3</sup>

### 2.1 Quick Start

This quick start chart summarizes the basic setup and operation steps.

---

1 GROUP 1: Distribution Amplifiers; GROUP 2: Switchers and Matrix Switchers; GROUP 3: Control Systems; GROUP 4: Format/Standards Converters; GROUP 5: Range Extenders and Repeaters; GROUP 6: Specialty AV Products; GROUP 7: Scan Converters and Sealers; GROUP 8: Cables and Connectors; GROUP 9: Room Connectivity; GROUP 10: Accessories and Rack Adapters; GROUP 11: Sierra Products

2 Download up-to-date Kramer user manuals from the Internet at <http://www.kramerelectronics.com>

3 The complete list of Kramer cables is on our Web site at <http://www.kramerelectronics.com>

## To connect your Kramer Transmitter

- 1 Connect the sources to the input connectors.
- 2 Connect the LINE OUTPUT RJ-45 connector on the transmitter to the LINE IN RJ-45 connector on the appropriate receiver (see section 8).
- 3 Connect the power to both the transmitter and the appropriate receiver (unless the Power Connect system applies).

### TP-121EDID (Section 4)

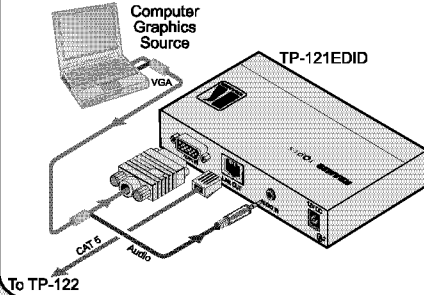

### TP-123EDID (Section 5)

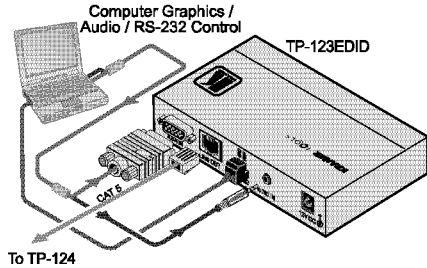

### TP-125EDID (Section 6)

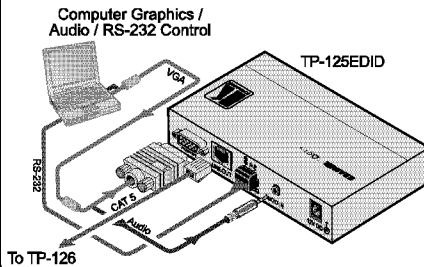

### PT-110EDID (Section 7)

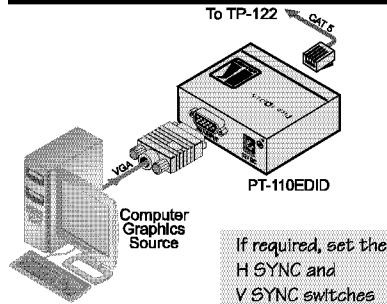

## To acquire the EDID (Section 9)

1. Connect the XGA INPUT 15-pin HD connector to the input XGA connector of the display, using a short cable.
2. Connect the display power.
3. On the Transmitter, connect the 12V DC power adapter to the power socket and connect the adapter to the mains electricity.
4. Press the EDID CAPTURE button.
5. Once the EDID STATUS blinks slowly several times, the EDID is captured.
6. Disconnect the display.

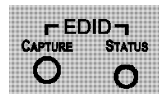

### 3 Overview

This user manual describes the following:

- **TP-121EDID** XGA / Audio Line Transmitter (see section 4)
- **TP-123EDID** XGA / Audio / Data Line Transmitter (see section 5)
- **TP-125EDID** XGA / Audio / Data Line Transmitter (see section 6)
- **PT-110EDID** XGA Line Transmitter (see section 7)

This section describes:

- Using shielded twisted pair (STP) / unshielded twisted pair (UTP), see section [3.1](#)
- The power connect feature, see section [3.2](#)
- Defining EDID, see section [3.3](#)
- Recommendations for achieving the best performance, see section [3.4](#)

#### 3.1 Shielded Twisted Pair (STP) / Unshielded Twisted Pair (UTP)

We recommend that you use shielded twisted pair (STP) cable. There are different levels of STP cable available, and we advise you to use the best quality STP cable that you can afford. Our non-skew-free cable, Kramer **BC-STP** is intended for analog signals where skewing is not an issue. For cases where there is skewing, our UTP skew-free cable, Kramer **BC-XTP**, may be used. Bear in mind, though, that we advise using STP cables where possible, since the compliance to electromagnetic interference was tested using those cables.

Although unshielded twisted pair (UTP) cable might be preferred for long range applications, the UTP cable should be installed far away from electric cables, motors and so on, which are prone to create electrical interference. However, since the use of UTP cable might cause inconformity to electromagnetic standards, Kramer does not commit to meeting the standard with UTP cable.

#### 3.2 About the Power Connect Feature

The Power Connect feature applies as long as the cable can carry power. The distance does not exceed 50m on standard CAT 5 cable, for longer distances, heavy gauge cable should be used<sup>1</sup>.

For a CAT 5 cable exceeding a distance of 50m, separate power supplies should be connected to the transmitter and to the receiver simultaneously.

---

<sup>1</sup> CAT 5 cable is still suitable for the video/audio transmission, but not for feeding the power at these distances

### 3.3 Defining EDID

The Extended Display Identification Data (EDID<sup>1</sup>) is a data-structure, provided by a display, to describe its capabilities to a graphics card (that is connected to the display's source). The EDID enables the graphic source to "know" what kind of monitor is connected to the output. The EDID includes the manufacturer's name, the product type, the timing data supported by the display, the display size, luminance data and (for digital displays only) the pixel mapping data.

### 3.4 Recommendations for Achieving the Best Performance

To achieve the best performance:

- Use only good quality connection cables<sup>2</sup> to avoid interference, deterioration in signal quality due to poor matching, and elevated noise levels (often associated with low quality cables).
- Avoid interference from neighboring electrical appliances that may adversely influence signal quality and position your Kramer transmitters away from moisture, excessive sunlight and dust



**Caution** – No operator-serviceable parts inside unit.

**Warning** – Use only the Kramer Electronics input power wall adapter that is provided with this unit<sup>3</sup>.

**Warning** – Disconnect power and unplug unit from wall before installing or removing device or servicing unit.

## 4 Your TP-121EDID XGA / Audio Line Transmitter

The **TP-121EDID** is an XGA / audio stereo line transmitter. It receives an XGA signal and an unbalanced stereo analog audio signal and transmits them over CAT 5 cable to a receiver<sup>4</sup>, converting the unbalanced stereo analog audio signal to digital audio (S/PDIF) stream before transmitting, thus preserving the quality of the audio signal.

When the **TP-121EDID** is connected to a display device and the EDID CAPTURE button is pressed, the **TP-121EDID** reads and stores the EDID

---

<sup>1</sup> Defined by a standard published by the Video Electronics Standards Association (VESA)

<sup>2</sup> Available from Kramer Electronics on our Web site at <http://www.kramerelectronics.com>

<sup>3</sup> For example: model number AD2512C, part number 2535-000251

<sup>4</sup> For example, the Kramer TP-122 XGA / Audio Line Receiver

(Extended Display Identification Data) from the display device. The display can be disconnected and later reconnected without rebooting the operating system.

In particular, the **TP-121EDID**:

- Has a transmission range of more than 300ft (more than 100m), and a 20kHz audio bandwidth with an S/N ratio that exceeds 80dB on the same transmission range
- Can power or be powered by the receiver over the same CAT 5 cable
- Is 12V DC fed

Figure 1 and Table 1 define the **TP-121EDID**:

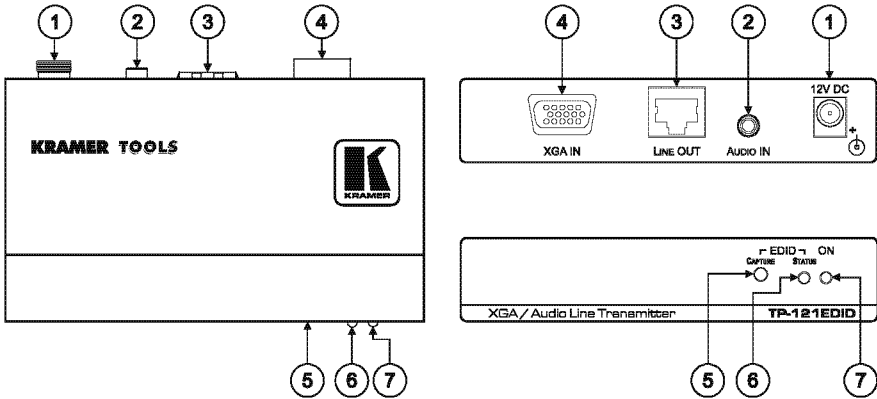

Figure 1: TP-121EDID XGA / Audio Line Transmitter

Table 1: TP-121EDID XGA / Audio Line Transmitter Features

#	Feature	Function
1	12V DC	+12V DC connector for powering the unit
2	AUDIO IN 3.5mm mini jack	Connects to the audio source
3	LINE OUT RJ-45 connector	Connects to <sup>1</sup> the LINE IN RJ-45 connector on a receiver
4	XGA IN 15-pin HD (F) connector	Connect to the XGA source
5	EDID <sup>2</sup> CAPTURE Button	Press to acquire the EDID information from the display
6	STATUS LED	Illuminates during normal operation; blinks when acquiring the EDID
7	ON LED	Illuminates when receiving power

<sup>1</sup> Using a CAT 5 cable with RJ-45 connectors at both ends (the PINOUT is defined in Table 11 and Figure 11)

<sup>2</sup> See section 2



## 4.1 Connecting the TP-121EDID XGA / Audio Line Transmitter

You can use the **TP-121EDID** together with the **TP-122 XGA / Audio Line Receiver**<sup>1</sup> to configure an XGA/Audio Line-to-Twisted Pair Transmitter and Receiver system.

Before connecting the transmitter and receiver system you can acquire the EDID from the display or set the system to the default EDID, see section 9.

To connect the **TP-121EDID XGA / Audio Line Transmitter** with the **TP-122 XGA / Audio Line Receiver**, as the example in [Figure 2](#) illustrates, do the following:

1. On the **TP-121EDID**, connect the XGA source (for example, a laptop's graphics card) to the XGA INPUT 15-pin HD (F) connector and an audio source to the AUDIO IN 3.5mm mini jack, for example, using a Kramer C-GMA/GMA cable (VGA 15-pin HD (M) +Audio jack to VGA 15-pin HD (M) +Audio jack)<sup>2</sup>. Alternatively, you can connect an XGA source to the XGA INPUT 15-pin HD (F) connector, and a separate audio source to the AUDIO IN 3.5mm mini jack.
2. On the **TP-122**, connect the XGA OUT 15-pin HD (F) connector to the XGA acceptor (for example, a display), and connect the AUDIO OUT S/PDIF RCA connector to the digital audio acceptor (for example, an AV Receiver), and the ANALOG 3.5mm mini jack to the analog audio acceptor (for example, a stereo audio recorder).
3. Connect the LINE OUTPUT RJ-45 connector on the **TP-121EDID** to the LINE IN RJ-45 connector on the **TP-122**, via CAT 5 cabling (with a range of more than 300ft (>100m)), see section 8.
4. Connect the 12V DC power adapter to the power socket and connect the adapter to the mains electricity on both<sup>3</sup> the **TP-121EDID** and the **TP-122**. The signal from the XGA source is transmitted via CAT 5 cable, decoded and converted at the XGA OUT 15-pin HD (F) connector to the XGA acceptor.
5. On the **TP-122**:
  - Adjust<sup>4</sup> the video output signal level and/or cable compensation equalization level, if required
  - If necessary, set the H SYNC and V SYNC switches<sup>5</sup>, on the underside

---

1 Download up-to-date Kramer user manuals from our Web site at <http://www.kramerelectronics.com>

2 Not supplied. The complete list of Kramer cables is on our Web site at <http://www.kramerelectronics.com>

3 If you cannot connect the power to both the TP-121EDID and TP-122, you can just connect the power to the TP-122

4 Use a screwdriver to carefully rotate the trimmer, adjusting the appropriate level

5 By default, both switches are set down (for negative V SYNC and H SYNC polarity)

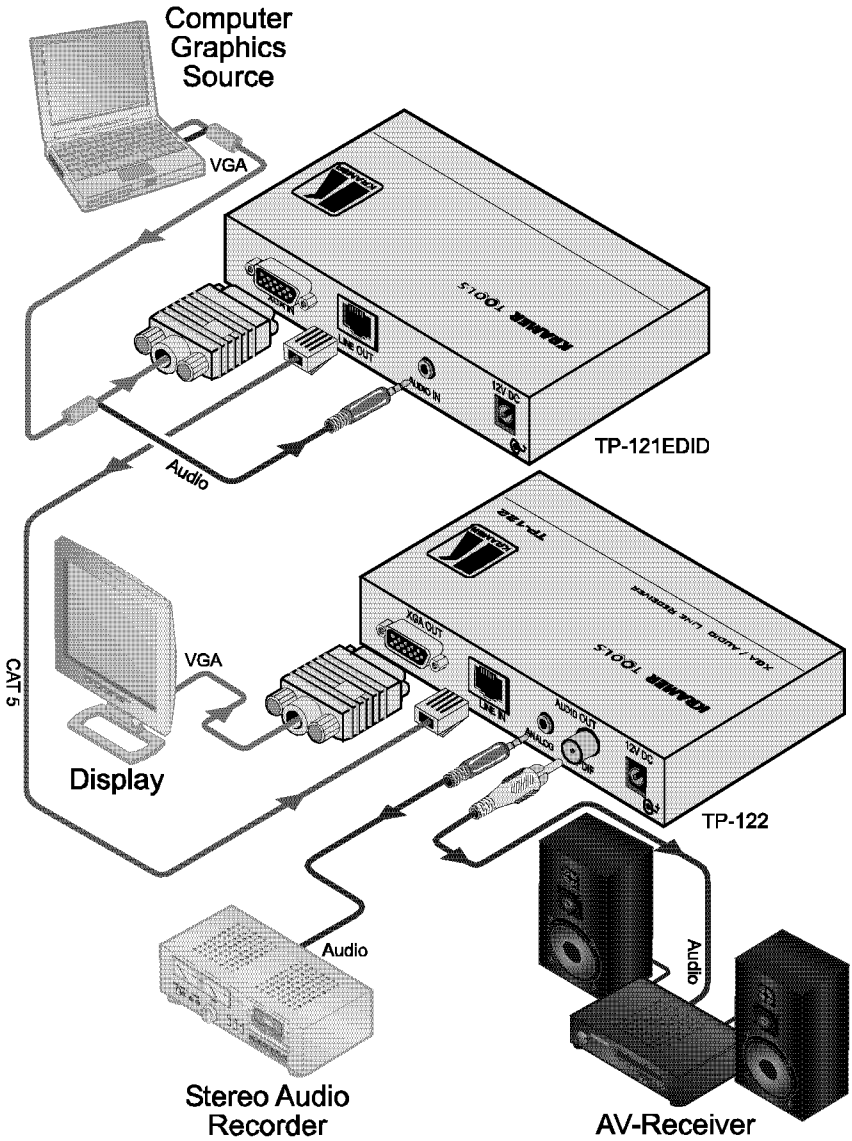

Figure 2: Connecting the TP-121EDID XGA / Audio Line Transmitter

## 4.2 Technical Specifications<sup>1</sup>

Table 2 includes the technical specifications of the **TP-121EDID**

*Table 2: Technical Specifications of the TP-121EDID*

INPUTS:	Video: 1 VGA / UXGA on a 15-pin HD connector Audio: 1 audio ANALOG 3.5mm mini jack
OUTPUT:	1 RJ-45 OUT connector
BANDWIDTH (-3dB) <sup>2</sup> :	Audio: 20Hz to 20kHz@0.5dB
RESOLUTION:	Up to WUXGA and 1080p
S/N RATIO:	VIDEO: 58dB unweighted, 68.3dB @5MHz weighted Audio: <-80dB
TOTAL GAIN:	Audio: Analog/analog: 0dB; Analog/SPDIF: -12dBFS
COUPLING:	AC
TND+N:	Audio: <0.01%
POWER SOURCE:	12V DC 60mA
DIMENSIONS:	12.1cm x 7.18cm x 2.42cm (4.76" x 2.83" x 0.95") W, D, H
WEIGHT:	0.3kg (0.67lbs) approx.
ACCESSORIES:	Power supply
OPTIONS:	19" rack mount adapter

## 5 Your TP-123EDID XGA / Audio / Data Line Transmitter

The **TP-123EDID** is a high-performance transmitter. It accepts a computer graphics input signal, an unbalanced stereo analog audio signal, unidirectional (RxD) RS-232 control commands and 12V DC power, over CAT 5 cable, and transmits to a receiver<sup>3</sup>. The stereo analog audio signal is converted to the digital audio (S/PDIF) stream before transmitting, thus preserving the quality of the audio source signals.

When the **TP-123EDID** is connected to a display device and the EDID CAPTURE button is pressed, the **TP-123EDID** reads and stores the EDID (Extended Display Identification Data) from the display device. The display can be disconnected and later reconnected without rebooting the operating system.

The **TP-123EDID** has a transmission range of more than 300ft (more than 100m) over CAT 5 cabling and can power or be powered by the **TP-124** receiver<sup>4</sup> over the same CAT 5 cable and is 12V DC fed.

<sup>1</sup> Specifications are subject to change without notice

<sup>2</sup> For the Transmitter/Receiver pair

<sup>3</sup> For example, the Kramer TP-124 XGA / Audio / Data Line Receiver

<sup>4</sup> Download up-to-date Kramer user manuals from our Web site at <http://www.kramerelectronics.com>

Figure 3 and Table 3 define the **TP-123EDID**:

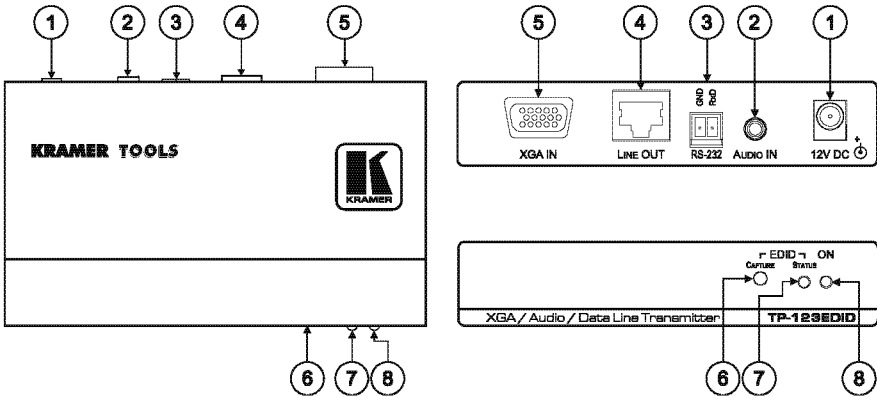

Figure 3: TP-123EDID XGA / Audio / Data Line Transmitter

Table 3: TP-123EDID XGA / Audio / Data Line Transmitter Features

#	Feature	Function
1	12V DC	+12V DC connector for powering the unit
2	AUDIO IN 3.5mm mini jack	Connects to the audio source
3	RS-232 terminal block connector	Connects to the PC or the Remote Controller (see section 5.2)
4	LINE OUT RJ-45 connector	Connects to <sup>1</sup> the LINE IN RJ-45 connector on the TP-124 XGA / Audio Line Receiver
5	XGA IN 15-pin HD (F) connector	Connect to the XGA source
6	EDID <sup>2</sup>	
	CAPTURE Button	Press to acquire the EDID information from the display
	STATUS LED	Illuminates during normal operation; blinks when acquiring the EDID
	ON LED	Illuminates when receiving power

## 5.1 Connecting the TP-123EDID XGA / Audio / Data Line Transmitter

You can use the **TP-123EDID XGA / Audio / Data Line Transmitter** together with the **TP-124 XGA / Audio / Data Line Receiver**<sup>3</sup> to configure a twisted pair transmitter and receiver system, to transmit the video, audio and RS-232 control signals via CAT 5 cable.

Before connecting the transmitter and receiver system you can acquire the EDID from the display or set the system to the default EDID, see section 9.

<sup>1</sup> Using a CAT 5 cable with RJ-45 connectors at both ends (the PINOUT is defined in Table 11 and Figure 11)

<sup>2</sup> See section 9

<sup>3</sup> Download up-to-date Kramer user manuals from our Web site at <http://www.kramerelectronics.com>

To connect the **TP-123EDID** and the **TP-124** to configure a twisted pair transmitter and receiver system, as the example in [Figure 4](#) illustrates, do the following:

1. On the **TP-123EDID**, connect:
  - An XGA source (for example, a laptop's graphics card) to the XGA IN 15-pin HD (F) connector and an audio source to the Audio IN 3.5mm mini jack, for example, using a Kramer C-GMA/GMA cable (VGA 15-pin HD (M) +Audio jack to VGA 15-pin HD (M) +Audio jack)<sup>1</sup>
  - An RS-232 cable with a 9-pin D-sub connector at one end to the laptop, and a 2-pin terminal block connector at the other end to the **TP-123EDID** RS-232 port<sup>2</sup>
2. On the **TP-124**, connect:
  - The XGA OUT 15-pin HD (F) connector to a display
  - The S/PDIF Audio OUT RCA connector to a digital AV Receiver (leave the ANALOG Audio OUT 3.5mm mini jack unconnected)
  - An RS-232 cable with a 2-pin terminal block connector at one end to the **TP-124** RS-232 port<sup>2</sup>, and a 9-pin D-sub connector at the other end to the RS-232 port on an RS-232 controllable device (for example, a switcher)
3. Connect the Line OUT RJ-45 connector on the **TP-123EDID** to the LINE IN RJ-45 connector on the **TP-124**, via CAT 5 cabling<sup>3</sup> (with a range of more than 300ft (>100m)).
4. Connect the 12V DC power adapter to the power socket and connect the adapter to the mains electricity on both<sup>4</sup> the **TP-123EDID** and the **TP-124**.
5. On the **TP-124**:
  - If required, adjust<sup>5</sup> the video output signal level and/or cable compensation equalization level.
  - If necessary, set the H SYNC and V SYNC switches<sup>6</sup>, on the underside

---

1 Not supplied. The full list of Kramer cables is on our Web site at <http://www.kramerelectronics.com>. Alternatively, you can connect an XGA source to the XGA IN 15-pin HD (F) connector, and a separate audio source to the AUDIO IN 3.5mm mini jack

2 As defined in [Figure 5](#) and [Table 4](#) (see section 8)

3 For details of how to wire a CAT 5 LINE IN / LINE OUT RJ-45 connector, see section 8

4 If you cannot connect the power to both the TP-123EDID and TP-124, you can just connect the power to any one unit

5 Use a screwdriver to carefully rotate the trimmer, adjusting the appropriate level

6 By default, both switches are set down (for negative V SYNC and H SYNC polarity)

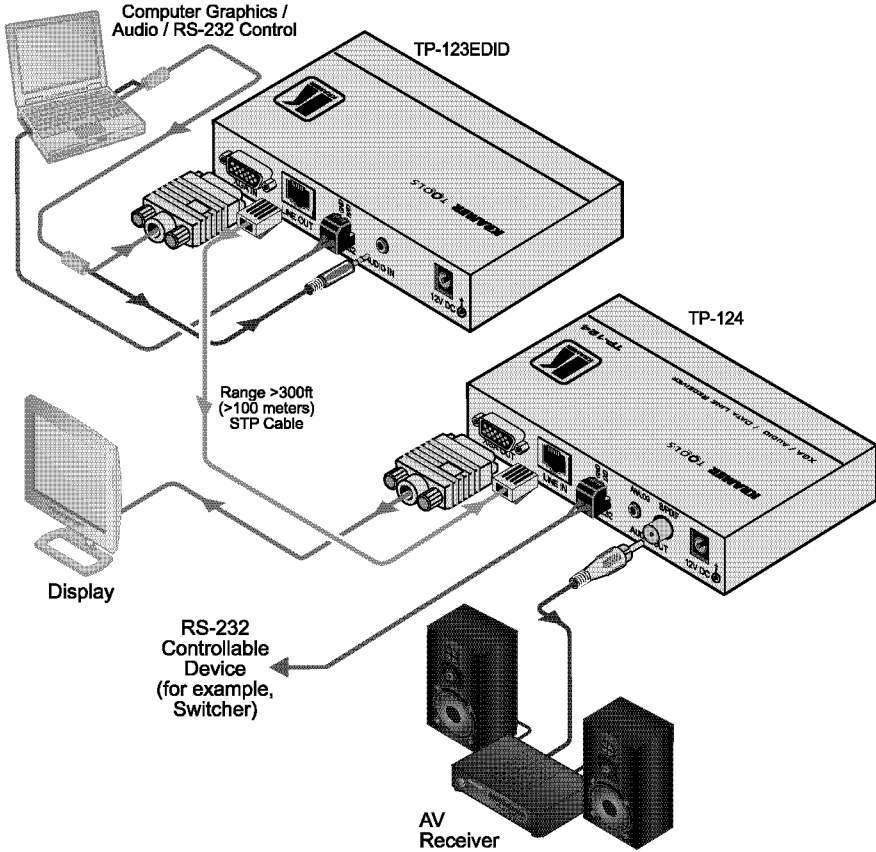

Figure 4: Connecting the TP-123EDID XGA / Audio / Data Line Transmitter

## 5.2 Controlling via RS-232 (for example, using a PC)

Prepare an RS-232 cable with a 9-pin D-sub connector at one end, and a 2-pin terminal block connector at the other end, as defined in [Figure 5](#) and [Table 4](#):

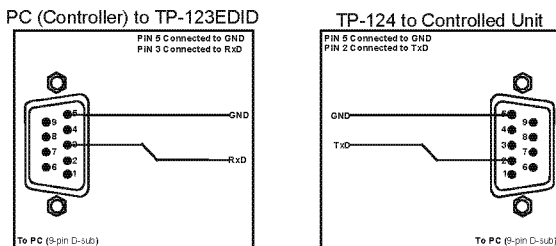

Figure 5: RS-232 PINOUT Connection

Table 4: RS-232 PINOUT Connection

Connect this PIN on the Terminal Block Connector:	To this PIN on the 9-pin D-sub Connector
TxD	PIN 2
RxD	PIN 3
GND	PIN 5

## 5.3 Technical Specifications

[Table 5](#) includes the technical specifications<sup>1</sup> of the **TP-123EDID**:

Table 5: Technical Specifications of the TP-123EDID

INPUTS:	Video: 1 VGA / UXGA on a 15-pin HD connector Audio: 1 audio ANALOG 3.5mm mini jack
OUTPUT:	1 RJ-45 OUT connector
CONTROL:	RS-232 2-pin terminal block
RS-232 BAUD RATE:	Up to 19200kbps
BANDWIDTH (-3dB) <sup>2</sup> :	Audio: 20Hz to 20kHz @0.5dB
RESOLUTION:	Up to WUXGA and 1080p
S/N RATIO:	VIDEO: 58dB unweighted, 68.3dB @5MHz weighted Audio: <-80dB
TOTAL GAIN:	Audio: Analog/analog: 0dB; Analog/SPDIF: -12dBFS
COUPLING:	AC
TND+N:	Audio: <0.01%
POWER SOURCE:	12V DC 60mA
DIMENSIONS:	12.1cm x 7.18cm x 2.42cm (4.76" x 2.83" x 0.95") W, D, H
WEIGHT:	0.3kg (0.67lbs) approx.
ACCESSORIES:	Power supply
OPTIONS:	19" rack mount adapter

<sup>1</sup> Specifications are subject to change without notice

<sup>2</sup> For the Transmitter/Receiver pair

## 6 Your TP-125EDID XGA / Audio / Data Line Transmitter

The **TP-125EDID** is a high-performance transmitter that accepts:

- A computer graphics input signal
- An unbalanced stereo analog audio signal
- RS-232 control commands

The **TP-125EDID** codes the signals and transmits them over CAT 5 cable to a receiver<sup>1</sup>. The stereo analog audio signal is converted to the digital audio (S/PDIF) stream before transmitting, thus preserving the quality of the audio source signals. Commands and data can flow in both directions via the RS-232 interface, allowing status requests and control of the destination unit. The **TP-125EDID** includes H and V Sync internal polarity switches.

When the **TP-125EDID** is connected to a display device and the EDID CAPTURE button is pressed, the **TP-125EDID** reads and stores the EDID (Extended Display Identification Data) from the display device. The display can be disconnected and later reconnected without rebooting the operating system.

Figure 6 and Table 6 define the **TP-125EDID**:

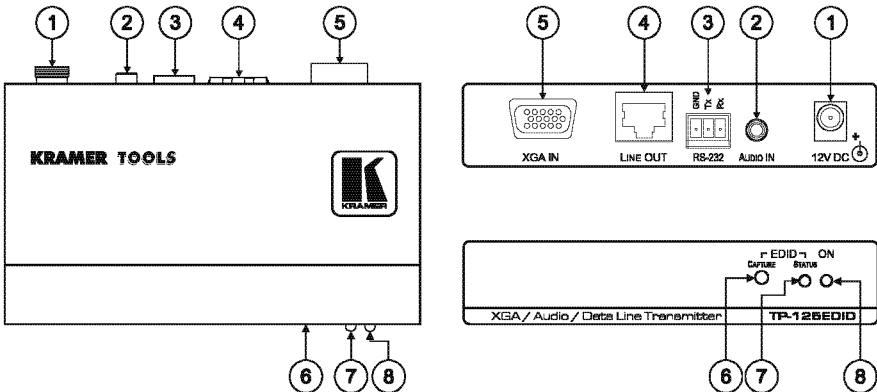

Figure 6: TP-125EDID XGA / Audio / Data Line Transmitter

<sup>1</sup> For example, the Kramer TP-126 UXGA / Audio / Data Line Receiver



Table 6: TP-125EDID XGA / Audio / Data Line Transmitter Features

#	Feature	Function	
1	12V DC	+12V DC connector for powering the unit	
2	AUDIO IN 3.5mm Mini Jack	Connects to the audio source	
3	RS-232 Terminal Block Connector	Connects to the PC or the Remote Controller (see section 5.2)	
4	LINE OUT RJ-45 Connector	Connects to the LINE IN RJ-45 connector on the TP-126 UXGA / Audio Line Receiver	
5	UXGA IN 15-pin HD (F) Connector	Connect to the UXGA source	
6	EDID <sup>1</sup>	CAPTURE Button	Press to acquire the EDID information from the display
7		STATUS LED	Illuminates during normal operation; blinks when acquiring the EDID
8	ON LED	Illuminates when receiving power	

## 6.1 Connecting the TP-125EDID XGA / Audio / Data Line Transmitter

You can use the **TP-125EDID XGA / Audio / Data Line Transmitter** together with the **TP-126 UXGA / Audio / Data Line Receiver**<sup>2</sup> to configure a twisted pair transmitter and receiver system, to transmit the video, audio and RS-232 control signals via CAT 5 cable.

Before connecting the transmitter and receiver system you can acquire the EDID from the display or set the system to the default EDID, see section 9

To connect the **TP-125EDID** and the **TP-126** to create a twisted pair transmitter and receiver system, as the example in [Figure 7](#) illustrates, do the following:

1. On the **TP-125EDID**, connect:
  - An UXGA source (for example, the graphics card on a laptop) to the UXGA IN 15-pin HD (F) connector and an audio source to the Audio IN 3.5mm mini jack, for example, using a Kramer C-GMA/GMA cable (VGA 15-pin HD (M) +Audio jack to VGA 15-pin HD (M) +Audio jack)<sup>3</sup>
  - An RS-232 cable with a 9-pin D-sub connector at one end to the laptop, and a 3-pin terminal block connector at the other end to the **TP-125EDID** RS-232 port<sup>4</sup>
2. On the **TP-126**, connect:
  - The UXGA OUT 15-pin HD (F) connector to the AV display system

<sup>1</sup> See section 9

<sup>2</sup> Download up-to-date Kramer user manuals from our Web site at <http://www.kramerelectronics.com>

<sup>3</sup> Not supplied. The full list of Kramer cables is on our Web site at <http://www.kramerelectronics.com>. Alternatively, you can connect an UXGA source to the UXGA IN 15-pin HD (F) connector, and a separate audio source to the AUDIO IN 3.5mm mini jack

<sup>4</sup> As defined in [Figure 5](#) and [Table 4](#)

- The S/PDIF Audio OUT RCA connector to a digital AV Receiver (leave the ANALOG Audio OUT 3.5mm mini jack unconnected)
  - An RS-232 cable with a 3-pin terminal block connector at one end to the **TP-126** RS-232 port<sup>2</sup>, and a 9-PIN D-SUB connector at the other end to the RS-232 port on the AV display system
3. Connect the Line OUT RJ-45 connector on the **TP-125EDID** to the LINE IN RJ-45 connector on the **TP-126**, via CAT 5 cabling<sup>1</sup> (with a range of more than 300ft (>100m)).
  4. Connect the 12V DC power supply to the power socket and connect the adapter to the mains electricity on both the **TP-125EDID** and the **TP-126**.
  5. On the **TP-126**:
    - Adjust the video output signal level and/or cable compensation equalization level with a screwdriver, if required
    - If necessary, set the H SYNC and V SYNC switches<sup>2</sup>, on the underside

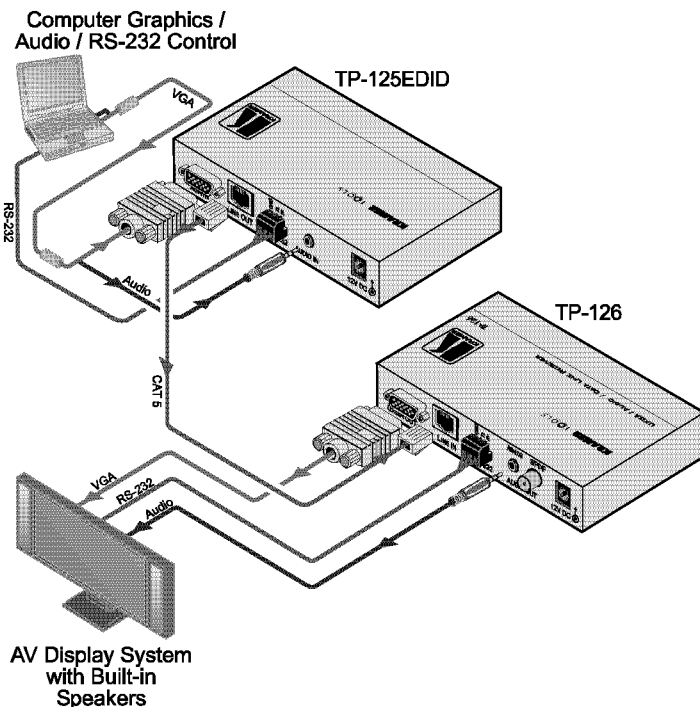

Figure 7: Connecting the TP-125EDID XGA / Audio / Data Line Transmitter

<sup>1</sup> For details of how to wire a CAT 5 LINE IN / LINE OUT RJ-45 connector, see section 8

<sup>2</sup> By default, both switches are set down (for negative V SYNC and H SYNC polarity)

## 6.2 Transmitting via RS-232 (for example, using a PC)

Prepare an RS-232 cable with a 9-pin D-sub connector at one end, and a 3-pin terminal block connector at the other end, as defined in [Table 4](#) and [Figure 5](#):

*Table 7: RS-232 PINOUT Connection*

Connect this PIN on the Terminal Block Connector:	To this PIN on the 9-pin D-sub Connector:
TxD	PIN 2
RxD	PIN 3
GND	PIN 5

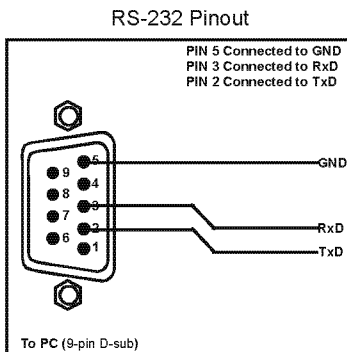

*Figure 8: RS-232 PINOUT Connection*

## 6.3 Technical Specifications<sup>1</sup>

[Table 8](#) includes the technical specifications of the **TP-125EDID**

*Table 8: Technical Specifications of the TP-125EDID<sup>2</sup>*

INPUTS:	Video: 1 UXGA on an 15-pin HD connector Audio: 1 audio ANALOG 3.5mm mini jack
OUTPUT:	1 RJ-45 OUT connector
RESOLUTION:	Up to WUXGA and 1080p
S/N RATIO:	VIDEO: 58dB unweighted, 68.3dB @5MHz weighted Audio: <-80dB
CONTROL:	RS-232 3-pin terminal block
RS-232 BAUD RATE:	Up to 19200kbps
RS-232 MODE:	Full-duplex
BANDWIDTH:	Audio: 20Hz to 20kHz @0.5dB
TOTAL GAIN:	Analog/analog: 0dB, analog/SPDIF: -12dBFS
COUPLING:	AC
TND+N:	Audio: <0.01%
POWER SOURCE:	12 VDC 60mA
DIMENSIONS:	12.1cm x 7.18cm x 2.42cm (4.76" x 2.83" x 0.95"), W, D, H
WEIGHT:	0.3kg. (0.67lbs.) approx.
ACCESSORIES:	Power supply

<sup>1</sup> Specifications are subject to change without notice

<sup>2</sup> With 60m CAT 5 cable

## 7 Your PT-110EDID XGA / Line Transmitter

The **PT-110EDID** is an XGA line transmitter that receives an XGA signal and transmits it over CAT 5 cable to a receiver<sup>1</sup>.

The **PT-110EDID** is pre-programmed with default EDID settings with EDID information ready for the source even before capturing the EDID from the display. When the **PT-110EDID** is connected to a display device and the EDID CAPTURE button is pressed, the **PT-110EDID** reads and stores the EDID (Extended Display Identification Data) from the display device. The display can be disconnected and later reconnected without rebooting the operating system.

In particular, the **PT-110EDID**:

- Has a transmission range of more than 300ft (more than 100m), and a 20kHz audio bandwidth with an S/N ratio that exceeds 80dB on the same transmission range
- Can power or be powered by the receiver over the same CAT 5 cable
- Includes H and V Sync polarity switches
- Is 12V DC fed

Figure 9 and Table 9 define the **PT-110EDID**:

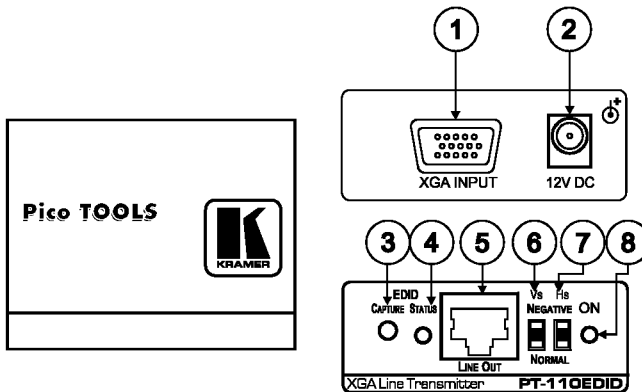

Figure 9: PT-110EDID XGA Line Transmitter

<sup>1</sup> For example, the Kramer TP-122 XGA / Audio Line Receiver

Table 9: PT-110EDID XGA Line Transmitter Features

#	Feature	Function
1	XGA IN 15-pin HD (F) Connector	Connect to the UXGA source
2	12V DC	+12V DC connector for powering the unit
3	EDID <sup>1</sup>	CAPTURE Button
4		STATUS LED
5	LINE OUT RJ-45 Connector	Connects to the LINE IN RJ-45 connector on the <b>TP-120 UXGA / Audio Line Receiver</b>
6	VS Switch	Slide up to set the V SYNC to NEGATIVE polarity; slide down <sup>2</sup> to set the V SYNC to NORMAL polarity
7	HS Switch	Slide up to set the H SYNC to NEGATIVE polarity (NEG); slide down <sup>2</sup> to set the H SYNC to NORMAL polarity
8	ON LED	Illuminates when receiving power

## 7.1 Connecting the PT-110EDID XGA / Line Transmitter

You can use the **PT-110EDID XGA Line Transmitter** together with the **TP-120 XGA Line Receiver**<sup>3</sup> to configure an XGA-to-Twisted Pair Transmitter and Receiver system.

Before connecting the transmitter and receiver system you can acquire the EDID from the display or set the system to the default EDID, see section [9](#)

To connect the **PT-110EDID XGA Line Transmitter** with the **TP-120 XGA Line Receiver**, as the example in [Figure 10](#) illustrates, do the following:

1. On the **PT-110EDID**, connect the XGA source (for example, the 15-pin HD output from a computer's graphics card) to the XGA INPUT 15-pin HD (F) connector.
2. On the **TP-120**, connect the XGA OUT 15-pin HD (F) connector to the XGA acceptor (for example, a monitor).
3. Connect the LINE OUTPUT RJ-45 connector on the **PT-110EDID** to the LINE IN RJ-45 connector on the **TP-120**, via CAT 5 cabling (with a range of more than 300ft (>100m)).
4. On both<sup>4</sup> the **PT-110EDID** and the **TP-120**, connect the 12V DC power adapter to the power socket and connect the adapter to the mains electricity. The signal from the XGA source is transmitted via CAT 5 cable, decoded and converted at the XGA OUT 15-pin HD (F) connector to the XGA acceptor.

<sup>1</sup> See section [9](#)

<sup>2</sup> By default, both switches are set down (for normal V SYNC and H SYNC polarity)

<sup>3</sup> Download up-to-date Kramer user manuals from our Web site at <http://www.kramerelectronics.com>

<sup>4</sup> For distances of up to 100 meters you can connect a power adapter to either the PT-110 or TP-120. Above it, both sides should be fed with power

5. On the **TP-120**, adjust<sup>1</sup> the output signal level and/or cable compensation equalization level, if required.
6. If necessary, set the H SYNC and V SYNC switches<sup>2</sup>, on the units.

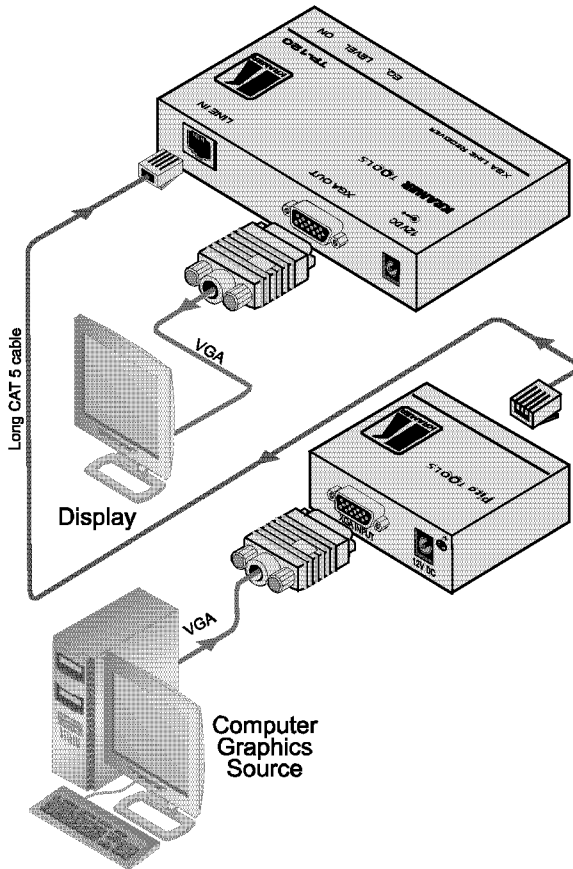

Figure 10: Connecting the PT-110EDID XGA / Line Transmitter

<sup>1</sup> Use a screwdriver to carefully rotate the trimmer, adjusting the appropriate level

<sup>2</sup> By default, both switches are set for normal H SYNC and V SYNC polarity

## 7.2 Technical Specifications<sup>1</sup>

Table 10 includes the technical specifications of the **PT-110EDID**:

Table 10: Technical Specifications of the PT-110EDID<sup>2</sup>

INPUT:	1 VGA / UXGA on a 15-pin HD connector
OUTPUT:	1 RJ-45 LINE OUTPUT connector
RESOLUTION:	Up to UXGA
S/N RATIO:	69dB (worst case)
COUPLING:	AC
POWERSOURCE:	12V DC 60mA
DIMENSIONS:	6cm x 6.5cm x 2.5cm, (2.36" x 2.56" x 1") W, D, H
WEIGHT:	0.14kg (0.31lbs) approx.
ACCESSORIES:	Power supply
OPTIONS:	19-inch rack adapters

## 8 Wiring the CAT 5 LINE IN / LINE OUT RJ-45 Connectors

Table 11 and Figure 11 define the CAT 5 PINOUT, using a straight pin to pin cable with RJ-45 connectors:

Table 11: CAT 5 PINOUT

EIA /TIA 568A		EIA /TIA 568B	
PIN	Wire Color	PIN	Wire Color
1	Green / White	1	Orange / White
2	Green	2	Orange
3	Orange / White	3	Green / White
4	Blue	4	Blue
5	Blue / White	5	Blue / White
6	Orange	6	Green
7	Brown / White	7	Brown / White
8	Brown	8	Brown
Pair 1	4 and 5	Pair 1	4 and 5
Pair 2	3 and 6	Pair 2	1 and 2
Pair 3	1 and 2	Pair 3	3 and 6
Pair 4	7 and 8	Pair 4	7 and 8

Figure 11: CAT 5 PINOUT

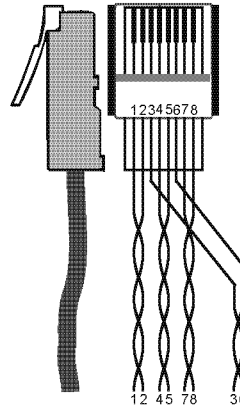

<sup>1</sup> Specifications are subject to change without notice

<sup>2</sup> With 60m CAT 5 cable

## 9 Acquiring the EDID

The transmitter can acquire the EDID information from the display connected to the transmitter or acquire the default EDID.

To acquire the display EDID, do the following:

1. Connect the XGA INPUT 15-pin HD connector to the input XGA connector of the display, using a short cable<sup>1</sup>.
2. Connect the display power.
3. On the Transmitter, connect the 12V DC power adapter to the power socket and connect the adapter to the mains electricity.
4. Press the EDID CAPTURE button.
5. Once the EDID STATUS blinks slowly several times, the EDID is captured.
6. Disconnect the display.

To acquire the default EDID<sup>2</sup>:

1. On the Transmitter, connect the 12V DC power adapter to the power socket and connect the adapter to the mains electricity.
2. Press the EDID CAPTURE button.
3. Once the EDID STATUS blinks rapidly several times, the default EDID is captured.

Alternatively, you can press the EDID CAPTURE button after connecting the transmitter receiver system. When the EDID STATUS LED blinks rapidly several times, the default EDID information is acquired.

---

<sup>1</sup> The EDID is carried over pins 12 and 15 of the VGA connector. It is essential that the cable used for capturing the EDID passes all 15 pins

<sup>2</sup> Do not connect the display to the transmitter when acquiring the default EDID



---

## LIMITED WARRANTY

Kramer Electronics (hereafter *Kramer*) warrants this product free from defects in material and workmanship under the following terms.

### HOW LONG IS THE WARRANTY

Labor and parts are warranted for seven years from the date of the first customer purchase.

### WHO IS PROTECTED?

Only the first purchase customer may enforce this warranty.

### WHAT IS COVERED AND WHAT IS NOT COVERED

Except as below, this warranty covers all defects in material or workmanship in this product. The following are not covered by the warranty:

1. Any product which is not distributed by Kramer, or which is not purchased from an authorized Kramer dealer. If you are uncertain as to whether a dealer is authorized, please contact Kramer at one of the agents listed in the Web site [www.kramerelectronics.com](http://www.kramerelectronics.com).
2. Any product, on which the serial number has been defaced, modified or removed, or on which the WARRANTY VOID IF TAMPERED sticker has been torn, reattached, removed or otherwise interfered with.
3. Damage, deterioration or malfunction resulting from:
  - i) Accident, misuse, abuse, neglect, fire, water, lightning or other acts of nature
  - ii) Product modification, or failure to follow instructions supplied with the product
  - iii) Repair or attempted repair by anyone not authorized by Kramer
  - iv) Any shipment of the product (claims must be presented to the carrier)
  - v) Removal or installation of the product
  - vi) Any other cause, which does not relate to a product defect
  - vii) Cartons, equipment enclosures, cables or accessories used in conjunction with the product

### WHAT WE WILL PAY FOR AND WHAT WE WILL NOT PAY FOR

We will pay labor and material expenses for covered items. We will not pay for the following:

1. Removal or installations charges.
2. Costs of initial technical adjustments (set-up), including adjustment of user controls or programming. These costs are the responsibility of the Kramer dealer from whom the product was purchased.
3. Shipping charges.

### HOW YOU CAN GET WARRANTY SERVICE

1. To obtain service on you product, you must take it prepaid to any authorized Kramer service center.
2. Whenever warranty service is required, the original dated invoice (or a copy) must be presented as proof of warranty coverage, and should be included in any shipment of the product. Please also include in any mailing a contact name, company, address, and a description of the problem(s).
3. For the name of the nearest Kramer authorized service center, consult your authorized dealer.

### LIMITATION OF IMPLIED WARRANTIES

All implied warranties, including warranties of merchantability and fitness for a particular purpose, are limited in duration to the length of this warranty.

### EXCLUSION OF DAMAGES

The liability of Kramer for any effective products is limited to the repair or replacement of the product at our option. Kramer shall not be liable for:

1. Damage to other property caused by defects in this product, damages based upon inconvenience, loss of use of the product, loss of time, commercial loss; or
2. Any other damages, whether incidental, consequential or otherwise. Some countries may not allow limitations on how long an implied warranty lasts and/or do not allow the exclusion or limitation of incidental or consequential damages, so the above limitations and exclusions may not apply to you.

This warranty gives you specific legal rights, and you may also have other rights, which vary from place to place.

**NOTE:** All products returned to Kramer for service must have prior approval. This may be obtained from your dealer.

This equipment has been tested to determine compliance with the requirements of:

- EN-50081: "Electromagnetic compatibility (EMC); generic emission standard.  
Part 1: Residential, commercial and light industry"
- EN-50082: "Electromagnetic compatibility (EMC) generic immunity standard.  
Part 1: Residential, commercial and light industry environment".
- CFR-47: FCC\* Rules and Regulations:  
Part 15: "Radio frequency devices  
Subpart B Unintentional radiators"

### CAUTION!

- ☒ Servicing the machines can only be done by an authorized Kramer technician. Any user who makes changes or modifications to the unit without the expressed approval of the manufacturer will void user authority to operate the equipment.
- ☒ Use the supplied DC power supply to feed power to the machine.
- ☒ Please use recommended interconnection cables to connect the machine to other components.  
\* FCC and CE approved using STP cable (for twisted pair products)



---

**For the latest information on our products and a list of Kramer distributors, visit our Web site: [www.kramerelectronics.com](http://www.kramerelectronics.com), where updates to this user manual may be found. We welcome your questions, comments and feedback.**



**Caution**

**Safety Warning:**

Disconnect the unit from the power supply before opening/servicing.



---

**Kramer Electronics, Ltd.**

Web site: [www.kramerelectronics.com](http://www.kramerelectronics.com)

E-mail: [info@kramerelect.com](mailto:info@kramerelect.com)

P/N: 2900-000585 REV 2