

CAP412

4 x 100V Power Amplifier

AUDAC

PROFESSIONAL AUDIO EQUIPMENT

CAP412 Four Channel 100V Power Amplifier

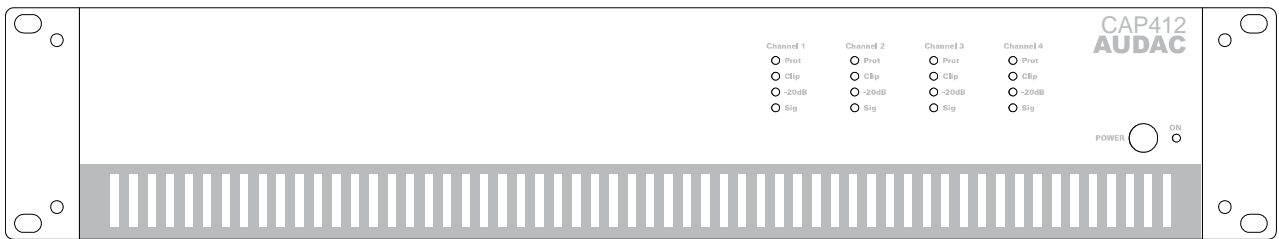

# User Manual & Installation Guide

AUDAC PROFESSIONAL AUDIO EQUIPMENT

# User Manual & Installation Guide

---

© AUDAC  
<http://www.audac.eu>  
[info@audac.eu](mailto:info@audac.eu)

---

# Index

<b>INTRODUCTION</b> .....	<b>3</b>
<b>ENVIRONMENT</b> .....	<b>4</b>
<b>SAFETY REQUIREMENTS</b> .....	<b>5</b>
CAUTION – SERVICING .....	5
<b>OVERVIEW FRONT AND REAR PANEL</b> .....	<b>6</b>
FRONT PANEL OVERVIEW .....	6
REAR PANEL OVERVIEW .....	7
<b>CONNECTING THE AMPLIFIER</b> .....	<b>9</b>
INPUT CONNECTIONS .....	9
CONNECTION STANDARDS .....	9
OUTPUT CONNECTIONS .....	10
<b>BLOCK DIAGRAM</b> .....	<b>12</b>
<b>ADDITIONAL INFORMATION</b> .....	<b>13</b>
TECHNICAL SPECIFICATIONS .....	13
<b>PERSONAL NOTES</b> .....	<b>14</b>

## Introduction

*This section briefly describes the possibilities of the CAP412 four channel power amplifier.*

**T**he CAP412 four channel power amplifier was developed as an easy to use, flexible solution for multifunctional use.

During the development of the CAP412, the AUDAC-engineers wanted to achieve four goals:

- Delivering a flexible audio solution to control multiple functions
- Offering a user-friendly device
- Guaranteeing an excellent sound quality
- Creating a modern and advanced design

The CAP412 is a professional four channel 100V power amplifier which is capable of providing 120 Watt to each of the four separate output channels. This creates a great flexibility and new possibilities for installed Multi-Zone audio distribution systems.

It is designed as a no-nonsense amplifier with only the necessary controls and connections, which creates great simplicity in use and installation. Every output channel contains different power taps to be used in 100 Volt, 70 Volt and even 4 Ohm low impedance applications, and the input signal connections are performed using balanced XLR connectors, allowing link through to other amplifiers.

Besides all the desired connection possibilities, the CAP412 also offers a gain control potentiometer and a high-pass filter switch (400Hz) on the back of the unit. A built-in multipurpose protection circuit protects against DC malfunction, short circuit, overheating, overload, and limits the signal when necessary.

## Environment

**Do not place this unit in an enclosed environment such as a bookshelf or closet. Ensure that there is adequate ventilation to cool the unit. Do not block the ventilation openings.**

**Do not place the unit in environments which contain high levels of dust, heat, moisture or vibration.**

**Do not use the unit near water or other liquids. Make sure no water or other liquids can be spilled, dripped or splashed on the unit.**

**This unit was developed for indoor use only. Do not use it outdoors.**

**Do not place objects on top of the unit.**

**Place the unit on a stable base.**

## Safety Requirements

**Always handle the unit with care.**

**Only use a grounded socket outlet and a power cord with grounding plug to plug in the unit.**

**This unit is not a toy. It should not be operated by children.**

**Do not stick objects through the openings of the CAP412**

**Do not open the unit (risk for electrical shock).**

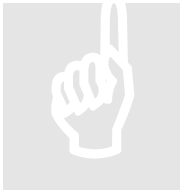

### CAUTION – SERVICING

This unit contains no user serviceable parts. Refer all servicing to qualified service personnel. Do not perform any servicing unless you are qualified to do so.

### Note

This product conforms to the following European Standards: EN 50081-1: 1992, EN 50082-1: 1992, EN 60065: 199

## Overview front and rear panel

### Front panel overview

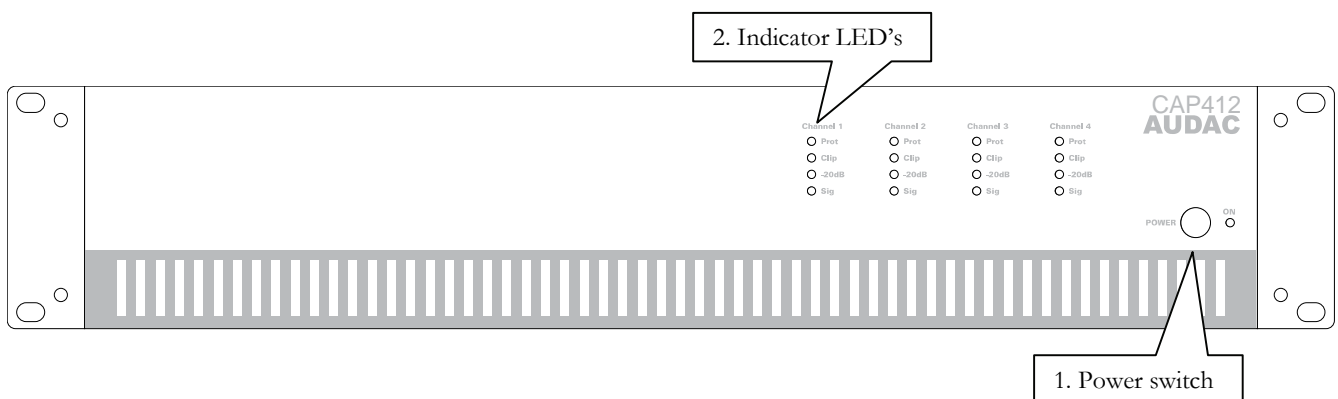

### Description

#### 1. Power switch:

By means of the power switch, the amplifier can be turned ON and OFF. When the amplifier is switched on, the blue LED located next to the power button will illuminate.

#### 2. Indicator LED's:

These four LED's indicate the operation of the amplifier. The green **Signal** LED illuminates whenever a signal is present, while the **-20dB** LED illuminates when the input signal exceeds the -20 dBu level. The **Clip** LED illuminates when the corresponding channel is working at maximum level. To ensure the best signal-to-noise ratio, the Clip LED may only illuminate at peak levels. When the Clip LED illuminates frequently, the amplifier will be overloaded, a distorted "Clipping" sound will be available on the output. The **Protection** LED will illuminate when overheating occurs, or any other fault is detected. When the protection LED is illuminated, no signal will be available on the outputs. The protection LED's will also illuminate for a few seconds when powering up the amplifier, and when the amplifier is switched off they will slowly fade out.

## Rear panel overview

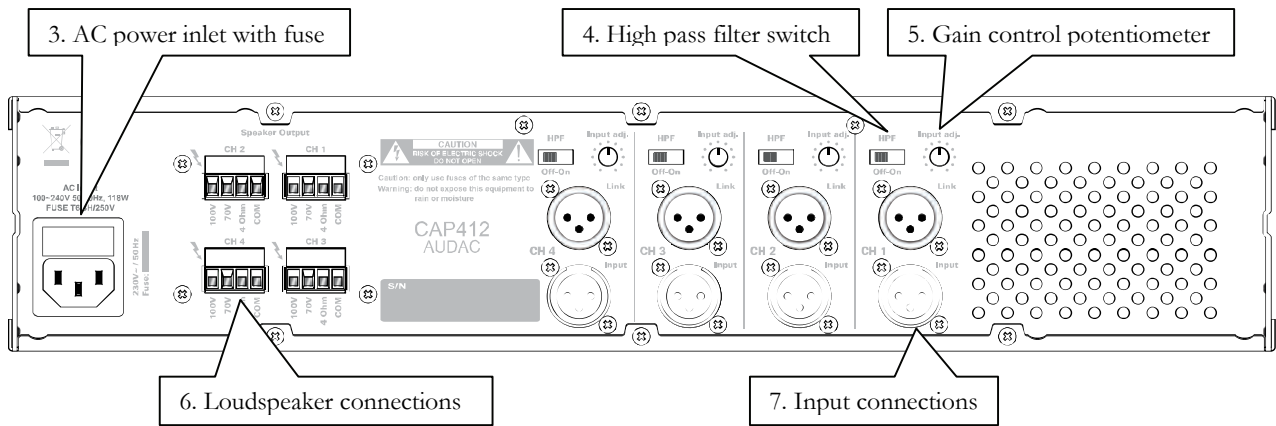

## Description

### 3. AC Power inlet with fuse:

The mains power supply (100~240V AC / 50~60Hz) has to be applied to this AC power inlet. The connection is made by an IEC power connector and is fitted with a fuse. When replacing the fuse, make sure that the value of the replacement fuse matches the value of the original fuse. (T6.3H/250V)

### 4. High pass filter switch:

By means of this switch, the integrated High Pass Filter (HPF) can be switched ON and OFF. When the filter is switched ON, frequencies below 400Hz will be suppressed. This can be useful for eliminating low-frequency hum and noise caused by external equipment and protects speakers from damage caused by excessive low frequency transients.

### 5. Gain control potentiometer:

By means of these potentiometers, the level of each input signal can be adjusted. Make sure the level for every channel is set correctly so no clipping occurs.

### 6. Loudspeaker connections:

The loudspeaker output connections are performed using Euro Terminal Blocks, and provide the possibility for connecting low impedance (4 Ohm) loudspeakers as well as High impedance (100V / 70V) loudspeakers.



## **7. Input connections:**

The input connections of the amplifier are performed using balanced XLR connectors. Every channel has an XLR input connector and a XLR link output connector. The input signal from the signal source, pre-amplifier or mixer should be connected to the XLR input connections. And by means of the XLR link output connectors, the signal can be linked through to multiple amplifiers.

## Connecting the Amplifier

### Note

When connecting the amplifier, make sure the power button is switched OFF.

### Input connections

The input connections of the amplifier are performed using balanced XLR connectors. Every channel has an XLR input connector and a XLR link output connector.

The input signal from the signal source, pre-amplifier or mixer should be connected to the XLR input connections. And by means of the XLR link output connectors, the signal can be linked through to multiple amplifiers.

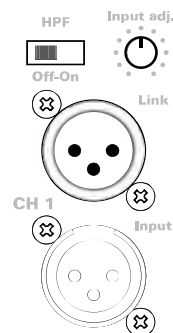

### Connection standards

The in- and output connections of AUDAC audio equipment are performed corresponding to international wiring standards for professional audio equipment.

#### **XLR:**

- 1 = ground / shield
- 2 = +sig
- 3 = -sig

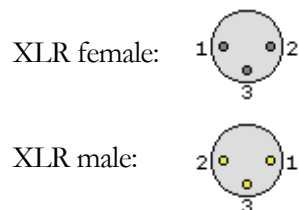

## Output connections

The loudspeaker output connections are performed using Euro Terminal Blocks, and provide the possibility for connecting low impedance (4 Ohm) loudspeakers as well as High impedance (100V / 70V) loudspeakers.

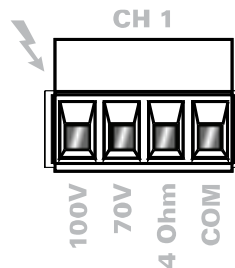

The table below shows the impedance and output voltage for each power tap.

<b>CAP412</b>	4Ω / 22V	41Ω / 70V	83Ω / 100V
---------------	----------	-----------	------------

When connecting the loudspeakers, always maintain proper polarity on the output connectors.

Connect the COM terminal to the negative (-) speaker lead and connect the other suitable terminal to the positive (+) speaker lead.

### **Low impedance applications:**

When using the CAP412 amplifier in low impedance applications, the loudspeakers should be connected between the "COM" and "4 Ohm" connection terminals.

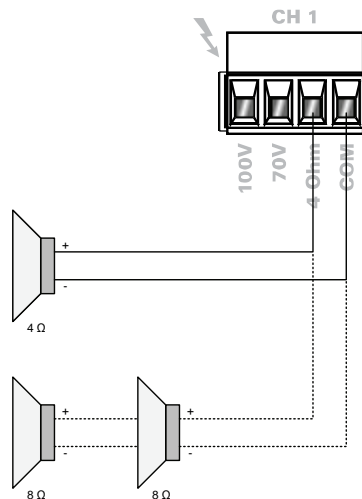

**Constant voltage applications:**

When using the CAP412 amplifier in constant voltage applications, the loudspeakers should be connected between the “COM” and “100V” or “70V” connection terminals.

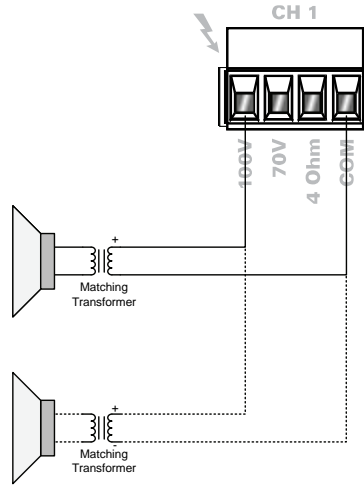

**Attention**

Make sure the loudspeakers are always connected on **Low impedance** outputs **OR** on **Constant voltage** outputs, but **NEVER** use the Low impedance outputs and Constant voltage outputs of the same channel **at the same time**.

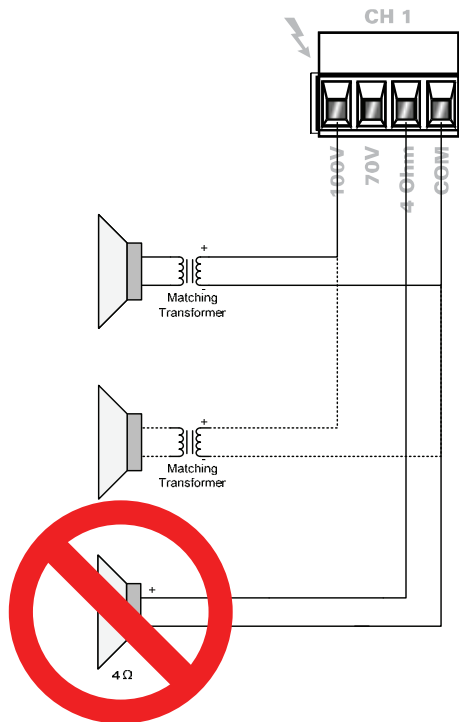

Block Diagram

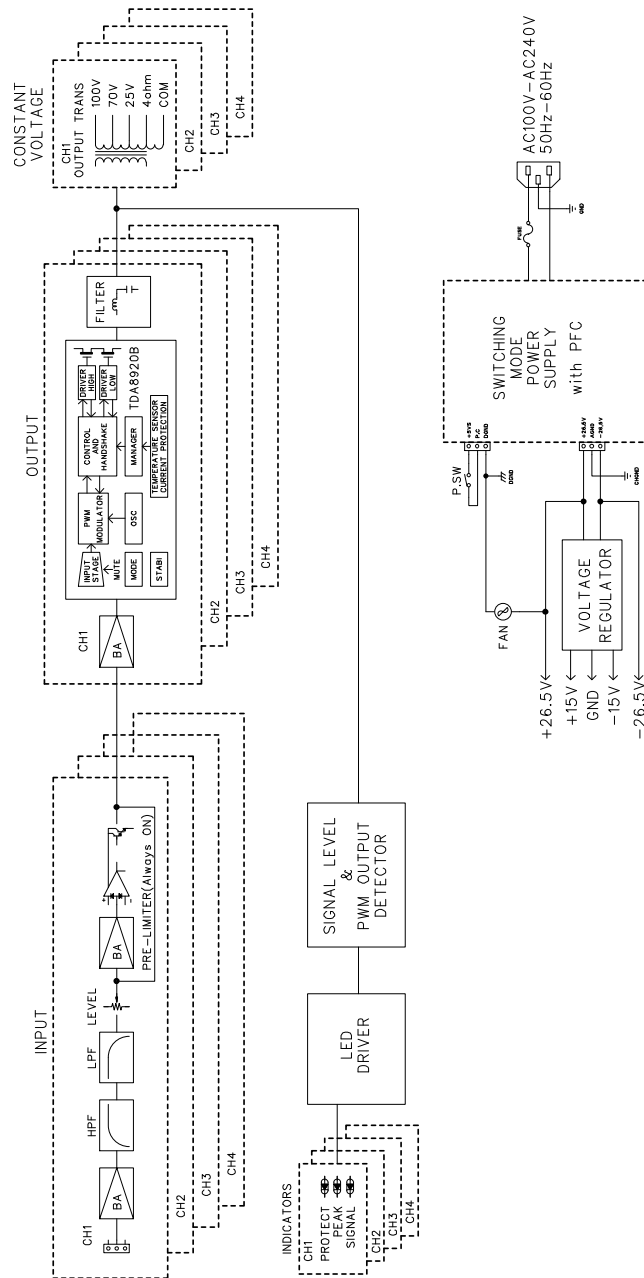

## Additional Information

## Technical specifications

		CAP412
<b>Performance</b>		
Rated power	8 Ohm	75 Watt
	4 Ohm	120 Watt
	100 Volt	120 Watt
Input Sensitivity (Balanced / Impedance 10 kOhm)		1.0 Vrms
Frequency response ( $\pm 1$ dB)		50 Hz – 18 kHz
Signal to Noise ratio		> 90 dB
Channel separation		>70 dB
THD at 1 kHz (1/3 rated power)		Less than 0.01%
Output voltage and impedance		4 $\Omega$ / 22V -
		41 $\Omega$ / 70V
		83 $\Omega$ / 100V
Indicators		Protect (Red / DC, Thermal, Overload)
		Clip (Red / 0 dBr)
		-20 dB(Green / -20 dBr)
		Signal (Green / -26 dBr)
		Power (Blue)
Operation temperature / Humidity		0° ~ 40°C at 95% at non-condensing
Signal connectors		Female XLR in & Male XLR Link
Loudspeaker connectors		4-pin Euro Terminal Block
Power supply		100~240V AC / 50~60 Hz
<b>Construction</b>		
Construction		Steel
Cooling		Fan Ventilated
Mounting		19" Rack
Unit Height		2 HE
Dimensions (W x H x D)		482 x 88 x 420 mm
Color		Black
Net Weight		14.8 Kg

Personal notes