

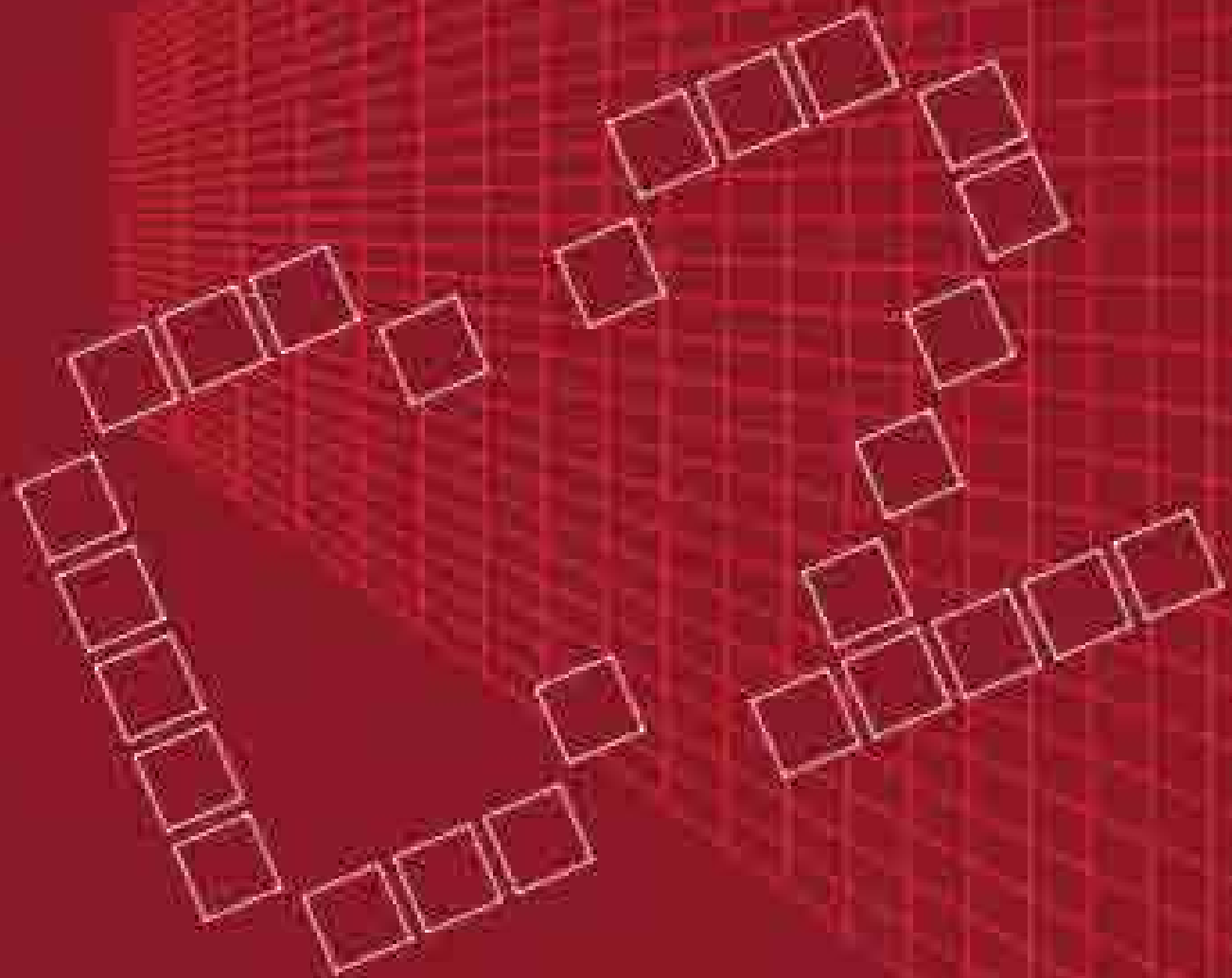

# User Guide

## S2 Switcher Series Operation Manual

Version 2.3



# S2 SWITCHER SERIES OPERATION MANUAL

## S2 SWITCHER SERIES OPERATION MANUAL

### Table of Contents

1	DISCLAIMER .....	1
1.1	Regulatory Agency Acceptance.....	1
1.2	FCC Statement.....	1
1.3	Manual Version Information.....	2
1.4	Manual Copyright Notice .....	2
2	IMPORTANT SAFETY INSTRUCTION.....	3
3	DEVICE SUMMARY .....	13
3.1	Device Capabilities.....	13
3.2	Device Features .....	13
4	PRODUCT IMAGES .....	14
5	S2-105PC, S2-105PCA, S2-109PC .....	17
5.1	Video/Audio inputs and outputs.....	17
5.2	Front panel buttons.....	18
5.3	Default settings.....	18
5.4	'Windows® Control Panel' control .....	18
5.5	OPTION cable control .....	18
5.6	Remote control .....	19
5.7	Locking out the IR remote control.....	19
5.8	S2-105PCA extra features.....	19
6	S2-105CV, S2-105CVA & S2-110CV .....	20
6.1	Video/Audio inputs and outputs.....	20
6.2	Front panel buttons.....	21
6.2.1	Auto and manual termination.....	21
6.3	Default settings.....	21
6.4	'Windows® Control Panel' control .....	21
6.5	OPTION cable control .....	22
6.6	Remote control .....	22
6.7	Locking out the IR remote control.....	23
6.8	S2-105CVA extra features.....	23
7	S2-105YC, S2-105YCA & S2-110YC .....	24
7.1	Video/Audio inputs and outputs.....	24
7.2	Front panel buttons.....	25
7.2.1	Auto and manual termination.....	25
7.3	Default settings.....	25

## S2 SWITCHER SERIES OPERATION MANUAL

7.4	'Windows® Control Panel' control .....	25
7.5	OPTION cable control .....	26
7.6	Remote control .....	26
7.7	Locking out the IR remote control .....	26
7.8	S2-105YCA extra features .....	27
8	S2-105DVIA .....	28
8.1	Video/Audio inputs and outputs .....	28
8.2	Front panel buttons .....	28
8.3	Default settings .....	29
8.4	'Windows® Control Panel' control .....	29
8.5	OPTION cable control .....	29
8.6	Remote control .....	29
8.7	Locking out the IR remote control .....	30
8.8	S2-105DVIA extra features .....	30
9	S2-101AA .....	31
9.1	Audio inputs and outputs .....	31
9.2	Front panel buttons .....	31
9.3	Default settings .....	31
9.4	'Windows® Control Panel' control .....	32
9.5	OPTION cable control .....	32
9.6	Remote control .....	32
9.7	Locking out the IR remote control .....	32
9.8	S2-101AA extra features .....	32
10	S2-106AD .....	33
10.1	Audio inputs and outputs .....	33
10.2	Front panel buttons .....	34
10.2.1	Multi-directional switch .....	34
10.3	Default settings .....	34
10.4	'Windows® Control Panel' control .....	34
10.5	OPTION cable control .....	34
10.6	Remote control .....	35
10.7	Locking out the IR remote control .....	35
10.8	Menu layout and settings adjustment .....	35
10.9	The Menu Structure .....	36
10.10	Settings .....	36
10.11	Menu description .....	37

## S2 SWITCHER SERIES OPERATION MANUAL

11	S2-108HD .....	40
11.1	Video/Audio inputs and outputs.....	40
11.2	Front panel buttons.....	40
11.2.1	Auto Operation .....	40
11.3	Default settings.....	41
11.4	'Windows® Control Panel' control .....	41
11.5	OPTION cable control .....	41
11.6	Remote control.....	42
11.7	Locking out the IR remote control .....	42
12	INFRA-RED REMOTE CONTROL.....	43
12.1	S2-106AD operation .....	43
12.2	S2-101AA operation .....	43
12.3	Video switcher operation .....	43
12.4	Purchasing an infra-red controller.....	43
13	OPTION CABLE CONTROL FOR MULTIPLE UNITS .....	45
13.1	OPTION cable connections .....	45
13.2	Audio connections.....	45
13.3	OPTION control limitations .....	48
14	RS232 CONTROL.....	49
14.1	Connection .....	49
14.2	Communications protocol .....	49
15	TROUBLESHOOTING AND TECHNICAL SUPPORT .....	50
15.1	Your unit does not power up.....	50
15.2	There is no picture on the Output of your video switcher.....	50
15.3	There is no audio on the output of your S2-106AD audio switcher.....	50
15.4	There is no audio on the output of your S2-101AA Audio Amplifier.....	51
15.5	The controls are not responding.....	51
15.6	The C2 unit menu does not expand.....	51
15.7	The wrong video is routed. ....	51
16	RETURN PROCEDURE .....	52
16.1	Are you sure there's a fault?.....	52
16.2	To return a unit for repair.....	52
17	WARRANTY POLICY .....	54
18	CONNECTOR PINOUTS.....	55
18.1	HD15 connector .....	55
18.2	DVI-D connector.....	55

## S2 SWITCHER SERIES OPERATION MANUAL

18.3	4 Pin mini-DIN S-video connector (YC) input.....	56
18.4	RS232 / D9 socket.....	56
18.5	Multi-way audio connector on C2 unit (unbalanced) .....	56
18.6	Multi-way audio connector on S2 unit (balanced) .....	57
19	SPECIFICATIONS .....	58
19.1	S2-105PC(A), S2-109PC Computer Input / Output.....	58
19.2	S2-105CV(A) Composite Input / Output.....	58
19.3	S2-105YC(A) YC Input / Output.....	58
19.4	S2-105DVIA Input / Output.....	58
19.5	S2-101AA Input / Output .....	58
19.6	S2-106AD Audio Input / Output .....	59
19.7	S2-108HD Video Input / Output.....	59
19.8	Warranty.....	60
19.9	Regulatory Compliance .....	60
19.10	Environmental .....	60
19.11	Power Requirement.....	60
19.12	Control Methods .....	60
19.13	Accessories Included.....	60
19.14	Mechanical .....	60
19.15	Optional Accessories.....	60
20	CONTACT INFORMATION.....	61

# 1 DISCLAIMER

This product is intended for professional and/or home use. This product is not intended for use in a medical environment and does not have the required certifications for such use. Similarly, use aboard any aircraft or spacecraft while in flight or as an adjunct to any surface, airborne or marine navigation system or any offshore marine activity, including control of any watercraft, or any use similar to those specifically herein mentioned is prohibited. Use in the aforementioned circumstances would require additional testing and certification.

You have not become the owner of any software - you have merely purchased the right to use the software. You may make one copy of the software for your own use. Other copies will be deemed a breach of copyright.

No warranty is made either expressed or implied including but not limited to any implied warranties of merchantability or fitness for a particular purpose. In no event shall the supplier or manufacturer of this product be liable for errors found within, or be liable for any direct, indirect or consequential damages or loss in connection with the purchase or use of this hardware software or manual. The sole and exclusive liability to the supplier and manufacturer regardless of the form of action shall not exceed the replacement cost of the materials described herein.

By using this equipment you have indicated that you have agreed to the terms listed above. If you do not wish to agree or the above terms are contrary to your conditions of purchase you may return the equipment, unused, to your supplier. All trademarks and copyrights are acknowledged. E&OE.

## 1.1 Regulatory Agency Acceptance

### European 'CE' Mark Statement

Emissions: BS EN 61000-6-3:2001 (Generic Immunity Standard for Residential, Commercial and Light Industrial)

Immunity: BS EN 61000-6-1:2001 (Generic Immunity Standard for Residential, Commercial and Light Industrial)

## 1.2 FCC Statement

Class A Device: This equipment has been tested and found to comply with the limits for a Class A digital device pursuant to Part 15 of the FCC Rules. These limits are designed to provide a reasonable protection against harmful interference when the equipment is operated in a commercial environment. This equipment generates, uses and can radiate radio frequency energy and, if not installed and used in accordance with the Instruction Manual, may cause harmful interference to radio communications. Operation of this equipment in a residential area is likely to cause harmful interference in which case the user will be required to correct the interference at his own expense.

Caution: This equipment is intended for use in the manner prescribed in the Instruction Manual. Any user changes or modifications not expressly approved by TV

One Multimedia Solutions could void the user's authority to operate the equipment. Connecting this equipment to external devices requires no specially shielded cabling for FCC compliance. The Instruction Manual shows or describes the proper connection of this equipment for operation that insures FCC compliance.

Direct all inquiries regarding FCC compliance to:

TV One Multimedia Solutions  
1350 Jamike Drive  
Erlanger, KY 41018  
859.282.7303  
859.282.8225 (Fax)

### **1.3 Manual Version Information**

Version: 2.2  
Release Date: June, 2008

### **1.4 Manual Copyright Notice**

This Operation Manual is the intellectual property of TV One, ©2007-2008. No portion of this manual may be copied or reproduced in any manner or by any means, including, but not limited to electronic and electro-mechanical, without the express written permission of TV One.



## **2 IMPORTANT SAFETY INSTRUCTION**

To insure the best from this product, please read this manual carefully. Keep it in a safe place for future reference.

To reduce the risk of electric shock, do not remove the cover from the unit. No user serviceable parts inside. Refer servicing to qualified personnel.

### **2.1 Power and connections**

This unit is not disconnected from the AC power source as long as it is connected to the wall outlet via an adapter. The off state for this unit is called standby mode. In standby mode the unit is designed to consume a reduced quantity of power compared to normal operating modes.

When not using the unit for a long period of time, ensure that the AC power adapter is disconnected from the wall outlet.

The AC wall outlet should be installed near to the unit and be easily accessible.

Do not plug in or attempt to operate an obviously damaged unit.

### **2.2 Water and moisture**

To reduce the risk of fire and personal injury, operation of this device outdoors and/or exposure to rain, water or excessive moisture is expressly prohibited.

The apparatus shall not be exposed to dripping or splashing and no objects filled with liquids, such as vases, shall be placed on the apparatus.

### **2.3 General care**

Do not force switches or external connections.

When moving the unit, disconnect the serial port connections first then the power cable and finally the interconnecting cables to other devices.

Do not attempt to clean the unit with chemical solvents or aerosol cleaners, as this may damage the unit. Use a clean dry cloth.

### **2.4 Location**

Installation of this unit should be in a cool dry place, away from sources of excessive heat, vibration, dust, moisture and cold.

## **2.5 Ventilation**

Slots and openings in the sides of the unit are provided for ventilation. To ensure reliable operation, avoid obstruction of these openings and ensure the unit is installed in a well-ventilated area.

## **2.6 Intellectual property**

Some IC chips in this product include confidential and/or trade secret property. Therefore you may not copy, modify, adapt, translate, distribute, reverse engineer, reverse assemble or decompile the contents thereof.

## **2 IMPORTANT: CONSIGNES DE SECURITE**

Afin de tirer le meilleur de ce produit, merci de lire attentivement ce manuel. Gardez-le dans un endroit sûr pour pouvoir le consulter à nouveau.

Afin de réduire le risque de choc électrique, ne retirez pas l'unité de sa protection.

Aucune pièce réparable par l'utilisateur à l'intérieur. Référez-vous à des personnes qualifiées.

### **2.1 Alimentation électrique et connexions**

Cette unité n'est pas déconnectée de la source de courant électrique tant qu'elle est connectée à la prise murale. Le mode éteint de cette unité est appelé mode de veille. En mode de veille, cette unité est conçue pour consommer une quantité réduite de courant par rapport aux modes normaux d'utilisation.

Lorsque vous n'utilisez pas l'unité pendant une longue période, assurez-vous que le câble d'alimentation électrique est déconnecté de la prise murale.

La prise murale de courant doit être installée près de l'unité et aisément accessible.

Ne branchez pas et n'essayez pas d'utiliser une unité visiblement endommagée.

### **2.2 Eau et humidité**

Pour réduire les risques d'incendie et de dommages corporels, l'utilisation de cet appareil à l'extérieur et/ou son exposition à la pluie, l'eau ou une humidité excessive est expressément interdite.

L'appareil ne doit pas être exposé aux gouttes ou aux éclaboussures et aucun objet contenant de l'eau, comme par exemple un vase, ne doit être posé sur l'appareil.

### **2.3 Entretien général**

Ne forcez pas les boutons ou connexions externes.

Lorsque vous déplacez l'unité, déconnectez d'abord les connexions de ports en série puis le câble d'alimentation et enfin les câbles de connexion avec d'autres appareils.

N'essayez pas de nettoyer l'unité avec des dissolvants chimiques ou des produits nettoyants en aérosol, car cela peut endommager l'unité. Utilisez un chiffon propre et sec.

### **2.4 Emplacement**

L'installation de cette unité doit se faire dans un endroit frais et sec, éloigné de sources excessives de chaleur, de vibrations, de poussière, d'humidité et de froid.

## **2.5 Aération**

Les rainures et les ouvertures sur les cotés de l'unité servent à l'aérer. Pour permettre une utilisation sûre, évitez d'obstruer ces ouvertures et assurez-vous que l'unité est installée dans un endroit bien aéré.

## **2.6 Propriété intellectuelle**

Certaines puces IC dans ce produit contiennent des éléments propriétaires confidentiels et/ou des secrets commerciaux. Vous ne devez donc pas copier, modifier, adapter, traduire, distribuer, démonter, désassembler, ou décomposer leur contenu.

## **2 INSTRUCCIONES IMPORTANTES DE SEGURIDAD**

Para sacar el mejor provecho de este producto, léase este manual con detenimiento. Guárdelo en un lugar seguro para poder hacerle referencia en el futuro.

Para reducir el riesgo de calambre, no quite la cubierta del aparato.

No hay piezas utilizables dentro. Remítase todo mantenimiento a personal cualificado.

### **2.1 Corriente y conexiones**

Mientras esté conectada a una toma de electricidad, el aparato seguirá conectado a la fuente de corriente CA. A la posición de «off» de este aparato se le denomina posición de espera. En la posición de espera, el aparato está diseñado a consumir una cantidad reducida de electricidad en comparación con los modos de operación normales.

Asegúrese de desconectar el cable de corriente CA de la toma de la pared cuando no va a utilizar el aparato por un periodo largo de tiempo.

La toma CA de la pared ha de estar instalada cerca del aparato y debe ser fácilmente accesible.

No enchufe ni intente operar un aparato que esté evidentemente dañado.

### **2.2 Agua y humedad**

Para reducir el riesgo de fuego o de daños personales, se prohíbe la utilización de este aparato en el exterior y/o su exposición a la lluvia, al agua o a atmósferas de excesiva humedad.

El aparato no debe situarse cerca de zonas en las que haya riesgo de goteo o salpicaduras. Tampoco deben colocarse objetos que contengan agua (jarrones, por ejemplo) en el mismo.

### **2.3 Cuidado general**

No forzar interruptores o conexiones externas.

Al mover el aparato, desconecte las conexiones del puerto en serie primero, luego el cable de electricidad y finalmente los cables interconectados a otros aparatos. No intente limpiar el aparato con disolventes químicos o productos de limpieza aerosol, ya que podrían dañar el aparato. Utiliza un paño limpio y seco.

## **2.4 Ubicación**

Este aparato se debe instalar en un lugar seco y fresco, lejos de fuentes de calor excesivas, la vibración, el polvo, la humedad y el frío.

## **2.5 Ventilación**

El aparato viene provisto de ranuras y agujeros en los lados para la ventilación.

Para asegurar una operación eficaz, se debe evitar la obstrucción de estos agujeros y también asegurar que el aparato se instale en una zona con adecuada ventilación.

## **2.6 Propiedad intelectual**

Algunos chips con circuito integrado de este producto incluyen propiedad confidencial y/o propiedad de secreto comercial. Por lo tanto queda prohibido copiar, modificar, adaptar, traducir, distribuir, usar técnicas retroactivas, desmontar, o recopilar los contenidos del mismo.

## **2 WICHTIGE SICHERHEITSVORSCHRIFTEN**

Lesen Sie diese Bedienungsanleitung bitte sorgfältig, um Ihr Produkt optimal nützen zu können, und bewahren Sie sie zum späteren Nachschlagen an einem sicheren Ort auf.

Entfernen Sie bitte keinesfalls die Abdeckung, um der Gefahr eines Stromschlags vorzubeugen.

Im Inneren des Geräts befinden sich keine Teile, die vom Benutzer gewartet werden können. Lassen Sie Wartungsarbeiten nur von Fachpersonal durchführen.

### **2.1 Stromversorgung und anschlüsse**

Solange das Gerät mit einer Steckdose verbunden ist, bleibt die Stromversorgung aufrecht. Der Ausschaltzustand des Geräts wird als Standbymodus bezeichnet. Im Standbymodus verbraucht das Gerät weniger Strom als in den üblichen Betriebsarten.

Wird das Gerät über einen längeren Zeitraum hinweg nicht verwendet, ziehen Sie bitte das Stromkabel aus der Steckdose.

Die Steckdose sollte sich in der Nähe des Geräts befinden und leicht zugänglich sein.

Verbinden Sie ein offensichtlich beschädigtes Gerät keinesfalls mit einer Steckdose und versuchen Sie auch nicht, es zu bedienen.

### **2.2 Wasser und feuchtigkeit**

Um die Gefahr eines Brandes oder einer Körperverletzung zu verringern, ist es ausdrücklich verboten, dieses Gerät im Freien in Betrieb zu nehmen und/oder es Regen, Wasser oder hoher Feuchtigkeit auszusetzen.

Das Gerät darf keinen Tropfen oder Spritzern ausgesetzt werden und es dürfen keine mit Flüssigkeiten gefüllte Behälter, wie Vasen, auf das Gerät gestellt werden.

### **2.3 Allgemeine pflege**

Wenden Sie bei der Handhabung von Schaltern und Anschlüssen keine Gewalt an.

Beim Umstellen des Geräts entfernen Sie zuerst die seriellen Anschlüsse, dann das Stromkabel und zum Schluss die Verbindungskabel zu anderen Geräten.

Versuchen Sie keinesfalls, das Gerät mit chemischen Lösungsmitteln oder Sprayreinigern zu reinigen, da dies das Gerät beschädigen könnte. Verwenden Sie ein sauberes, trockenes Tuch.

### **2.3 Aufstellung**

Das Gerät sollte an einem kühlen, trockenen Ort aufgestellt werden, fern von übermäßiger Wärme, Vibrationen, Staub, Feuchtigkeit und Kälte.

### **2.5 Belüftung**

Seitliche Schlitze und Öffnungen sorgen für die Belüftung des Geräts. Um die ordnungsgemäße Belüftung zu gewährleisten, dürfen diese Öffnungen nicht verdeckt werden. Sorgen Sie außerdem dafür, dass das Gerät an einem gut belüfteten Ort aufgestellt wird.

### **2.6 Gewerbliches Eigentum**

Einige integrierte Schaltkreise in diesem Produkt enthalten vertrauliche

Informationen und/oder Betriebsgeheimnisse. Sie dürfen daher diese Inhalte nicht kopieren, modifizieren, adaptieren, übersetzen, verteilen, rückentwickeln, rückassemblieren oder dekompilieren.



## **2 BELANGRIJKE VEILIGHEIDSINSTRUCTIES**

Lees deze handleiding zorgvuldig door om het beste uit uw product te halen. Bewaar het op een veilige plek voor raadpleging in de toekomst.

Haal nooit het omhulsel van de eenheid af, dit om de kans op een elektrische schok te verminderen. Maak het apparaat nooit open: er bevinden zich geen door de gebruiker in te stellen onderdelen in het apparaat. Laat service en onderhoud over aan een gekwalificeerde technicus.

### **2.1 Elektriciteit en aansluiting**

Deze eenheid is niet van de wisselstroom voedingsbron gescheiden wanneer de stekker nog in het stopcontact zit. Wanneer de eenheid uitstaat, staat deze nog in de stand-by modus. In de stand-by modus vergt de eenheid minder stroom dan in de normale "aan" modus.

Wanneer u de eenheid voor langere tijd niet gebruikt, zorg er dan voor dat de stekker van het wisselstromsnoer uit het stopcontact is getrokken.

Het wisselstroom stopcontact moet dichtbij de eenheid geïnstalleerd worden en makkelijk toegankelijk zijn.

Als de eenheid duidelijk beschadigd is moet u deze nooit op het lichtnet aansluiten of bedienen.

### **2.2 Water en vocht**

Om het risico op brand en persoonlijk letsel te beperken is het gebruik van dit apparaat buiten en/of blootstelling aan regen, water of overdadige hoeveelheden vocht uitdrukkelijk verboden.

Het apparaat mag niet worden blootgesteld aan druppels of bespatting en er mogen geen objecten die gevuld zijn met vloeistoffen, zoals vazen, op het apparaat geplaatst worden.

### **2.3 Algemeen onderhoud**

Forceer schakelaars of externe aansluitingen nooit.

Bij verplaatsing van de eenheid, de seriële poortaansluitingen eerst loskoppelen, dan de voedingskabel en als laatste de snoeren naar andere apparaten.

Probeer de eenheid nooit met chemische oplosmiddelen of schoonmaakmiddelen in een spuitbus schoon te maken, omdat dit de eenheid kan beschadigen. Gebruik een schone droge doek.

## **2.4 Plaatsing**

Deze eenheid moet geïnstalleerd worden op een koele droge plaats, uit de buurt van bronnen van extreme hitte, vibraties, stof, vocht en kou.

## **2.5 Ventilatie**

De sleuven en openingen aan de zijkant van de eenheid zijn voor ventilatie. Zorg er voor dat de eenheid op een goed geventileerde plek geïnstalleerd wordt zodat deze betrouwbaar werkt.

## **2.6 Intellectueel eigendom**

Sommige IC chips in dit product bevatten vertrouwelijke informatie en/of fabrieksgeheimen. U mag daarom de inhoud hiervan niet kopiëren, wijzigen, aanpassen, vertalen, verspreiden, nabouwen, of decompileren

## **3 DEVICE SUMMARY**

### **3.1 Device Capabilities**

The S2 series of switcher units are predominantly designed as input port expanders for the CORIO® C2-1000, C2-2000 and (for some S2 units) C2-7000 series Scan converters and scalars – although they can also be used as stand-alone signal switchers. They are a family of compact (half-rack), high bandwidth, high performance routing switchers designed to meet the most demanding requirements for signal routing.

Complementary to the range is the S2-101AA stereo audio power amplifier, providing at least 10 Watts per channel into 4 ohm speakers, from audio signal levels provided by the rest of the range.

S2 range switchers are available to support most common types of video signal formats including RGBHV, RGBS, RGsB, YPbPr, Composite Video, S-Video (Y/C) and DVI as well as stereo audio balanced and unbalanced. EDID and HDCP are also supported on some models with resolutions up to UXGA.

Some units (typically those ending with 'A' such as the S2-105PCA) support “audio follow video” switching. The S2-106AD stereo audio switcher also includes adjustments for volume, balance and audio delay up to 1 second for lip-sync - all controlled via an easy to use menu.

The S2 range is designed with ease of use and reliability in mind, utilizing intuitive simple to use controls and interfaces, as well as rugged metal cases for robustness in tough environments.

The switchers can be used stand alone, or when combined with the CORIO® series scan converters and scalars, form a powerful toolset for high quality audio video signal processing for virtually any application.

### **3.2 Device Features**

#### **Simple control**

Each unit can be controlled in various ways. One option is to control using the keys on the front of the unit. Another option would be to control the unit from an infra-red remote control. They can also be controlled via RS-232 using the Windows® Control Panel which is available for download from our Internet site

#### **Upgradeability**

All S2 units benefit from firmware upgradeability, thus reducing product obsolescence by allowing the installation of the latest version of firmware. This only applies to the software used to control the unit, and not its actual functionality. Some units may be able to benefit from the addition of new features, but the majority of S2 units have a dedicated architecture. See <http://www.tvone.com/support> for more detail.

## 4 PRODUCT IMAGES

Your S2 unit should look like one of the images below.

Video switchers support switching of PC, composite, YC and DVI video signals, and models with an A suffix additionally support stereo audio.

The S2-106AD supports five fully balanced stereo inputs, one un-balanced PC audio input and a balanced output with an LCD display, whilst the S2-101AA stereo audio power amplifier supports balanced and un-balanced stereo inputs and 4 ohm speaker outputs.

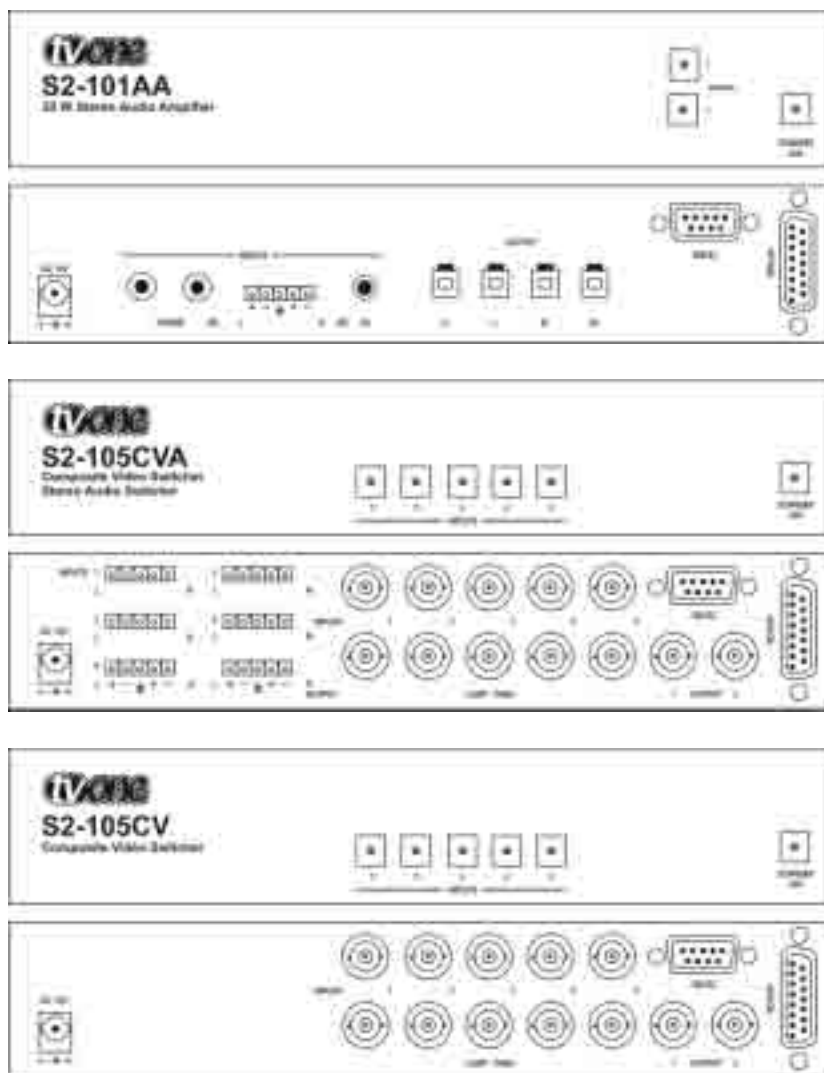

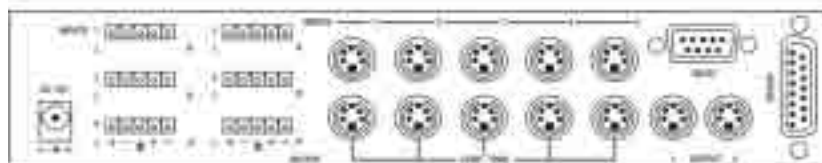
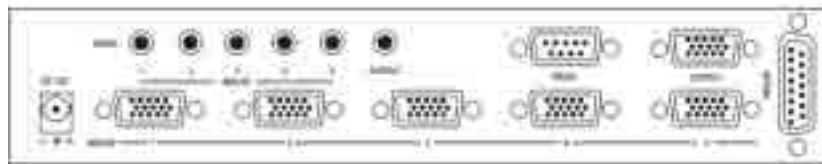
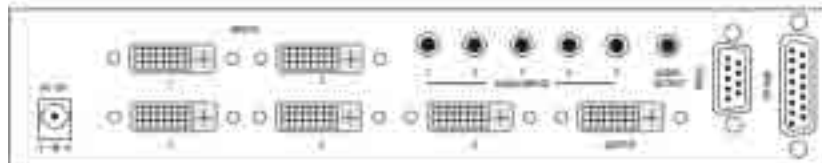
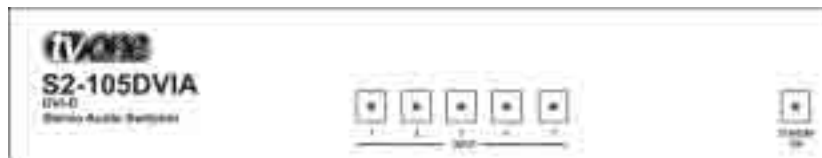

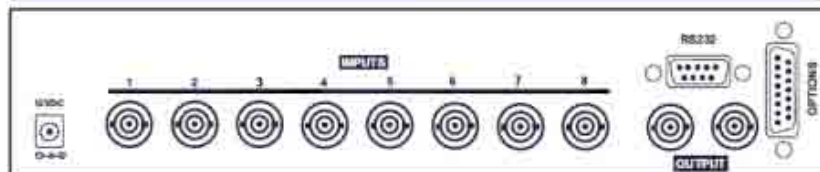
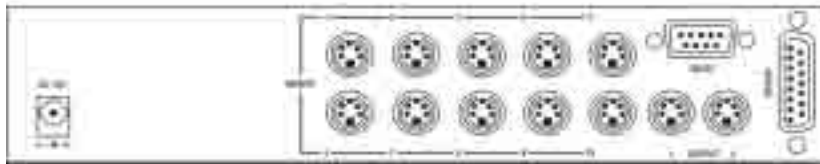
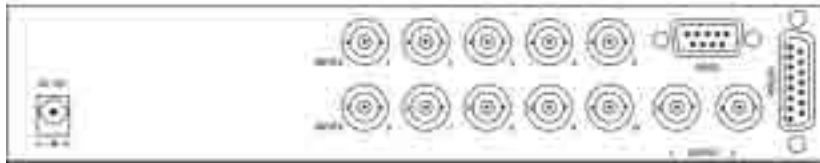
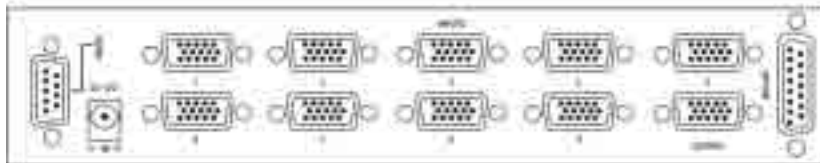
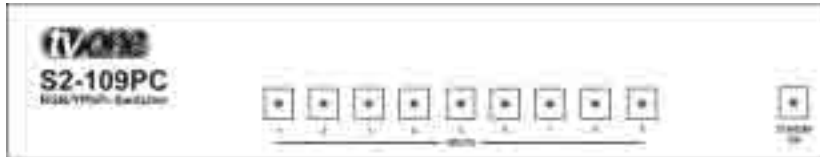
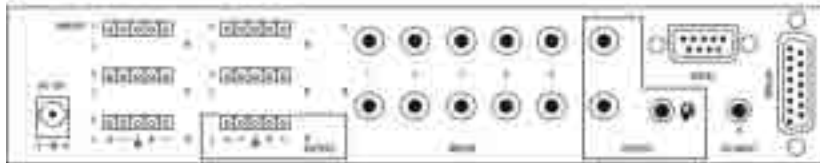

## 5 S2-105PC, S2-105PCA, S2-109PC

The S2-105PC switcher is an RGBHV video switching unit with 5 inputs going to one output. The S2-105PCA is similar to the S2-105PC but with additional audio switching support. The S2-109PC has 9 inputs without audio.

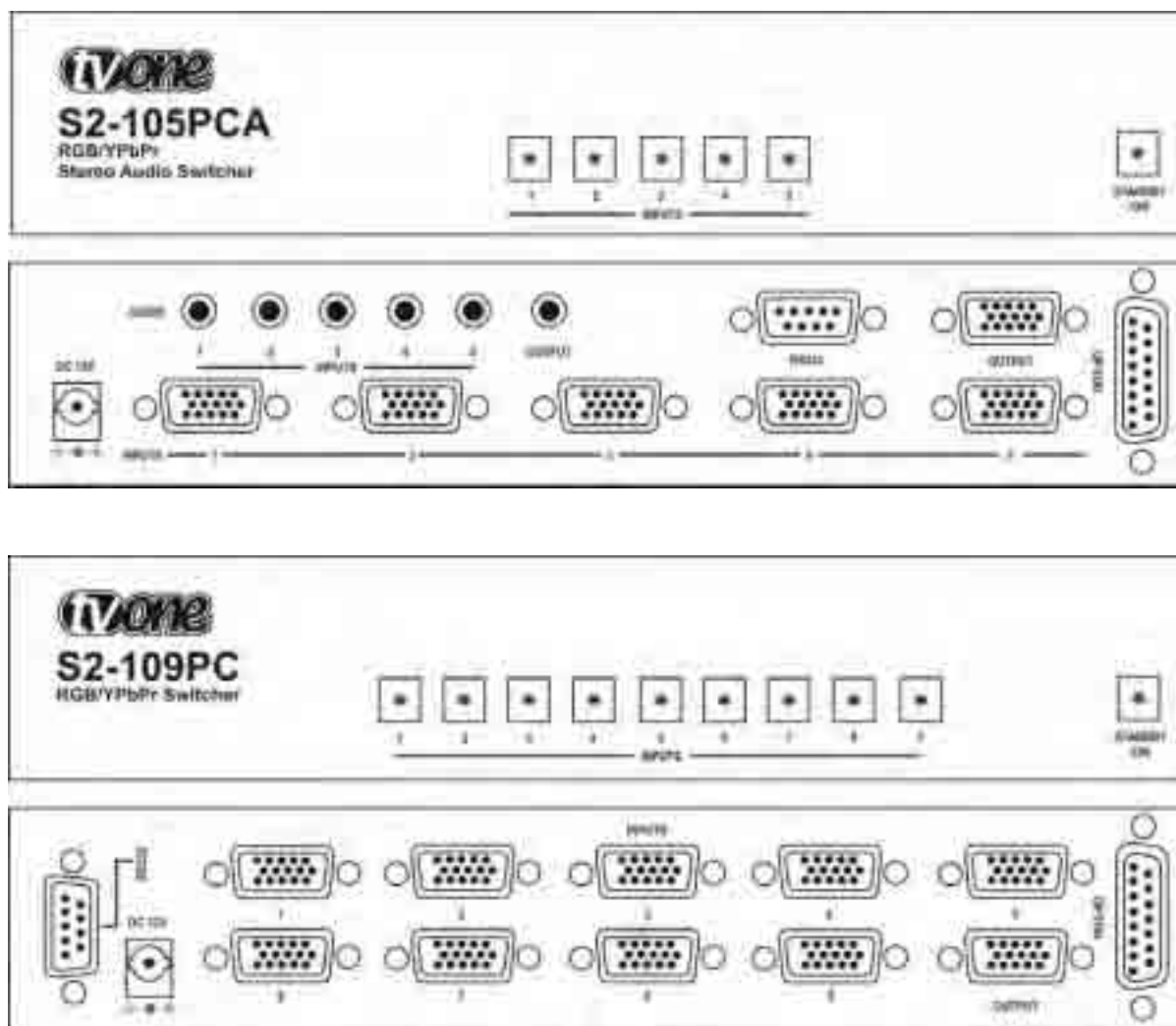

### 5.1 Video/Audio inputs and outputs

Visible in the images, the units have:

- 5 HD15 RGBHV inputs (S2-105PC/A)
- 9 HD15 RGBHV inputs (S2-109PC)
- 1 HD15 RGBHV output
- 5 audio inputs with 3.5mm jack socket (S2-105PCA only)
- 1 audio output with 3.5mm jack socket (S2-105PCA only)

Each input supports:

- Up to UXGA (1600x1200 @ 60Hz) RGB with separate H & V syncs
- RGsB, RGsB & YPbPr signals with composite sync
- EDID pass-through from selected input to output





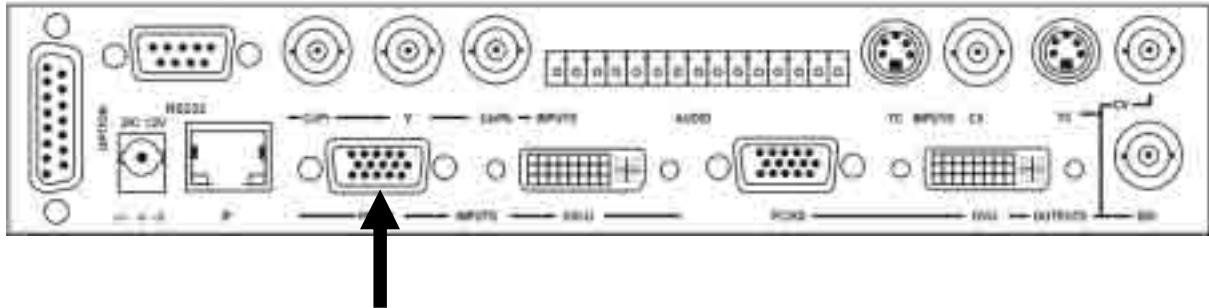

This way, in the case of an S2-105PC, selecting S2-PC1 to S2-PC5 on the scaler will route inputs 1 to 5 on the switcher through to the C2 unit

Please also refer to the 'OPTION cable control for multiple units' section for more information.

### 5.6 Remote control

Your unit comes fitted with infra-red control capability, however infra-red controllers are not shipped with the S2 switcher range as standard.

Please refer to the 'Infra-red remote control' section for more information.

### 5.7 Locking out the IR remote control

When powered up, your S2 unit will be responsive to a remote control handset by default. The responsiveness of the S2 unit can be disabled simply by pressing source selection button 1 simultaneously with the standby button. When both buttons are released, the panel buttons will flash twice and the unit will no longer respond to an infra-red handset.

To re-enable responsiveness, press both buttons again, the buttons will then flash once and the unit will again respond to handset commands.

### 5.8 S2-105PCA extra features

The S2-105PCA unit has additional audio switching support. Selection of video inputs 1 through 5 will automatically select audio inputs 1 through 5 respectively.

When the unit is in standby, the audio outputs will mute as well as the video outputs.

## 6 S2-105CV, S2-105CVA & S2-110CV

The S2-105CV switcher is a composite video switching unit with 5 inputs going to one output. The S2-105CVA is similar to the S2-105CV but with additional audio switching support. The S2-110CV has 10 inputs without audio.

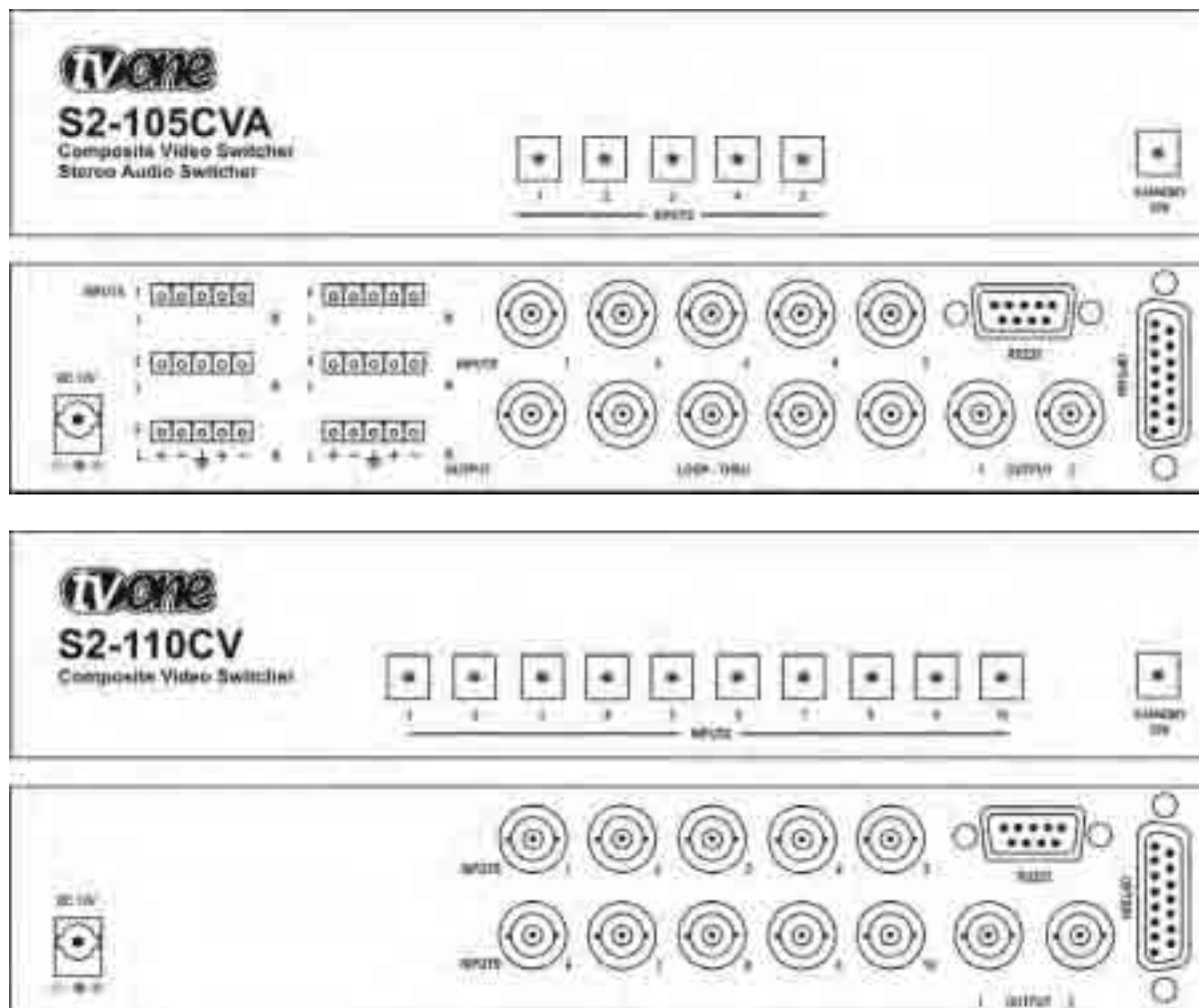

### 6.1 Video/Audio inputs and outputs

Visible in the images, the units have:

- 5 BNC composite video inputs (S2-105CV/A)
- 10 BNC composite video inputs (S2-110CV)
- 5 BNC composite video loop-thru outputs (S2-105CV/A)
- 2 BNC composite video outputs
- 5 audio inputs with mini-combicon connectors (S2-105CVA only)
- 1 audio output with mini-combicon connector (S2-105CVA only)

Each input supports:

- Video format independent routing (PAL NTSC etc)
- Switchable manual on, off or auto-terminations

## 6.2 Front panel buttons

The following buttons are available on the front of the unit:

Button	Button Function
INPUT (n)	Selects an input as the current source. The active source will have its LED lit. If this button is held in for longer than 3 seconds the video termination will alter state. See section 6.2.1 for more details.
STANDBY /ON	Press and hold for 3 seconds to put the unit into Standby (power-save) mode – the LED will be red, and outputs will be blanked. Press again to come out of Standby mode (button lamps will flash once).

### 6.2.1 Auto and manual termination

The S2-105CV and S2-105CVA switchers offer fully automatic individual terminations on each input. However, if you should wish to manually switch the terminations on or off, you can do so by the front panel.

When set to Auto-termination, the input will terminate when no external termination is connected to the loop-through output. A monitor or other video equipment connected to the loop-through output will usually terminate the line, and so the S2 termination should be set to OFF or Auto in this case.

To alter the termination setting for a particular input, press and hold the relevant input select button for more than 3 seconds. The unit will beep and the buttons will flash to indicate the status according to the following table:

Indication	Termination status
1 beep & 1 flash	Termination ON
2 beeps & 2 flashes	Termination OFF
3 beeps & 3 flashes	Auto-termination

The status of the terminations for each input is retained when power to the unit is removed and reapplied.

## 6.3 Default settings

When your unit powers up for the first time, source 1 will be routed by default (unless you are connected to a C2 unit that defaults to a different source). On subsequent power-ups the unit will default to the last source selected by the user.

The default status of the terminations for each input is Auto-terminated.

## 6.4 'Windows<sup>®</sup> Control Panel' control

Your unit comes with support for control via RS-232 using the Windows<sup>®</sup> Control Panel which is available for download from our Internet site, and affords complete control of the unit.

Please refer to the 'RS232 control' section for more information.

### 6.5 OPTION cable control

The S2 series of switchers have been designed to support networked control in conjunction with C2-1000 or C2-2000 series units when connected via an OPTION cable provided with the switcher.

When you connect your unit to a C2 unit via an OPTION cable, the video source menu on the C2 unit will expand to reflect the extra inputs available on the switcher. A single OPTION cable connecting the unit to a C2 unit will provide power to the unit without the need for a separate power supply.

If you are connecting your unit to a C2-1000 or a C2-2000 series video processor, you must connect your unit's video output to the video connector with the highest number as shown in the following diagrams for the C2-1000 & C2-2000:

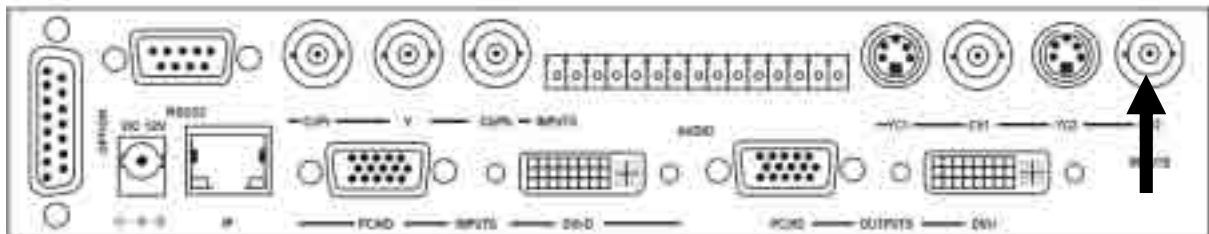

If your C2 unit has only one composite input then connect it to this input as shown:

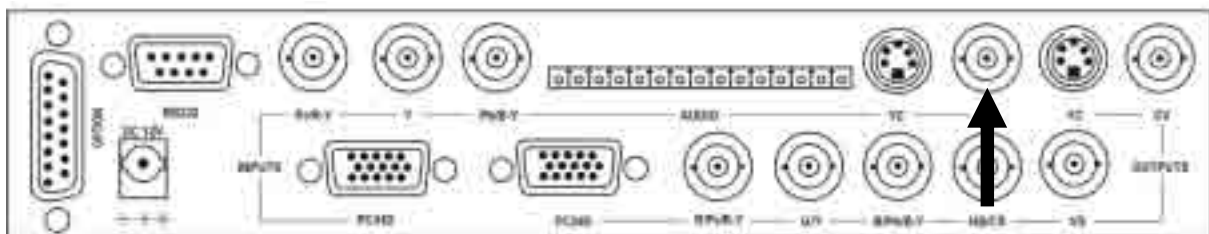

This way the, in the case of an S2-105CV, selecting S2-CV1 to S2-CV5 on the scaler will route inputs 1 to 5 on the switcher through to the C2 unit

Please refer to the 'OPTION cable control for multiple units' section for more information.

### 6.6 Remote control

Your unit comes fitted with infra-red control capability, however infra-red controllers are not shipped with the S2 switcher range as standard.

Please refer to the 'Infra-red remote control' section for more information.

## **6.7 Locking out the IR remote control**

When powered up, your S2 unit will be responsive to a remote control handset by default. The responsiveness of the S2 unit can be disabled simply by pressing source selection button 1 simultaneously with the standby button. When both buttons are released, the panel buttons will flash twice and the unit will no longer respond to an infra-red handset.

To re-enable responsiveness, press both buttons again, the buttons will then flash once and the unit will again respond to handset commands.

## **6.8 S2-105CVA extra features**

The S2-105CVA unit has additional audio switching support. Selection of video inputs 1 through 5 will automatically select audio inputs 1 through 5 respectively.

When the unit is in standby, the audio outputs will mute as well as the video outputs.

## 7 S2-105YC, S2-105YCA & S2-110YC

The S2-105YC switcher is a YC video switching unit with 5 inputs going to one output. The S2-105YCA is similar to the S2-105YC but with additional audio switching support. The S2-110YC has 10 inputs without audio.

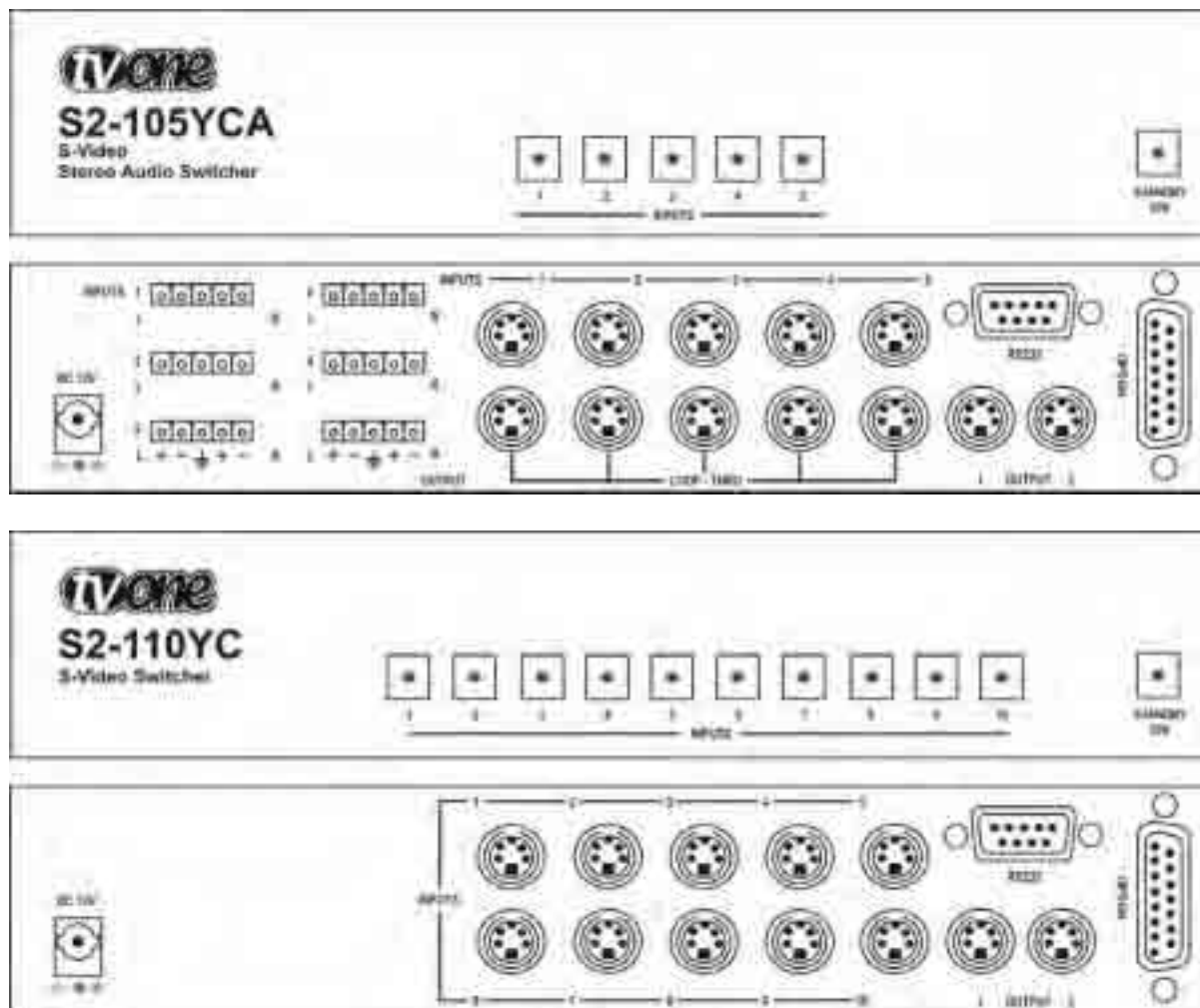

### 7.1 Video/Audio inputs and outputs

Visible in the images, the units have:

- 5 S-Video component video inputs (S2-105YC/A)
- 10 S-Video component video inputs (S2-110YC)
- 5 S-Video component video loop-thru outputs (S2-105YC/A)
- 2 S-Video component video outputs
- 5 audio inputs with mini-combicon connectors (S2-105CVA only)
- 1 audio output with mini-combicon connector (S2-105CVA only)

Each input supports:

- Video format independent routing (PAL NTSC etc)
- Switchable manual on, off or auto-terminations

## 7.2 Front panel buttons

The following buttons are available on the front of the unit:

Button	Button Function
INPUT (n)	Selects an input as the current source. The active source will have its LED lit. If this button is held in for longer than 3 seconds the video termination will alter state. See section 7.2.1 for more details.
STANDBY /ON	Press and hold for 3 seconds to put the unit into Standby (power-save) mode – the LED will be red, and outputs will be blanked. Press again to come out of Standby mode (button lamps will flash once).

### 7.2.1 Auto and manual termination

The S2-105YC and S2-105YCA switchers offer fully automatic individual terminations on each input. However, if you should wish to manually switch the terminations on or off, you can do so by the front panel.

When set to Auto-termination, the input will terminate when no external termination is connected to the loop-through output. A monitor or other video equipment connected to the loop-through output will usually terminate the line, and so the S2 termination should be set to OFF or Auto in this case.

To alter the termination setting for a particular input, press and hold the relevant input select button for more than 3 seconds. The unit will beep and the buttons will flash to indicate the status according to the following table:

Indication	Termination status
1 beep & 1 flash	Termination ON
2 beeps & 2 flashes	Termination OFF
3 beeps & 3 flashes	Auto-termination

The status of the terminations for each input is retained when power to the unit is removed and reapplied.

### 7.3 Default settings

When your unit powers up for the first time, source 1 will be routed by default (unless you are connected to a C2 unit that defaults to a different source). On subsequent power-ups the unit will default to the last source selected by the user.

The default status of the terminations for each input is Auto-terminated.

### 7.4 'Windows® Control Panel' control

Your unit comes with support for control via RS-232 using the Windows® Control Panel which is available for download from our Internet site, and affords complete control of the unit.

Please refer to the 'RS232 control' section for more information.

### 7.5 OPTION cable control

The S2 series of switchers have been designed to support networked control in conjunction with C2-1000 or C2-2000 series units when connected via an OPTION cable provided with the switcher.

When you connect your unit to a C2 unit via an OPTION cable, the video source menu on the C2 unit will expand to reflect the extra inputs available on the switcher. A single OPTION cable connecting the unit to a C2 unit will provide power to the unit without the need for a separate power supply.

If you are connecting your unit to a C2-1000 or a C2-2000 series video processor, you must connect your unit's video output to the video connector with the highest number as shown in the following diagrams for the C2-1000 & C2-2000:

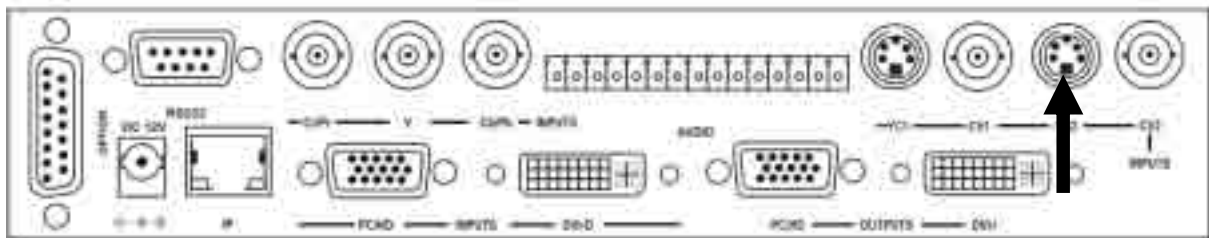

If your C2 unit has only one YC input then connect it to this input as shown:

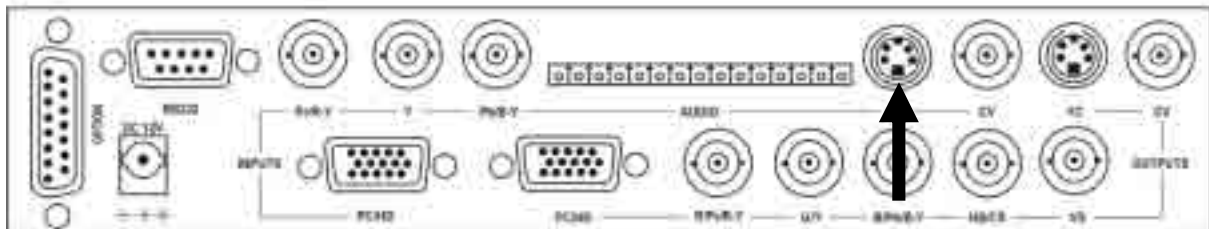

In the case of an S2-105YC, selecting S2-YC1 to S2-YC5 on the scaler will now route inputs 1 to 5 on the switcher through to the C2 unit.

Please refer to the 'OPTION cable control for multiple units' section for more information.

### 7.6 Remote control

Your unit comes fitted with infra-red control capability, however infra-red controllers are not shipped with the S2 switcher range as standard.

Please refer to the 'Infra-red remote control' section for more information.

### 7.7 Locking out the IR remote control

When powered up, your S2 unit will be responsive to a remote control handset by default. The responsiveness of the S2 unit can be disabled simply by pressing



source selection button 1 simultaneously with the standby button. When both buttons are released, the panel buttons will flash twice and the unit will no longer respond to an infra-red handset.

To re-enable responsiveness, press both buttons again, the buttons will then flash once and the unit will again respond to handset commands.

### **7.8 S2-105YCA extra features**

The S2-105YCA unit has additional audio switching support. Selection of video inputs 1 through 5 will automatically select audio inputs 1 through 5 respectively.

When the unit is in standby, the audio outputs will mute as well as the video outputs.

## 8 S2-105DVIA

The S2-105DVIA switcher is a DVI-D video switching unit with 5 DVI-D inputs going to one output as well as additional audio switching support.

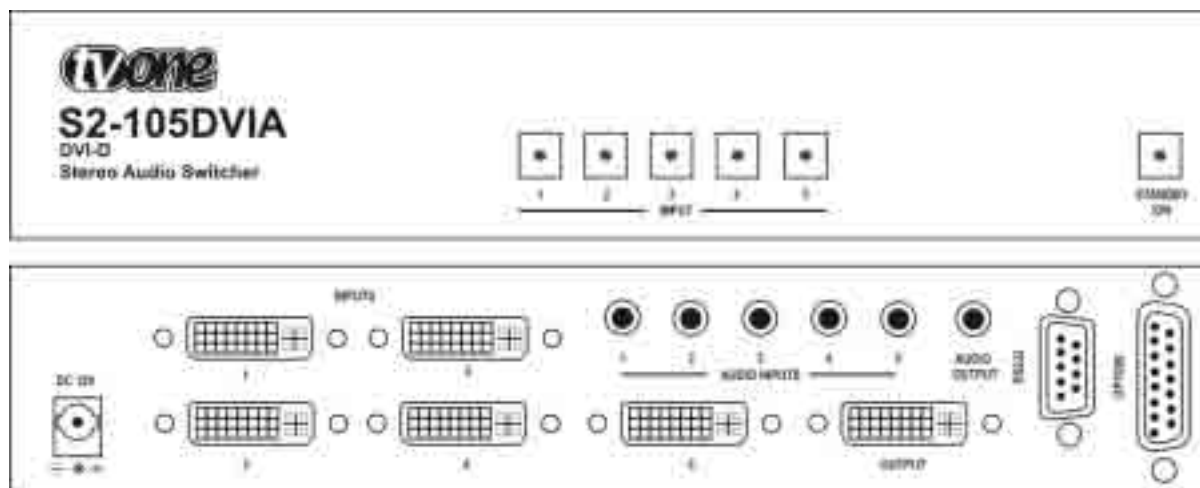

### 8.1 Video/Audio inputs and outputs

Visible in the images, the units have:

- 5 DVI-D video inputs
- 1 DVI-D video output
- 5 audio inputs with 3.5mm jack socket
- 1 audio output with 3.5mm jack socket

Each input supports:

- DVI-D video format
- HDCP compliant and HDMI compatible
- Compatible to EDID version 1.3
- 1600x1200@60Hz and 1920x1080p@60Hz resolution
- 1.65 GHz bandwidth

### 8.2 Front panel buttons

The following buttons are available on the front of the unit:

Button	Button Function
INPUT (n)	Selects an input as the current source. The active source will have its LED lit.
STANDBY /ON	Press and hold for 3 seconds to put the unit into Standby (power-save) mode – the LED will be red, and outputs will be blanked. Press again to come out of Standby mode (button lamps will flash once).

### 8.3 Default settings

When your unit powers up for the first time, source 1 will be routed by default (unless you are connected to a C2 unit that defaults to a different source). On subsequent power-ups the unit will default to the last source selected by the user.

### 8.4 'Windows® Control Panel' control

Your unit comes with support for control via RS-232 using the Windows® Control Panel which is available for download from our Internet site, and affords complete control of the unit.

Please refer to the 'RS232 control' section for more information.

### 8.5 OPTION cable control

The S2 series of switchers have been designed to support networked control in conjunction with C2-1000 or C2-2000 series units when connected via an OPTION cable provided with the switcher.

When you connect your unit to a C2 unit via an OPTION cable, the video source menu on the C2 unit will expand to reflect the extra inputs available on the switcher.



*Note that unlike the other S2 switchers, the S2-105DVIA can not be powered directly from a C2 unit via an option cable, and that a separate 12V 1A power supply must be used instead.*

If you are connecting your unit to a C2-2000 series video processor, you must connect your unit's video output to the DVI-D IN video connector as shown:

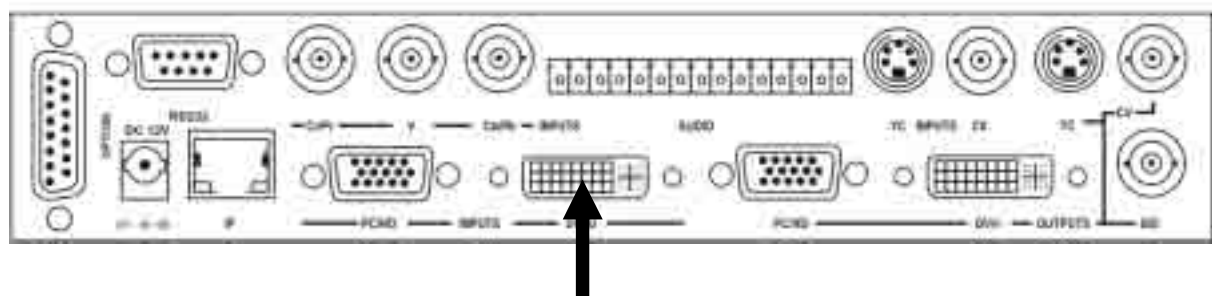

This way, selecting S2-DVI1 to S2-DVI5 on the scaler will route inputs 1 to 5 on the switcher through to the C2 unit.

Please refer to the 'OPTION cable control for multiple units' section for more information.

### 8.6 Remote control

Your unit comes fitted with infra-red control capability, however infra-red controllers are not shipped with the S2 switcher range as standard.

Please refer to the 'Infra-red remote control' section for more information.

### **8.7 Locking out the IR remote control**

When powered up, your S2 unit will be responsive to a remote control handset by default. The responsiveness of the S2 unit can be disabled simply by pressing source selection button 1 simultaneously with the standby button. When both buttons are released, the panel buttons will flash twice and the unit will no longer respond to an infra-red handset.

To re-enable responsiveness, press both buttons again, the buttons will then flash once and the unit will again respond to handset commands.

### **8.8 S2-105DVIA extra features**

The S2-105DVIA unit has additional audio switching support. Selection of video inputs 1 through 5 will automatically select audio inputs 1 through 5 respectively.

When the unit is in standby, the audio outputs will mute as well as the video outputs.

## 9 S2-101AA

The S2-101AA is an audio power amplifier giving at least 10 Watts per channel into 4 ohm speakers from pre-amplified signal levels.

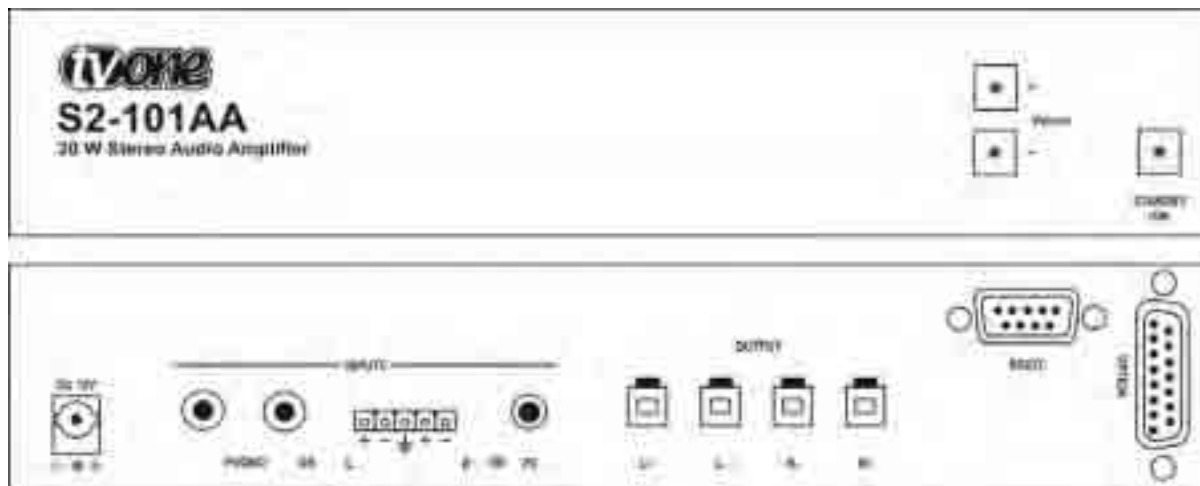

### 9.1 Audio inputs and outputs

Visible in the images, the units have:

- Left and Right channel RCA (phono) differential inputs
- Left and Right differential inputs with mini-combicon connector
- Stereo single ended PC input with 3.5mm jack socket
- Speaker outputs with spring lock connector

The S2-101AA supports:

- 10 Watts per channel output power
- Front panel and remote control volume setting
- On-off-mute pop suppression to protect speakers
- Audio amplifier short circuit and over-temperature protection

### 9.2 Front panel buttons

The following buttons are available on the front of the unit:

Button	Button Function
Volume	Adjusts the output level in relation to the input.
STANDBY /ON	Press and hold for 3 seconds to put the unit into Standby (power-save) mode, with the LED turning red. Press again to come out of Standby mode (button lamps will flash once). Whilst in standby, the audio outputs will mute.

### 9.3 Default settings

When your unit powers up for the first time, the volume level will be set to mid way. On subsequent power-ups the unit will default to the last volume level selected by the user.

## 9.4 'Windows® Control Panel' control

Your unit comes with support for control via RS-232 using the Windows® Control Panel which is available for download from our Internet site, and provides volume control for the unit.

Please refer to the 'RS232 control' section for more information.

## 9.5 OPTION cable control

The S2 series of switchers have been designed to support control in conjunction with C2-1000, C2-2000 or C2-7000 series units when connected via an OPTION cable provided with the switcher.

When you connect your unit to a C2 unit via an OPTION cable, the 'Adjust Outputs' menu will expand to show the 'Audio amp. volume' menu for adjusting the volume from the C2 unit.



*Note that unlike the other S2 units, the S2-101AA can not be powered directly from a C2 unit via an option cable, and that a separate 12V power supply must be used instead. Please refer to the 'Specifications' section for more information.*

## 9.6 Remote control

Your unit comes fitted with infra-red control capability, however infra-red controllers are not shipped with the S2 switcher range as standard.

Please refer to the 'Infra-red remote control' section for more information.

## 9.7 Locking out the IR remote control

When powered up, your S2 unit will be responsive to a remote control handset by default. The responsiveness of the S2 unit can be disabled simply by pressing Volume+ button simultaneously with the standby button. When both buttons are released, the panel buttons will flash twice and the unit will no longer respond to an infra-red handset.

To re-enable responsiveness, press both buttons again, the buttons will then flash once and the unit will again respond to handset commands.

## 9.8 S2-101AA extra features

Whilst the unit is in standby, the outputs will mute.

The unit has a soft start volume feature designed to remove sudden jumps to high volume levels when the unit is switched on, causing possible damage to speakers.

## 10 S2-106AD

The S2-106AD is a stereo audio switching unit with a dual output selected from six separate inputs.

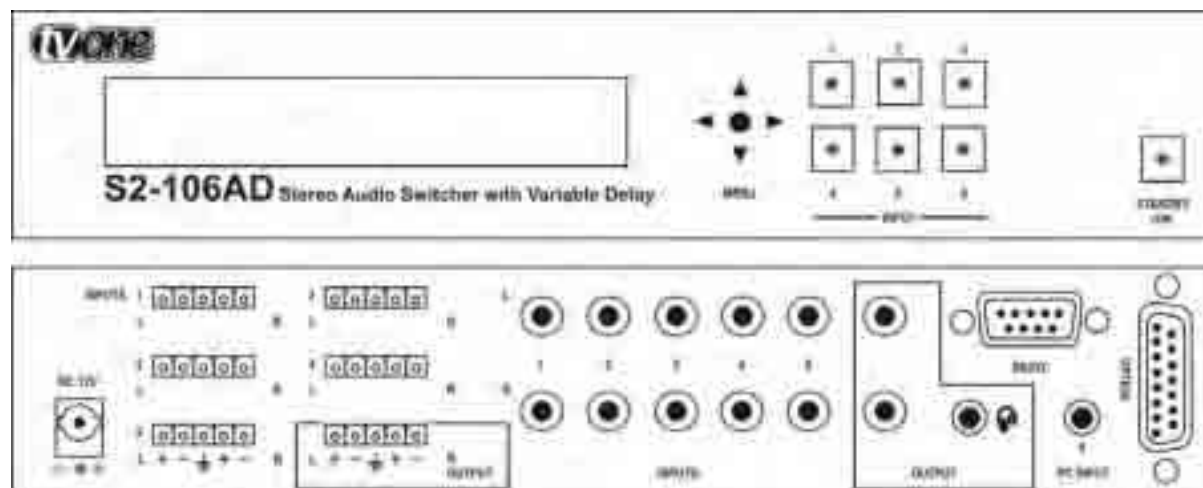

The S2-106AD supports separate control for Volume, Balance, Sampling frequency and Audio delay for each input, plus headphone volume.

### 10.1 Audio inputs and outputs

Visible in the photograph, the S2-106AD has:

- 5 balanced inputs with connector blocks
- 1 balanced output with connector block
- 5 single ended left & right RCA inputs
- 1 left & right RCA output
- 1 headphone output with 3.5mm jack socket
- A sixth single ended PC input with 3.5mm jack socket

Each input supports variable audio delay for lip sync control, with optional sampling frequencies varying between:

- For sampling rate 32kHz 0 to 999ms delay
- For sampling rate 44.1kHz 0 to 740ms delay
- For sampling rate 48kHz 0 to 680ms delay
- For sampling rate 96kHz 0 to 340ms delay

## 10.2 Front panel buttons

The following buttons are available on the front of the unit:

Button	Button Function
INPUT 1-6	Selects an audio input as the current source (if connected to a C2 unit, these buttons have no effect and the audio source selection is under control of the C2 unit in the 'Adjust sources' menu)
STANDBY /ON	Press and hold for 3 seconds to put the unit into Standby (power-save) mode, with the LED turning red. Press again to come out of Standby mode (button lamps will flash once). Whilst in standby, the audio outputs will mute.

### 10.2.1 Multi-directional switch

The LCD is controlled from the front panel using the multi-directional switch (m/d switch). This switch can be moved left, right, up or down and also pressed in. These functions let the user navigate through the menu structure or change a parameter, and are detailed in a later section.

When adjusting audio delay for instance, a single nudge and release of the m/d switch will adjust the value by one, holding it for 1 to 3 seconds will rapidly adjust it in single steps, and over 4 seconds will rapidly adjust in steps of 10, so that your desired value can be quickly set.

## 10.3 Default settings

When your unit powers up for the first time, source 1 will be routed by default. On subsequent power-ups the unit will default to the last source selected by the user.

## 10.4 'Windows® Control Panel' control

Your unit comes with support for control via RS-232 using the Windows® Control Panel which is available for download from our Internet site, and affords complete control of the unit.

Please refer to the 'RS232 control' section for more information.

## 10.5 OPTION cable control

The S2 series of switchers have been designed to be controlled by a C2-1000, C2-2000 or C2-7000 series unit when connected via an OPTION cable provided with the switcher.

When you connect your unit to a C2 unit via an OPTION cable, the 'Audio source' menu on the C2 unit will expand to reflect the extra inputs available on the switcher.



A single OPTION cable connecting the unit to a C2 unit will provide power to the unit without the use of a separate power supply.

The input can then be selected via the C2 unit only in the 'Adjust sources' menu, by assigning each audio source to a video source in the C2 unit.

Please refer to the 'OPTION cable control for multiple units' section or the C2-1000 C2-2000 or C2-7000 series manual for more information.

## **10.6 Remote control**

Your unit comes fitted with infra-red control capability, however infra-red controllers are not shipped with the S2 switcher range as standard.

Please refer to the 'Infra-red remote control' section for more information.

## **10.7 Locking out the IR remote control**

When first powered up, your S2 unit will be responsive to a remote control handset by default. The responsiveness of the S2 unit can be disabled simply by pressing source selection button 1 simultaneously with the standby button. When both buttons are released, the panel buttons will flash twice and the unit will no longer respond to an infra-red handset.

To re-enable responsiveness, press both buttons again, the buttons will then flash once and the unit will again respond to handset commands.

## **10.8 Menu layout and settings adjustment**

Here we'll be looking at the menu structure employed in the S2-106AD and, more importantly, the individual menu items that allow you to take advantage of the power of the unit.

You'll be using the multi-directional switch and the LCD to view the options and settings available to you. Move the multi-directional switch left or right to see where you are in the menu, and go into the sub menu ('Adjust sources') by pressing the multi-directional switch once. To exit the sub menu, scroll the multi-directional button to the end of the sub menu to reveal 'Exit', and push again.

You can edit a value in brackets '[ ]' by pressing the multi-directional switch once (you'll note that the brackets surrounding a particular parameter's value will begin to flash). Change the value by moving the switch left or right or up and down. Then finalize your adjustment by pressing the multi-directional switch once more.

Holding the multi-directional switch left, right, up or down for a short time will keep adjusting the relevant value, therefore allowing fast changes to a setting – which is very useful for the audio delay setting.

## 10.9 The Menu Structure

The figure below shows the structure of the menu system at a glance, and that the menu has only one sub-menu for adjusting the source parameters.

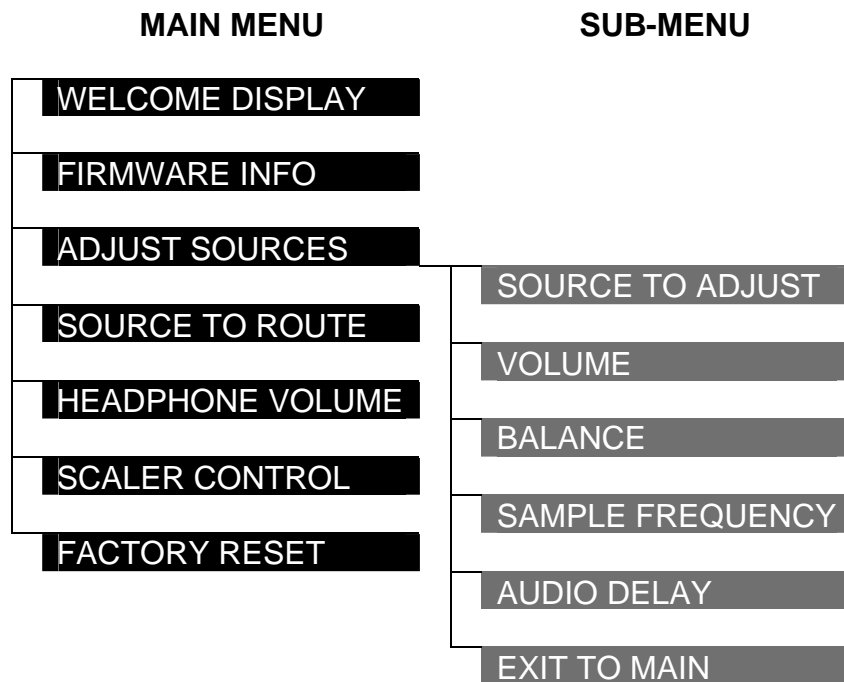

Menu screens are arranged so that a particular general function has a menu name on the top line, and beneath that either a sub-menu, or a related setting is displayed. In the sub menu, the top line may display the source to adjust.

## 10.10 Settings



*Some menu items cannot be adjusted via the controls on your unit whilst it is connected to a C2 unit via an OPTION cable (unless the scaler control screen shows 'NO').*

When your unit is under control of the C2 unit, the parameters in your unit are determined by the settings in the C2 unit. Whilst connected, the user can select an audio input for use with each video source (which can be one of your S2-106AD audio inputs) and adjustments can be made to the volume, balance, sampling frequency and delay for each audio input using the front panel on the C2 unit.

The following table lists those parameters under control of the C2 unit, and explains which factors determine their values:

Parameter:	Determined by:
Source to route	The audio source assigned to the currently selected video input on the C2 unit
Headphone volume	The C2 units headphone volume setting
Source to adjust	The audio source assigned to the currently selected video input in the C2 unit
Volume	The volume setting of the audio source assigned to the currently selected video input in the C2 unit
Balance	The balance setting of the audio source assigned to the currently selected video input in the C2 unit
Sampling frequency	The sampling frequency setting of the audio source assigned to the currently selected video input in the C2 unit
Audio delay	The audio delay setting of the audio source assigned to the currently selected video input in the C2 unit

### 10.11 Menu description

There are two screens that appear before the sub-menu is accessed:

TV One S2-106AD
--------------------

The first is the 'welcome' display shown above indicating the model of the unit.

www.tvone.com SW: 1. PT: 56, BT: 41
--

Moving to the next menu item displays the firmware information screen (the numbers on your unit may be different to those shown). The SW number refers to the version of firmware loaded into the unit, this can be upgraded from the support website:

<http://www.tvone.com/support>

The PT and BT numbers refer to Hardware version information and are of interest to the Technical Support Group should you ever need assistance.

Sub menu... Adjust sources
-------------------------------

Pressing the multi directional switch once will display the sub menu enabling adjustment of volume, balance, sampling frequency and audio delay for each source.

Source Select Source to route [ 1]
---------------------------------------

Use this item to select which audio input source to route through to the output. The S2-106AD has six inputs. When a source is selected, the menu automatically jumps to show the volume screen for that source.

Headphone Volume Volume [ 5]
---------------------------------

This menu item adjusts the audio headphone volume for the headphone output. The reading is in decibels from -16 (mute) to +15. Note that the headphone level is added to the specific source volume level, so if the headphone volume level is 5 and the volume level is 2 then the level at the headphone output will actually be 7 decibels.

Scaler control Push to select [YES]
--

This menu item is only relevant when your unit is connected to a C2 unit via an OPTION cable, and it can be used to disable control by the C2 unit so that you can use the controls on your S2 unit. Please refer to the OPTION cable control section for more information.

Factory Reset Push to reset
--------------------------------

Use this screen if you wish to restore all operational parameters to their original condition. Pressing the multi directional switch will display a second verification screen where you can select 'NO' to cancel or 'YES' to restore the factory settings.



*All stored settings (including source, volume, balance, sampling frequency, delay & headphone volume) are lost when the unit is reset.*

Adjust sources Source to adjust [ 1]
---

This sub-menu item selects the input source for which you want to make adjustments to. As in the image above, changes will only be made to the source connected to input 1. Once the selection has been made, all changes made using the following operating parameters will only apply to the selected input, which will be displayed in the top line of the display.

Source: 1 Volume [ 1]
--------------------------

This menu item adjusts the audio volume for the selected audio channel. The reading is in decibels from -16 (mute) to +15.

Source: 1 Balance [ 0]
---------------------------

This menu item adjusts the audio balance for the selected audio channel. The reading is in decibels from -15 (fully left) to +15 (fully right).

Source: 1 Sample frequency [ 96]
-------------------------------------

This menu item adjusts the sampling frequency for the selected audio channel. The reading is in kHz (kilohertz) and five settings are available, 'bypass' (digital audio path is internally bypassed), 32kHz, 44.1kHz, 48kHz and 96kHz.

Source: 1 Audio delay [ 999 ]
----------------------------------

This menu item adjusts the digital audio delay for the selected audio channel. The reading is in milliseconds and the maximum delay is limited by the sampling frequency setting as shown in the table below.

Sampling frequency (kHz)	Maximum delay (ms)
bypass	No delay
32	999
44.1	740
48	680
96	340

To adjust the delay by a large amount, hold the multi-directional switch in the desired direction, and after four seconds the delay will change rapidly.

Adjust sources Exit
------------------------

Use this menu item to exit the sub-menu and go back to the main menu.

## 11 S2-108HD

The S2-108HD switcher is an HD-SDI and SD-SDI switching unit with 8 inputs going to two identical outputs. The unit automatically detects the input signal rate and re-clocks the signal to the appropriate frequency, in addition to restoring the signal to the correct level. Visual confirmation of signal lock is shown in the status of the selected channel indicator.

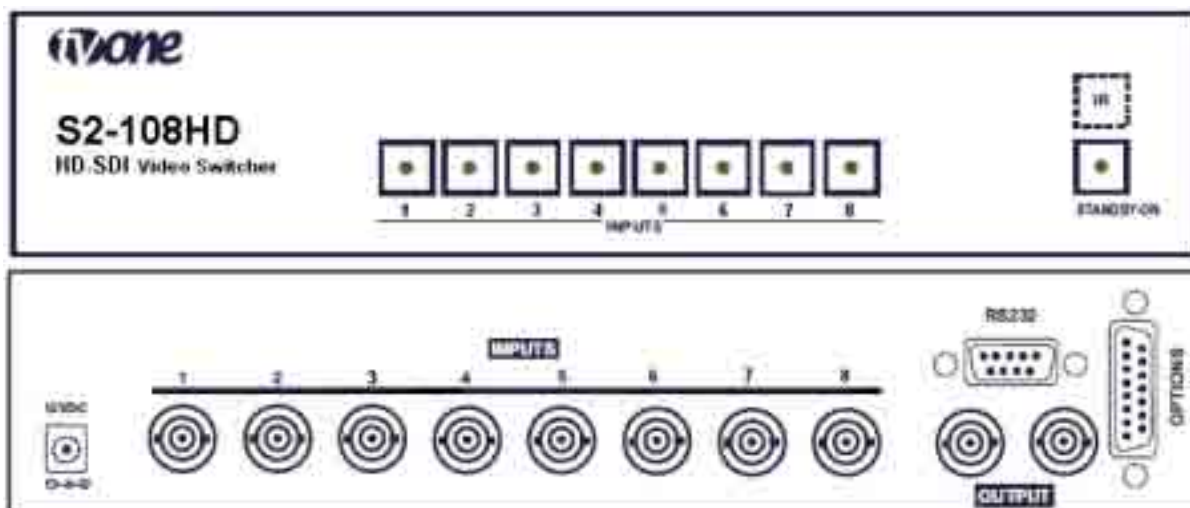

### 11.1 Video/Audio inputs and outputs

Visible in the images, the unit has:

- 8 HD-SDI video inputs
- 2 identical HD-SDI video outputs (both re-clocked and equalized)

Each input supports:

- SDI and HD-SDI (compliant to SMPTE 259M and 292M)

### 11.2 Front panel buttons

The following buttons are available on the front of the unit:

Button	Button Function
INPUT (n)	Selects an input as the current source. The active source will have its LED lit. See section 11.2.1 for more details.
STANDBY /ON	Press and hold for 3 seconds to put the unit into Standby (power-save) mode – the LED will be red, and outputs will be blanked. Press again to come out of Standby mode (button lamps will flash once).

#### 11.2.1 Auto Operation

The S2-108HD switcher automatically equalizes and re-clocks the selected port signal to the correct SMPTE 292M and 259M levels. Should a non-compliant input

be connected to the selected port the signal will not be re-clocked but will be switched through to the outputs. This will be indicated by Loss of Lock indication.

The unit will display the lock status of the currently selected input on the corresponding button LED. It will either flash to indicate ‘Loss of Lock Detection’ or remain permanently on to indicate ‘Signal Lock’. The status is summarized in the following table:

Indication	Signal Lock status
Flashing	No Re-clocker Lock
On	Re-clocker Locked

### 11.3 Default settings

When your unit powers up for the first time, source 1 will be routed by default (unless you are connected to a C2 unit that defaults to a different source). On subsequent power-ups the unit will default to the last source selected by the user.

### 11.4 ‘Windows® Control Panel’ control

Your unit comes with support for control via RS-232 using the Windows® Control Panel which is available for download from our Internet site, and affords complete control of the unit.

Please refer to the ‘RS232 control’ section for more information.

### 11.5 OPTION cable control

The S2 series of switchers have been designed to support networked control in conjunction with C2-1000 or C2-2000 series units when connected via an OPTION cable provided with the switcher.

When you connect your unit to a C2 unit via an OPTION cable, the video source menu on the C2 unit will expand to reflect the extra inputs available on the switcher. A single OPTION cable connecting the unit to a C2 unit will provide power to the unit without the need for a separate power supply.

Specifically within the C2 range of products, the S2-108HD provides HD-SDI input port expansion for the C2-2205 and C2-2255 units.

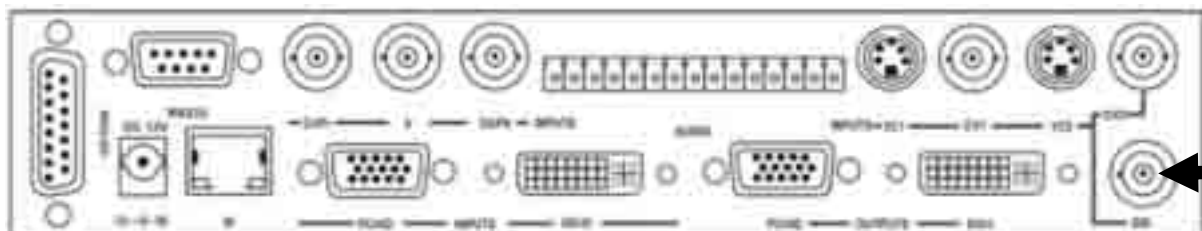

C2-2205 and C2-2255 Rear Panels

Please refer to the ‘OPTION cable control for multiple units’ section for more information.

## **11.6 Remote control**

Your unit comes fitted with infra-red control capability, however infra-red controllers are not shipped with the S2 switcher range as standard.

Please refer to the 'Infra-red remote control' section for more information.

## **11.7 Locking out the IR remote control**

When powered up, your S2 unit will be responsive to a remote control handset by default. The responsiveness of the S2 unit can be disabled simply by pressing source selection button 1 simultaneously with the standby button. When both buttons are released, the panel buttons will flash twice and the unit will no longer respond to an infra-red handset.

To re-enable responsiveness, press both buttons again, the buttons will then flash once and the unit will again respond to handset commands.



## 12 INFRA-RED REMOTE CONTROL

Note: please refer to your specific product section for information on how to lock out the infra-red remote control – for cases where another unit shares the same codes.



*If the unit is connected to a C2 unit, the infra-red control buttons may have no effect and the units settings may be under the control of the C2 unit.*

### 12.1 S2-106AD operation

When operating your unit using a remote control handset, the reset button resets the units internal processor, the channel buttons are used to select the input to route to the outputs (see diagram below for channel numbers) and the up and down, left and right arrows are used to adjust the volume and balance respectively depending on the features available on the model.

### 12.2 S2-101AA operation

When operating your unit using a remote control handset, the up and down arrows are used to adjust the volume of the output.

### 12.3 Video switcher operation

Video switcher input selection buttons as shown – corresponding to a ‘telephone keypad’ on the first 4 full rows of buttons.

Pressing the button associated with an input directly selects that input.

RESET will reset the unit.



### 12.4 Purchasing an infra-red controller

It is recommended that a remote control handset is purchased from TV One as these will readily control any unit in the S2 range. Please contact TV One using the <http://www.tvone.com/support> website for more information.

Alternatively most universal infra-red controllers can be programmed to control any unit in the S2 range. The unit will respond to an NEC code set and it is recommended that when purchasing a handset that you ensure it supports at least one NEC code set.

TV One cannot guarantee that all universal remote controllers that support an NEC code set will support the correct particular NEC code set, however the units were designed to accept a commonly used code. The units have been tested with a “One for all<sup>®</sup>” handset set to NEC 0170 code set.

## 13 OPTION CABLE CONTROL FOR MULTIPLE UNITS

The S2 series of switchers have been designed to support external control using a C2-1000/2000 or (for some units) C2-7000 series scan converters and scalers, when connected via an OPTION cable provided with the S2 switcher.

When any video-switching S2 unit is connected to a C2 unit, the relevant source menu on the C2 unit (according to the video type) will expand to reflect the extra inputs available on the switcher. In the case of an S2-106AD audio switcher, the audio switcher menu becomes available in the 'Adjust sources' menu on the C2 unit, with menu settings for audio input source, volume, balance, frequency and delay. In the case of an S2-101AA audio amplifier, the 'Adjust Outputs' menu will expand to show the 'Audio amp. volume' menu for adjusting the volume from the C2 unit.

### 13.1 OPTION cable connections

Each OPTION cable has a breakout so that more than one OPTION cable can be cascaded to support more than one switcher, with one lead per switcher. The plug with two leads is plugged into the back of the C2 unit, whilst the long lead goes to the first S2 unit.

A second identical OPTION cable can be plugged into the short end of the first to provide for a second S2 unit, and so on up to a recommended maximum of 5 S2 units.

The unit connected directly (through a single lead) to the C2 unit can be powered via the OPTION cable alone, whereas all others will require a separate power supply.

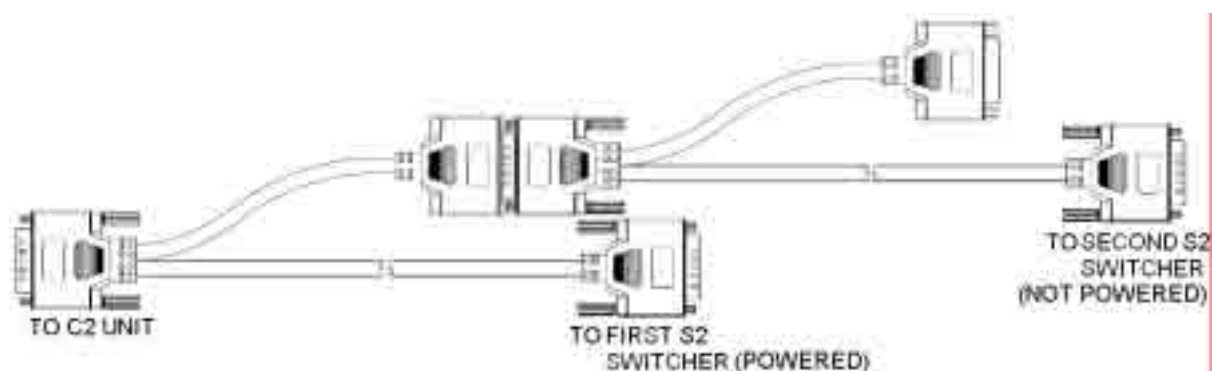

*Please note that the S2-105DVIA and the S2-101AA cannot be powered from a C2 unit via an OPTION cable. These will require external power supplies to operate.*

### 13.2 Audio connections

If you want to connect more than one switcher with audio capabilities (e.g. an S2-105PCA and S2-106AD), then special consideration needs to be given to the way

the audio leads are connected, as some audio connectors are balanced and some are not.

If you have a C2 series unit with audio inputs, you may choose to connect your S2 switcher audio outputs to the audio inputs on your C2 unit and use the C2 unit output as a single system output as in the example diagram.

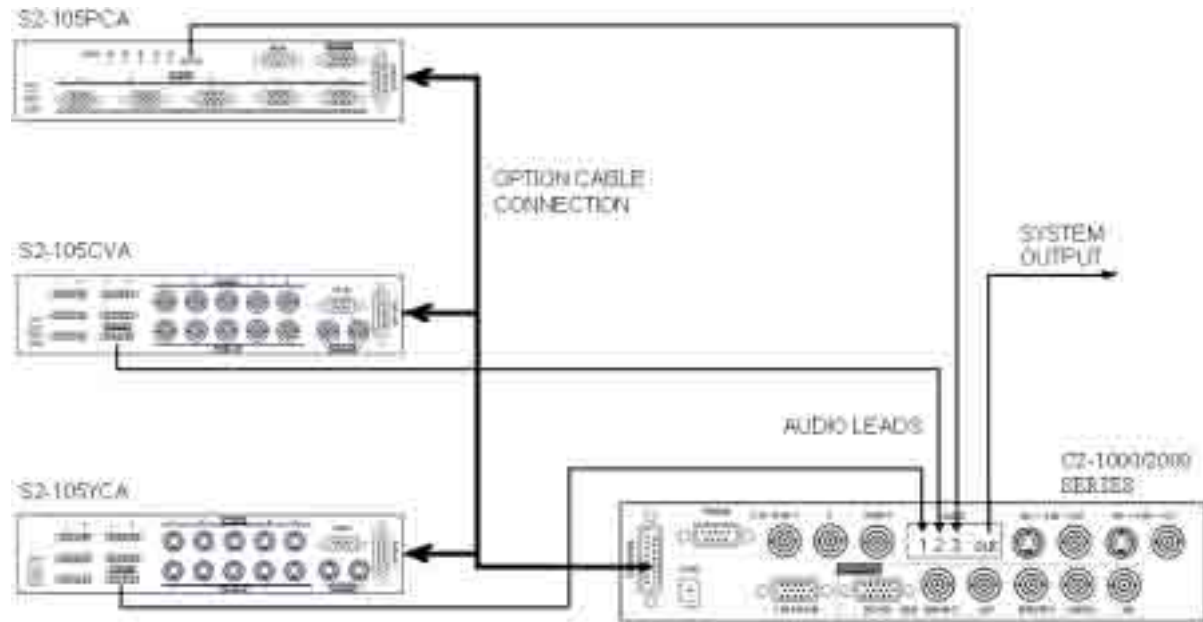

In the example shown, audio input 1 must be assigned to all YC video sources, input 2 to all composite sources and input 3 to all RGB sources in the C2 unit as shown in the table below.

Source to adjust	Audio input	Source to adjust	Audio input
S2-YC1	1	S2-CV4	2
S2-YC2	1	S2-CV5	2
S2-YC3	1	S2-CV6	2
S2-YC4	1	S2-PC1	3
S2-YC5	1	S2-PC2	3
S2-YC6	1	S2-PC3	3
S2-CV1	2	S2-PC4	3
S2-CV2	2	S2-PC5	3
S2-CV3	2	S2-PC6	3

When the user then selects each video input, the correct audio input will be routed automatically.

The assignment of audio inputs to video sources is done from the C2 unit front panel under the 'Adjust sources' group. For example to assign audio input 1 to S2 YC source 1, select S2-YC1 in the 'Source to adjust' screen, then select 1, in the 'Audio input' screen, repeat for S2-YC2, and audio input 1,

On C2 units with audio inputs, the inputs are not balanced, and at the time of writing TV One do not supply audio leads to convert between balanced and unbalanced connectors, however the following wiring diagram shows how this can be done.

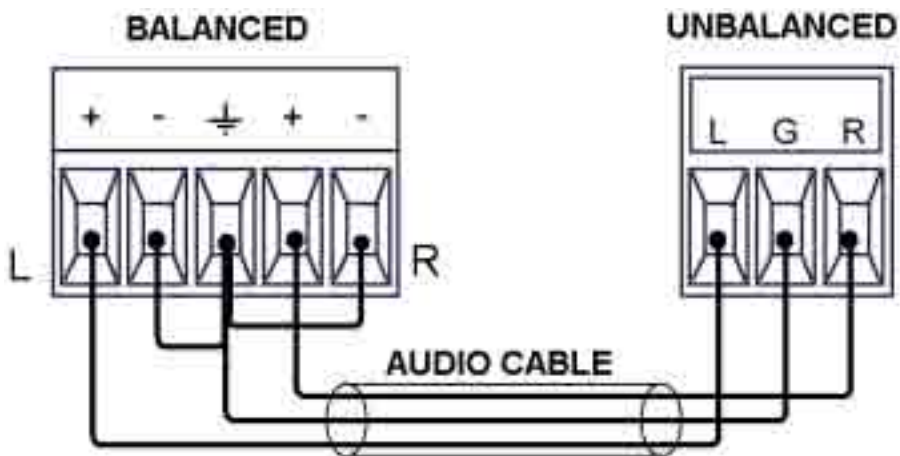

The negative outputs should be connected to ground and the left and right signals are taken from the positive outputs.

An alternative to this system is to use the S2-106AD audio switcher, which offers five balanced inputs and a balanced output, so you can take your switcher audio outputs into the S2-106AD and use its output as your system output, whilst maintaining a fully balanced system.

The following diagram illustrates an example of this arrangement:

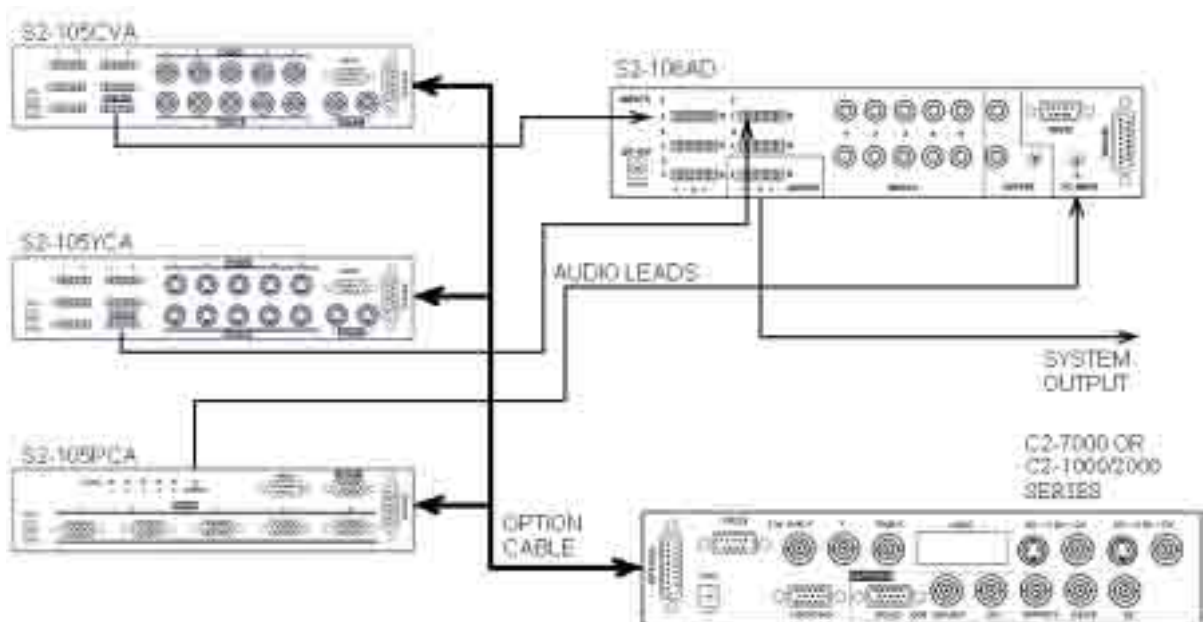

Once all audio leads, video leads and OPTION cables have been connected, you will need to assign the correct audio inputs to video sources in the C2 unit for the audio to automatically switch with the correct video sources.

In the example in the diagram, input 1 of the audio switcher must be assigned to all composite channels, input 2 to all YC channels and input 6 (PC INPUT) to all RGB channels in the C2 unit. When the user then selects each video input, the correct audio input will be routed automatically.

The system output in the diagrams above could be routed to an S2-101AA audio amplifier to drive a pair of speakers for studio monitoring.

### **13.3 OPTION control limitations**

The user should connect a maximum of five S2 units, (or four and one A2-2000), to the OPTION port of a C2-1000/2000 or C2-7000 series unit, and all units (except the first) must be powered in order for the system to work properly.

If your C2 unit has only DVI connectors, either a DVI-D switcher (e.g. S2-105DVIA) or a PCA switcher (e.g. S2-105PCA) can be plugged into it, never both. Both types of switcher will respond to source selection requests from the C2 unit's menu system.

Furthermore, two S2 units of the same video type **MUST NOT** be connected to a C2 unit simultaneously, e.g. an S2-105PC and an S2-105PCA, or two composite video switchers. This would cause contention on the OPTION network and may damage your equipment.

## 14 RS232 CONTROL

### 14.1 Connection

Your unit is fitted with a standard 'D9' socket allowing it to be controlled from a computer or other type of terminal or console with a similar interface. Most computers fitted with an RS232 port, known as a 'COM' port, will have a 'D9' plug on them. To enable connection between the two devices you will require a D9 male to female cable to link from the computer to your unit. This cable is not the same as a 'null-modem' cable as this has a female socket connector on both ends. See the Specifications section for a detailed pin connection list.

Should your PC not have an RS232/COM port, it is possible to add an interface card into the PC to add this facility. Another option you could use is a USB to RS232 converter. Both methods will add a COM port to your PC, although you should be aware that these generally do not default to being 'COM1' which is the default most RS232 applications will use.

The default baud rate is 57600 with 8 data bits, 1 stop bit and no parity. This baud rate can be changed in the System menu to suit other programs if need be.

### 14.2 Communications protocol

The standard communications protocol for your unit is text-based and is a subset of that detailed on our support website for the CORIO<sup>®</sup>2 universal scaler. Also on our website, you can find the Windows<sup>®</sup> Control Panel for your unit. See <http://www.tvone.com/support> for more details, and search for the term 'RS232'.

The protocol is also bi-directional (unit and computer both send messages to each other), so that you can send changes to the unit, and it will also respond with any changes made via alternate methods (front panel buttons, menu changes and infra-red control). This enables any attached computer to be aware of any changes made to the unit from an alternative source rather than itself.

What this means is that you can easily find out the exact command to send to the unit to tell it to perform a certain function. This can be seen by the data that is sent back to the computer when changing values on the unit. For instance, just by selecting an input by pressing a front panel button will cause RS232 data to be sent to the computer that represents the command required to change source.

**Note:** Any command you send to the unit will be replied to, either with an error code or with the actual changed value. This may be different to the one you sent; for example, if trying to set a value too high or too low, or the function is not supported. The detailed description of the protocol on our website explains this further.

## **15 TROUBLESHOOTING AND TECHNICAL SUPPORT**

If problems are experienced, please read through the symptom topics below in order to resolve the problem. After doing so, if you still need to, contact Technical Support at <http://www.tvone.com/support>. Please have the following details of the problem handy:

Whether the problem happens only at specific times or has only just started occurring (and what other things have changed at the same time).

Firmware revision numbers - found in the first item of the System menu (S2-106AD only)

If the problem relates to a specific source.

### **15.1 Your unit does not power up**

When powered, you should see one or more LED's illuminated on the front panel. If this is not the case, and your unit is not connected to a C2 unit, check that the power supply is plugged in and is the correct voltage and polarity.

If your unit is connected to a C2 unit via an OPTION cable and your unit is not powered, your switcher will only be powered via the OPTION cable if there is only a single OPTION cable between your unit and the C2 unit, and the C2 unit must be plugged into a live mains outlet. If this is the case then check the OPTION cable connection itself, otherwise your unit can be powered by an external 12v adapter.

### **15.2 There is no picture on the Output of your video switcher.**

If no LEDs are on, then ensure that the AC power adaptor is connected properly and the power switch is on at the AC outlet.

Check that video is being input to the unit by connecting your video source directly to the receiving equipment.

Check that the display video equipment is set to the correct line input and format/standard as appropriate.

Check that the device connected to the output is on and can support the resolution of the input device.

### **15.3 There is no audio on the output of your S2-106AD audio switcher.**

If no LEDs are on, then ensure that the AC power adaptor is connected properly and the power switch is on at the AC outlet.

Check that the input selected is correct.



Check that audio is being input to the unit by connecting your audio source directly to the receiving equipment. If this is ok, reconnect your S2-106AD and check the volume and balance levels are not set to minimum.

#### **15.4 There is no audio on the output of your S2-101AA Audio Amplifier.**

Ensure that the AC power adaptor is connected properly and the power switch is on at the AC outlet. Note that the S2-101AA cannot be powered from a C2 unit. The volume control buttons should illuminate when the unit is powered.

Ensure that the inputs and speakers are connected and that the volume control is not set to minimum.

#### **15.5 The controls are not responding.**

Check that the unit is powered and that the LEDs are illuminated.

If your remote control is not responding, and your unit is not connected to a C2 unit, remember that you can unlock your remote control by pressing button 1 and standby at the same time. On an S2-101AA press Volume+ and standby.

If you have an S2-106AD audio switcher and you find that you are unable to change parameters via the menu, this should be because you are connected to a C2 unit via an OPTION cable. Parameter adjustment can be done via the C2 unit's front panel, or you can enable adjustment at the switcher by navigating to the 'Scaler control' screen and selecting 'NO'.

If the audio delay is not modifiable, this may be because the sampling frequency is set to 'bypass'.

#### **15.6 The C2 unit menu does not expand.**

If you are connected to a C2 unit via an OPTION cable and the C2 unit menu doesn't expand to show the extra controls or inputs, first check the OPTION cable connection, if this is ok check that each S2 unit is powered. It is possible that a firmware upgrade may be required in your C2 unit, as it may have a version of firmware that is not compatible with the S2 range. See <http://www.tvone.com/support> for more detail.

If you are connecting multiple units to a C2 unit, we recommend a maximum of five units on the OPTION cables. Connecting more than five units may work but TV One cannot guarantee proper operation. For multiple units to operate, all units must be powered.

#### **15.7 The wrong video is routed.**

If your unit is connected to a C2 unit via an OPTION cable and a video lead but the wrong video input gets routed, ensure that the video output from your switcher is connected to the input on the C2 unit with the highest designation. Please refer to the 'OPTION cable control' section for your particular unit for more information.

## 16 RETURN PROCEDURE

*Before returning your unit for repair, there are several checks you can make yourself to make sure the problem is actually caused by a failure.*

### 16.1 Are you sure there's a fault?

Many 'faults' are due to incorrect set-up or use so a simple checklist is provided below to help you identify potential problems.

Set the unit up with your equipment as described in this manual and run through the checklist. This will hopefully determine whether or not the unit is actually faulty and prevent units from being returned unnecessarily.

Check the Troubleshooting tips of this manual and check out the various FAQ (Frequently Asked Questions) listings on the support website, <http://www.tvone.com/support>, which shows the latest Hints, Tips and Solutions.

Don't presume it is the unit that is causing the problem. Check that the equipment being used with it is fully working and setup correctly – bypass the unit if possible by connecting the video source directly to the video display.

Check the AC power. Is it present and is the unit turned on? Check that all cables are properly plugged in and are not damaged and then make certain that all equipment connected to the unit is working properly.

Perhaps you have a "frozen" unit and you cannot change an input nor exit from the current task. In that case, a simple 'Factory Reset' of the product may sort the problem out. See earlier section on Front panel buttons to do this. Note that all user-settings will be lost following an engineering reset.

It is also worth ensuring that the latest firmware is installed in the unit – although, again, user settings are lost during a firmware update.

### 16.2 To return a unit for repair

First contact TV One using the <http://www.tvone.com/support> website. Support personnel will determine whether a return to the factory is the appropriate solution. If that's the case, a Return Authorization Number will be issued. You should provide the following information for each unit:

Product type

Serial number of the faulty unit (this is on the underside of the unit)

Full details of fault

Invoice number (if available)

Units should be returned via insured carrier or registered mail (thus allowing a trace to be made if the Processor is lost in transit), with shipping costs and insurance arranged at your own risk and expense. Goods in transit are the responsibility of the sender and the supplier will not be responsible for transit losses.

Please clearly state the return number on the outside packaging and on any accompanying documentation. This will greatly speed up processing.

***IMPORTANT: DO NOT return a unit for warranty repair without first obtaining a Return Authorization Number. No action will be taken on a unit returned in warranty for repair without a Return Authorization Number.***

## 17 WARRANTY POLICY

LIMITED WARRANTY – With the exceptions noted in the next paragraph, TV One warrants the original purchaser that the equipment it manufactures or sells will be free from defects in materials and workmanship for a period of two years from the date of purchase. Should this product, in TV One's opinion, prove defective within this warranty period, TV One, at its option, will repair or replace this product without charge. Any defective parts replaced become the property of TV One. This warranty does not apply to those products which have been damaged due to accident, unauthorized alterations, improper repair, modifications, inadequate maintenance and care, or use in any manner for which the product was not originally intended.

Items integrated into TV One products that are made by other manufacturers, notably computer hard drives and liquid crystal display panels, are limited to the term of the warranty offered by the respective manufacturers. Such specific warranties are available upon request to TV One.

If repairs are necessary under this warranty policy, the original purchaser must obtain a Return Authorization Number from TV One and return the product to a location designated by TV One, freight prepaid. After repairs are complete, the product will be returned, freight prepaid.

**LIMITATIONS** - All products sold are "as is" and the above Limited Warranty is in lieu of all other warranties for this product, expressed or implied, and is strictly limited to two years from the date of purchase. TV One assumes no liability to distributors, resellers or end-users or any third parties for any loss of use, revenue or profit.

TV One makes no other representation of warranty as to fitness for the purpose or merchantability or otherwise in respect of any of the products sold. The liability of TV One with respect to any defective products will be limited to the repair or replacement of such products. In no event shall TV One be responsible or liable for any damage arising from the use of such defective products whether such damages be direct, indirect, consequential or otherwise, and whether such damages are incurred by the reseller, end-user or any third party.

## 18 CONNECTOR PINOUTS

### 18.1 HD15 connector

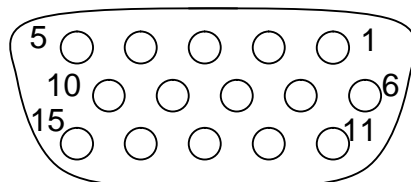

1. Red / Pr / R-Y
2. Green / Y
3. Blue / Pb / B-Y
4. ID2 (input & output linked when source routed)
5. GND
6. GND
7. GND
8. GND
9. No connection
10. GND
11. GND on input.
12. SDA (input & output linked when source routed)
13. H sync (or composite sync for RGBS)
14. V sync
15. SCL (input & output linked when source routed)

### 18.2 DVI-D connector

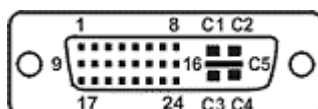

PIN#	SIGNAL	PIN#	SIGNAL
1	T.M.D.S DATA 2-	16	HOT PLUG DETECT
2	T.M.D.S DATA 2+	17	T.M.D.S DATA 0-
3	T.M.D.S DATA 2/4 SHIELD	18	T.M.D.S DATA 0+
4	T.M.D.S DATA 4-	19	T.M.D.S DATA 0/5 SHIELD
5	T.M.D.S DATA 4+	20	T.M.D.S DATA 5-
6	DDC CLOCK [SCL]	21	T.M.D.S DATA 5+
7	DDC DATA [SDA]	22	T.M.D.S CLOCK SHIELD
8	Not used	23	T.M.D.S CLOCK+
9	T.M.D.S DATA 1-	24	T.M.D.S CLOCK-
10	T.M.D.S DATA 1+		
11	T.M.D.S DATA 1/3 SHIELD	C1	Not used
12	T.M.D.S DATA 3-	C2	Not used
13	T.M.D.S DATA 3+	C3	Not used
14	+5V POWER	C4	Not used
15	GND (for +5V)	C5	Not used

### 18.3 4 Pin mini-DIN S-video connector (YC) input



1. Y (Luminance)
2. GND
3. GND
4. C (Chrominance)

### 18.4 RS232 / D9 socket

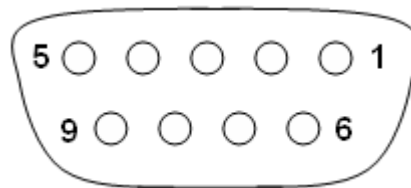

1. N/C
2. TX (Transmit data)
3. RX (Receive data)
4. N/C
5. GND (Signal return)
6. N/C
7. CTS (Clear to send)
8. RTS (Request to send)
9. N/C

### 18.5 Multi-way audio connector on C2 unit (unbalanced)

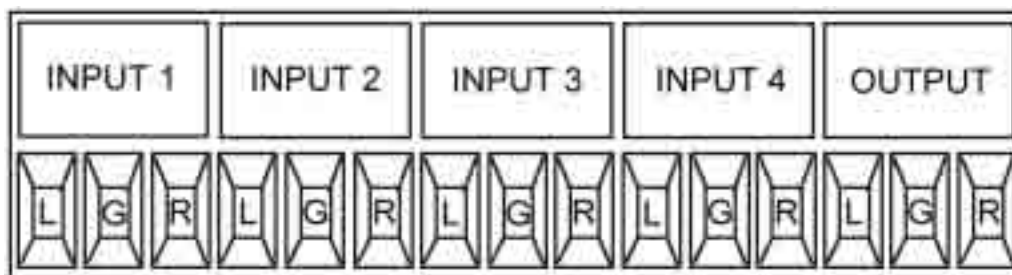

- L = Left signal  
G = Signal ground (shared with left and right)  
R = Right signal

### 18.6 Multi-way audio connector on S2 unit (balanced)

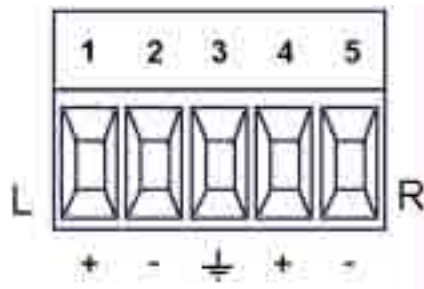

1. Left positive signal (hot)
2. Left negative signal (cold)
3. Signal ground (shared with left and right)
4. Right positive signal (hot)
5. Right negative signal (cold)

## 19 SPECIFICATIONS

See product front and rear diagrams for details of product I/O. Not all units in the S2 series have all the inputs and outputs listed here.

### 19.1 S2-105PC(A), S2-109PC Computer Input / Output

Connectors:	HD-15
Analog input/output impedance:	75 Ohm
HV sync:	TTL Level, 10K input termination, 56ohm output termination (TTL)
RGB Level Range:	0.5-2.0 V p-p approx.
Formats:	Analog RGB/YPbPr supporting RGBHV, RGBS, RGsB & YPbPr EDID pass through for active source
Resolutions:	up to UXGA
Bandwidth:	450MHz

### 19.2 S2-105CV(A) Composite Input / Output

Connectors:	BNC
Analog input/output impedance:	75 Ohm
Signal Level:	1 V p-p approx.
Supported standards:	NTSC, PAL
Bandwidth:	>80MHz

### 19.3 S2-105YC(A) YC Input / Output

Connectors:	S-Video 4-pin mini-DIN
Analog input/output impedance:	75 Ohm
Signal Level:	1 V p-p approx.
Supported standards:	NTSC (YC), PAL (YC)
Bandwidth:	>80MHz

### 19.4 S2-105DVIA Input / Output

Connectors:	DVI-I (handling DVI-D only)
DVI Resolutions:	upto 1600x1200@60Hz & 1920x1080p@60Hz
Formats:	DVI-D with EDID & HDCP DVI HDMI compatible (with DVI to HDMI adapters)
Bandwidth:	1.65GHz

### 19.5 S2-101AA Input / Output

Inputs:	Stereo RCA (phono) differential inputs Stereo differential Mini-Combicon terminal inputs Stereo single ended PC input with 3.5mm jack socket
Outputs:	Spring lock wire speaker terminals
Minimum load impedance	4 ohms



Output power	10W rms into 4 ohms with 12.0V supply
Amplifier type	Optimized Class D with on-off-mute pop noise suppression, short circuit and over temperature protection
Frequency response	20Hz to 24kHz (-3dB)
THD+N	0.07% @ 1kHz 1W into 4 ohms 0.23% (output at maximum before clipping)
Signal/Noise	better than 71dB @ 1kHz unweighted
Crosstalk:	better than -63dB @ 1kHz to 20kHz (output at maximum before clipping)
Nominal input level:	353mVrms unbalanced, 1.77Vrms balanced
Input sensitivity:	848mVrms (-1.43dBV) balanced 84mVrms (-19.4dBu) unbalanced for maximum output (>10Watts into 4 Ohm load) before clipping.
Input impedance:	27k ohms unbalanced, 24k ohms balanced

NOTE: 0dBu=0.775Vrms & 0dBV=1Vrms

### 19.6 S2-106AD Audio Input / Output

Inputs:	5 un-balanced RCA, 5 balanced mini-combicon, 1 un-balanced 3.5mm PC input
Outputs:	1 un-balanced RCA, 1 balanced mini-combicon, 1 headphone 3.5mm jack
Maximum input:	+14dBu (Bypass) / +10dBu (delay)
Maximum output:	+13dBu
Gain adjustment:	+13dBu to -14dBu
Nominal level:	0dBu
Bandwidth:	50Hz – 20kHz > - 0.5dB At 20 Hz > - 1.5 dBu balanced > - 3.0 dBu unbalanced
Cutoff frequency:	-3dB @ 180kHz (in bypass mode)
THD + noise:	<0.015% (+4dBu 1kHz) 0.013% (nominal level 1kHz)
S/N ratio:	75dB (unweighted +10dBu) 70dB (at maximum output)
Crosstalk:	<-75dB @ 1kHz (0dBu input)
Sampling frequencies:	32kHz, 44.1kHz, 48kHz, 96kHz
Sampling resolution:	24 bit
Digital delays:	0-999ms (@ fs=32kHz) 0-740ms (@ fs=44.1kHz) 0-680ms (@ fs=48kHz) 0-340ms (@ fs=96kHz)
Delay adjustment resolution:	1.0ms
Minimum delay:	0s (in bypass mode)

### 19.7 S2-108HD Video Input / Output

Connectors:	BNC (eight inputs, two outputs [identical])
-------------	---

Analog input/output impedance: 75 Ohm  
Signal Level: 800 mV p-p approx.  
Supported standards: SMPTE 292M and 259M  
Reclocking and Equalization: Automatic  
Maximum Data Rate: 1.485 Gbps  
Maximum Jitter 0.2UI

### **19.8 Warranty**

Limited warranty: 2 years parts and labor

### **19.9 Regulatory Compliance**

Main unit conforms to FCC, CE, RoHS

### **19.10 Environmental**

Operating Temperature 0° to +45° C (+32° to +113° F)  
Operating Humidity 10% to 85%, Non-condensing  
Storage Temperature -10° to +70° C (+14° to +158° F)  
Storage Humidity 10% to 85%, Non-condensing

### **19.11 Power Requirement**

Actual current consumption varies between units.

Internal over-voltage & over-current protection.

External power supply specification: 12v DC regulated 1Amp PSU (12V DC @ .4A STD-104 for S2-101AA), with a 2.5mm locking center-pin positive DC power connector. A non-locking 2.5mm DC power connector will also fit.

### **19.12 Control Methods**

The unit can be controlled locally via the front panel buttons, or in the case of an S2-106AD, a multi-directional switch and Liquid Crystal Display. It can also be controlled remotely via the RS-232 interface using a D9 female connector, or using an Infra-red remote using the IRC-4 or IRC-5 remote unit.

### **19.13 Accessories Included**

A breakout OPTION cable is shipped with each S2 switcher.

### **19.14 Mechanical**

Size (H x W x D): 1.6" x 8.6" x 5.9" (41.5 x 218 x 150mm)  
Weight (Net): 2.6 lbs (1.2 kg) (different unit types may vary)

### **19.15 Optional Accessories**

RM-220: single/dual rack-mount Kit

## 20 CONTACT INFORMATION

Should you have any questions or require assistance with this product in areas not covered by this manual, please contact TV One at the appropriate location shown below:

### **TV One USA**

1350 Jamike Drive  
Erlanger, KY 41018  
USA  
Tel 859-282-7303  
Fax 859-282-8225  
sales@tvone.com  
www.tvone.com

### **TV One Asia**

11F, No. 28, Sec. 2  
San-Min Road, Panchiao City  
Taipei Hsien 220  
Taiwan ROC  
Tel +886 2 8951-0674  
Fax +886 2 8951-0675  
sales.asia@tvone.com  
www.tvoneasia.com

### **TV One Latin America**

2790 NW 79 Avenue  
Miami, FL 33122  
USA  
Tel 305-418-9305  
Fax 305-418-9306  
sales.latinoamerica@tvone.com  
www.tvonela.com

### **TV One Europe**

Continental Approach  
Westwood Industrial Estate  
Margate, Kent CT9 4JG, UK  
Tel +44 (0)1843 873311  
Fax +44 (0)1843 873312  
sales.europe@tvone.com  
www.tvone.co.uk

### **TV One China**

Room 1007, Golden Peach Building  
No.1900 Shangcheng Road  
Pudong, Shanghai,  
China 200120  
Tel +86 21 5830-2960  
Fax +86 21 5851-7949  
sales.china@tvone.com  
www.tvonechina.com

### **TV One Mercosur**

Honduras 5849 2<sup>nd</sup> Floor Office C  
(C1414BNI) Capital Federal  
Buenos Aires, Argentina  
Tel +54 11 4771-5570  
Fax +54 11 4771-5570  
sales.mercosur@tvone.com  
www.tvonela.com

