



## CPLUS-44PLV

4x4 4K UHD+ HDMI over HDBaseT Matrix with AVLC



Operation Manual



## DISCLAIMERS

The information in this manual has been carefully checked and is believed to be accurate. Cypress Technology assumes no responsibility for any infringements of patents or other rights of third parties which may result from its use.

Cypress Technology assumes no responsibility for any inaccuracies that may be contained in this document. Cypress also makes no commitment to update or to keep current the information contained in this document.

Cypress Technology reserves the right to make improvements to this document and/or product at any time and without notice.

## COPYRIGHT NOTICE

No part of this document may be reproduced, transmitted, transcribed, stored in a retrieval system, or any of its part translated into any language or computer file, in any form or by any means—electronic, mechanical, magnetic, optical, chemical, manual, or otherwise—without express written permission and consent from Cypress Technology.

© Copyright 2018 by Cypress Technology.

All Rights Reserved.

## TRADEMARK ACKNOWLEDGMENTS

All products or service names mentioned in this document are trademarks of the companies with which they are associated.





## SAFETY PRECAUTIONS

Please read all instructions before attempting to unpack, install or operate this equipment and before connecting the power supply. Please keep the following in mind as you unpack and install this equipment:

- Always follow basic safety precautions to reduce the risk of fire, electrical shock and injury to persons.
- To prevent fire or shock hazard, do not expose the unit to rain, moisture or install this product near water.
- Never spill liquid of any kind on or into this product.
- Never push an object of any kind into this product through any openings or empty slots in the unit, as you may damage parts inside the unit.
- Do not attach the power supply cabling to building surfaces.
- Use only the supplied power supply unit (PSU). Do not use the PSU if it is damaged.
- Do not allow anything to rest on the power cabling or allow any weight to be placed upon it or any person walk on it.
- To protect the unit from overheating, do not block any vents or openings in the unit housing that provide ventilation and allow for sufficient space for air to circulate around the unit.
- Please completely disconnect the power when the unit is not in use to avoid wasting electricity.

## VERSION HISTORY

REV.	DATE	SUMMARY OF CHANGE
RDV1	2019/05/03	Preliminary release



# CONTENTS

<b>1. Introduction</b> .....	<b>1</b>
<b>2. Applications</b> .....	<b>1</b>
<b>3. Package Contents</b> .....	<b>2</b>
<b>4. System Requirements</b> .....	<b>2</b>
<b>5. Features</b> .....	<b>3</b>
<b>6. Operation Controls and Functions</b> .....	<b>4</b>
6.1 Front Panel.....	4
6.2 Rear Panel.....	6
6.3 Remote Control.....	8
6.4 IR Cable Pinouts .....	9
6.5 RS-232 Pinout and Defaults .....	9
6.6 OLED Menu .....	10
6.7 WebGUI Control.....	14
6.7.1 Video Switch Tab .....	16
6.7.2 Zone A/V Pairing Tab.....	18
6.7.3 EDID Settings Tab .....	20
6.7.4 HDBaseT & H/W Tab.....	22
6.7.5 User Config Tab .....	23
6.7.6 System Settings Tab .....	23
6.8 Telnet Control .....	25
6.9 RS-232 and Telnet Commands .....	26
<b>7. Connection Diagram</b> .....	<b>40</b>
<b>8. Specifications</b> .....	<b>41</b>
8.1 Technical Specifications .....	41
8.2 Video Specifications .....	42
8.3 Audio Specifications .....	44
8.3.1 Digital Audio .....	44
8.3.2 Analog Audio .....	44
8.4 Cable Specifications .....	44
8.5 HDBaseT Features.....	45
<b>9. Acronyms</b> .....	<b>46</b>

---



## 1. INTRODUCTION

This 4×4 HDMI over HDBaseT Matrix with AVLC supports routing and transmission of video (resolutions up to 4K@60Hz w/ HDMI 2.0 & HDCP 2.2) and audio while providing flexible control via IR, RS-232, Telnet or WebGUI. As many as four HD sources may be routed to any of four destinations via single runs of cable up to a distance of 70m.

Despite HDBaseT's 10.2Gbps bandwidth limitation, 4K UHD HDMI video sources, up to and including 4K@60Hz (4:4:4, 8-bit) as well as 10/12 bit sources with HDR, are able to be processed and extended by the use of AVLC (Adaptive Visually Lossless Compression) when needed. 3D video is also supported when compatible sources and displays are connected.

This unit supports passing up to 8 channel LPCM digital audio as well as Bitstream and HD Bitstream audio formats. Additionally, four analog stereo audio outputs are available to provide breakout audio from the associated HDBaseT output (LPCM 2.0 sources only).

The included PoH (Power over HDBaseT) functionality can supply remote power to compatible HDBaseT Receivers, providing greater flexibility in your installations. Control is via front panel buttons with an OLED menu, WebGUI, Telnet, RS-232 or IR remote.

## 2. APPLICATIONS

- Full audio/video matrix systems
- Residential AV matrix installations
- Commercial AV matrix installations
- Security systems
- University lecture hall systems
- Retail installation system

### 3. PACKAGE CONTENTS

- 1× 4×4 4K UHD+ HDMI over HDBaseT Matrix with AVLC
- 1× 24V/6.25A DC Power Adapter
- 1× Power Cord
- 2× IR Extender Cable
- 2× IR Blaster Cable
- 1× Remote Control (CR-163)
- 1× Shockproof Feet (Set of 4)
- 1× Operation Manual

### 4. SYSTEM REQUIREMENTS

- HDMI source equipment such as media players, video game consoles or set-top boxes.
- HDMI receiving equipment such as HDTVs, monitors or audio amplifiers.
- HDBaseT Receivers equipped with AVLC (Adaptive Visually Lossless Compression) and PoH (PD) support is strongly recommended.
- The use of Premium High Speed HDMI cables, and industry standard Cat.6, Cat.6a or Cat.7, is highly recommended.



## 5. FEATURES

- HDMI with HDR & 4K@60Hz support, DVI 1.0 compatible
- HDCP 1.x and HDCP 2.2 compliant
- Routes four HDMI sources to four displays using four HDBaseT outputs
- Supports up to 4K UHD (18Gbps, 4K@60Hz 4:4:4, 8-bit) video input and output
- Supports deep color input and output up to 12-bit
- Supports 10-bit and 12-bit HDR (High Dynamic Range) bypass (Output requires AVLC receiver)
- Integrated AVLC (Adaptive Visually Lossless Compression) activates when the bandwidth requirements of the source are beyond 10.2Gbps allowing for support of sources up to 18Gbps with no loss of visual quality via compatible HDBaseT Receivers
- Supports automatic conversion of 4K@50/60Hz (4:4:4) sources to 4K@50/60Hz (4:2:0) or 1080p50/60 for non-AVLC HDBaseT receivers or if a connected display can't support the original resolution.  
*Note: 1080p conversion is only available on outputs A & C.*
- Supported HDBaseT feature set: HD Video & Audio, PoH (PSE), and Control (Bidirectional IR pass through)
- 4K signals can be transmitted up to 35m via Cat.5e/6 and up to 40m via Cat.6a/7
- Supports pass-through of these standard digital audio formats via HDBaseT: LPCM (up to 8 channels), Bitstream, and HD Bitstream
- High quality Digital to Analog Conversion (DAC) of LPCM 2.0 audio sources for local audio breakout.
- Supports generation of OSD banner information
- Advanced internal and external EDID management with 4 sets of configurable EDID settings
- 1U rack mounted design
- Control via front panel controls, Ethernet (Telnet & WebGUI), RS-232, & IR remote







**7 +/-IN Button:** Inside the OLED menu, this button moves you up within the menu tree. Otherwise, in routing mode, this button allows you to make your input source selection.

**-/OUT Button:** Inside the OLED menu, this button moves you down within the menu tree. Otherwise, this button activates routing mode and allows you to begin your output destination selections

**8 PRESET Button:** Press this button to recall saved presets. Press the "Preset" button followed by a number button and the "Enter" button to recall the stored preset assigned to that number. A maximum of 8 presets can be stored in the unit. Presets are created and stored via the WebGUI.

*Note: Please refer to section 6.7.1 for advanced preset settings.*

**9 LOCK Button:** Press this button to lock all buttons on the front panel, or press and hold it for 3 seconds to unlock a locked front panel.

*Note: The OLED will display an "L" in the upper right corner to indicate the front panel is locked.*

**10 OLED Window:** Displays the unit's menu, settings and information.

## 6.2 Rear Panel

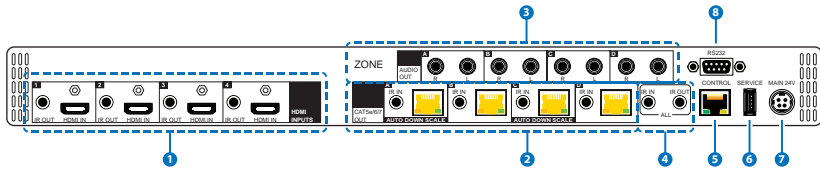

- 1 HDMI IN 1~4 Ports:** Connect to HDMI source equipment such as media players, game consoles, or set-top boxes. DVI sources are supported with the use of an HDMI to DVI adapter.

**IR OUT 1~4 Ports:** Connect to IR Blasters to transmit IR signals from the other end of the HDBaseT connections to devices within direct line-of-sight of the IR Blaster.

*Note: Returning IR signals follow the HDMI signal routing and will also be output via the ALL IR OUT port. IR signals from the connected HDBaseT receivers can also be used to control this matrix remotely.*
- 2 CAT5e/6/7 OUT Ports:** Connect to compatible HDBaseT Receivers with Cat.5e/6/7 cables for transmission of all data signals. PoH will also be supplied to a connected compatible PD Receiver.

*Note: Output of 4K signals with 10/12-bit HDR (High Dynamic Range) color requires compatible AVLC receivers. If standard HDBaseT receivers are detected the signal will be automatically converted to 8-bit color. 4K sources routed to outputs A & C will be automatically scaled to 1080p if the connected display can't support 4K.*

**IR IN A~D Ports:** Connect to IR Extenders to receive IR control signals and extend them to devices connected to the other end of the associated HDBaseT connection. Ensure that the remote being used is within direct line-of-sight of the IR Extender.
- 3 ZONE AUDIO OUT A~D Ports:** Four sets of analog stereo audio outputs. Connect to powered speakers or an amplifier for analog stereo audio output from each associated HDBaseT output. (LPCM 2.0 sources only).
- 4 IR IN (ALL) Port:** Connect an IR Extender to this port for IR signal reception. All IR signals received will be broadcast by all IR blasters connected to the matrix and to all connected HDBaseT receivers.



Please ensure that the remote being used is within direct line-of-sight of the IR Extender.

**IR OUT (ALL) Port:** Connect an IR Blaster to this port to broadcast IR signals. All IR signals received by any IR Extenders connected to the matrix or HDBaseT receivers will be broadcast. Please place the IR Blaster in direct line-of-sight of the equipment to be controlled.

- 5 CONTROL Port:** Connect directly, or through a network switch, to your PC/laptop to control the unit via Telnet/WebGUI.
- 6 SERVICE Port:** This port is reserved for firmware update use only.
- 7 MAIN 24V Port:** Plug the 24V DC power adapter into this port and connect it to an AC wall outlet for power.
- 8 RS232 Port:** Connect directly to a PC, laptop, or other serial control device to send RS-232 commands to control the unit.

## 6.3 Remote Control

- 1 **POWER Button:** Press to power the unit on or place it into stand-by mode.
- 2 **LOCK Button:** Press to lock/unlock the front panel of the matrix unit.
- 3 **MUTE Button:** No function.
- 4 **IN 1~4, OUT A~D & PATTERN Buttons:**

**[Local matrix control]:** When controlling the unit directly, input and output selection behaves the same as the front panel buttons with the “Pattern” button acting as an additional test pattern source.

*Note: Refer to section 6.1 for more details.*

**[Zone A/V Pairing]:** When controlling the unit via an HDBaseT receiver in a remote location, pressing buttons 1~10 will switch to the A/V source assigned to the number depending on your current zone. These assignments are configured via the WebGUI.

*Note: Refer to section 6.7.2 for more details.*

- 5 **MENU/CANCEL Button:** Press the “MENU/CANCEL” button to enter the OLED menu, or to back out from menu items.
- 6 **PRESET Button:** Recall matrix presets. Press the “Preset” button followed by a number button to recall the stored preset assigned to that number. The presets are configured within the WebGUI.
- 7 **+ / IN Button:** Within the menu, this button moves you up within the menu tree. Otherwise, in routing mode, this button allows you to make your input source selection.  
**- / OUT:** Within the menu, this button moves you down within the menu tree. Otherwise, this button starts routing mode and allows you to begin your output destination selections.  
**◀ / VOL- & ▶ / VOL+ Button:** No function.
- 8 **ENTER:** Press this button to confirm selections.

*Note: This remote control is designed for the full family of matrix products. Some functions are not available on all units.*

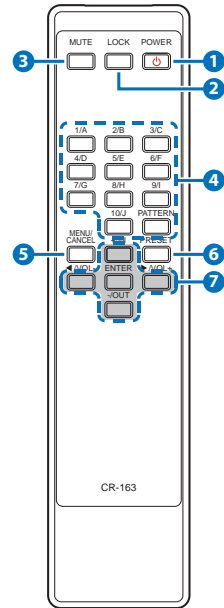

## 6.4 IR Cable Pinouts

IR Blaster Cable

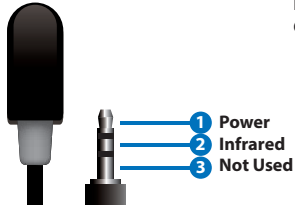

IR Extender Cable

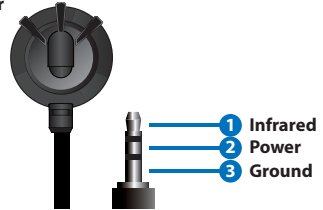

## 6.5 RS-232 Pinout and Defaults

Serial Port Default Settings	
Baud Rate	19200
Data Bits	8
Parity Bits	None
Stop Bits	1
Flow Control	None

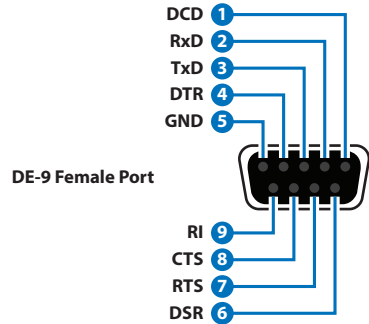

## 6.6 OLED Menu

All basic functions of this unit can be controlled by using the front panel's OLED menu which is activated by pressing the MENU/CANCEL button on the front of the unit. Use the + (PLUS), - (MINUS), and ENTER buttons to navigate the menu. Press the MENU/CANCEL button to back out from any menu item and then press it again to close the menu. The number buttons may also be used to quickly navigate the numbered menu items.

When not in the menu, the model name and IP address of the unit will be displayed. Additional networking information (netmask and gateway) can be displayed by repeatedly pressing the "+" or "-" buttons on the front panel or remote control.

MAIN MENU
1-EDID
2-Network
3-Factory Default
4-Firmware
5-Miscellaneous

The individual functions of the OLED menu will be introduced in the following section. Items marked in **BOLD** are the factory default settings.

1-EDID	
2ND LEVEL	3RD LEVEL
1-EDID Mode	<b>ALL</b>
	Independent

1-EDID	
2ND LEVEL	3RD LEVEL
2-EDID Select (All or 1-4)	<b>1-FHD/2CH</b>
	2-FHD/Mch
	3-UHD/2ch
	4-UHD/Mch
	5-UHD+/2ch
	6-UHD+/Mch
	7-Sink A
	8-Sink B
	9-Sink C
	10-Sink D
	11-User 1
	12-User 2
	13-User 3
	14-User 4

- 1) **EDID Mode:** Select the EDID mode of the unit between All or Independent. "All" mode assigns the same EDID to all inputs. "Independent" mode allows each input to have a different EDID.
- 2) **EDID Select:** In "All" mode, select the EDID to use with all inputs. In "Independent" mode, press the numbered button of the input to adjust, and then select the EDID to use with that input. After making a selection press the "Enter" button to save the change.

2-NETWORK	
2ND LEVEL	3RD LEVEL
1-Link Status	[Current link status]
2-IP Address	[Unit's current IP address]
3-Subnet Mask	[Unit's current subnet mask]
4-Gateway Address	[Unit's current gateway address]
5-MAC Address	[Unit's MAC address]



2-NETWORK	
2ND LEVEL	3RD LEVEL
6-DHCP Mode	On
	OFF

- 1) **Link Status:** Displays the current Ethernet link status.
- 2) **IP Address:** When DHCP is off, the IP address can be set here. The digit currently being edited will flash. The editable digit can be changed by using the +/- buttons. Press a front panel number button to enter a new number. Press the "Enter" button to store the current number segment and move to the next segment.  
*Note: The unit's default static IP address is 192.168.1.50.*
- 3) **Subnet Mask:** When DHCP is off, the subnet mask can be set here. The digit currently being edited will flash. The editable digit can be changed by using the +/- buttons. Press a front panel number button to enter a new number. Press the "Enter" button to store the current number segment and move to the next segment.
- 4) **Gateway Address:** When DHCP is off, the gateway address can be set here. The digit currently being edited will flash. The editable digit can be changed by using the +/- buttons. Press a front panel number button to enter a new number. Press the "Enter" button to store the current number segment and move to the next segment.
- 5) **MAC Address:** Displays the unit's MAC address.
- 6) **DHCP Mode:** Enable or disable DHCP mode. When enabled, all IP address information will be assigned automatically by the local DHCP server. When disabled, the IP address must be set manually.  
*Note: When DHCP is enabled, the IP address, subnet mask, and gateway address can not be edited.*

3-FACTORY DEFAULT	
2ND LEVEL	3RD LEVEL
Factory Reset?	Yes
	NO

- 1) **Factory Reset:** Selecting "Yes" will perform a factory reset and return the unit to its factory default state. After the reset is complete, the unit will reboot automatically.

4-FIRMWARE	
2ND LEVEL	3RD LEVEL
1-Version	[Unit's current firmware version]
Factory Reset?	Yes
	<b>NO</b>

- 1) **Version:** Displays the unit's current firmware version.
- 2) **Update:** Provides a way to update the unit's firmware. To begin the firmware update process, select "Yes" followed by pressing the "Enter" button. Next, insert a USB thumb drive, with a valid firmware file (\*.bin format) in the root directory, into the unit's USB service port and the update will begin automatically. The unit will automatically reboot to complete the update process.

5-MISCELLANEOUS	
2ND LEVEL	3RD LEVEL
1-IR Remote Channel	0 ~ 15 <b>[0]</b>
2-Discrete IR Address	[Displays current status]
3-System Baud Rate	[Displays current baud rate]

- 1) **IR Remote Channel:** Select the IR remote channel that the unit will accept signals on.
- 2) **Discrete IR Address:** Displays the current discrete IR address state.
- 3) **System Baud Rate:** Displays the unit's current serial control baud rate.

## 6.7 WebGUI Control

- **Device Discovery**

Please obtain the “Device Discovery” software from your authorized dealer and save it in a directory where you can easily find it.

Connect the unit and your PC/Laptop to the same active network and execute the “Device Discovery” software. Click on “Find Devices on Network” and a list of devices connected to the local network will show up indicating their current IP address.

*Note: The unit’s default IP address is 192.168.1.50.*



Product Name	Description	IP Address	MAC Address

By clicking on one of the listed devices you will be presented with the network details of that particular device.

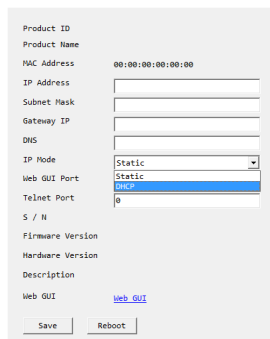

Product ID  
Product Name  
MAC Address 00:00:00:00:00  
IP Address  
Subnet Mask  
Gateway IP  
DNS  
IP Mode Static  
Web GUI Port Static  
Telnet Port 0  
S / N  
Firmware Version  
Hardware Version  
Description  
Web GUI [Web GUI](#)  
Save Reboot

- 1) **IP Mode:** If you choose, you can alter the static IP network settings for the device, or switch the unit into DHCP mode to automatically obtain proper network settings from a local DHCP server. To switch to DHCP mode, please select DHCP from the IP mode drop-down, then click “Save” followed by “Reboot”.
- 2) **WebGUI Hotkey:** Once you are satisfied with the network settings, you may use them to connect via Telnet or WebGUI. The network information window provides a convenient link to launch the WebGUI directly.

- **WebGUI Overview**

After connecting to the WebGUI's address in a web browser, a login prompt will appear. Please enter the appropriate user name and password then click "Sign In" to log in.

*Note: The default user name and password is "admin".*

On the left side of the browser you will see the following menu tabs where all primary functions of the unit are controllable via the built in WebGUI. The individual functions will be introduced in the following sections.

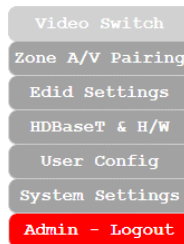

Clicking the red "Logout" tab will automatically log the currently connected user out of the WebGUI and return to login page.

### 6.7.1 Video Switch Tab

This tab provides control over video routing, input and output naming, test pattern configuration, and preset storage/recall.

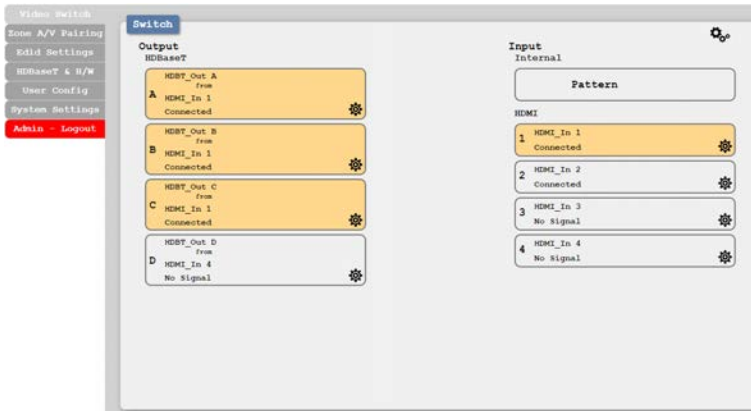

- 1) **Output and Input Routing:** To begin assigning a new video route, please click the button of the HDBaseT output you wish to send video to and then click on the button of the preferred HDMI input port or Pattern. If desired, you may select more than one output prior to selecting the input. As you select each button they will change their color to orange. The new route will become active immediately and the routing information displayed on the buttons will change accordingly.

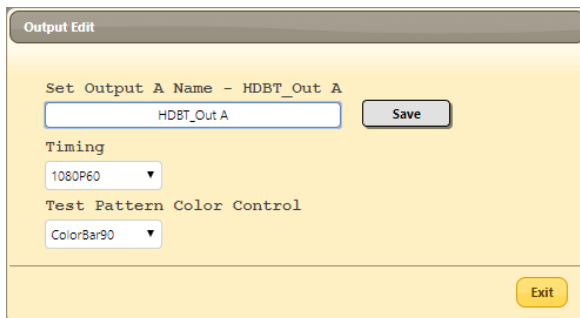

- 2) **Output Edit:** Clicking on the "Edit" icon (⚙️) for an output provides a way to change the name of the output. It also provides control over the test pattern resolution and style used when the "Pattern"

source is routed to the output. Click the “Save” button to confirm a name change.

*Note: Blank spaces are not allowed in names.*

- **Timing:** Test patterns can be generated on any HDBaseT output at the following standard resolutions with a variety of refresh rates: 480i/p, 576i/p, 720p, 1080p, 4K.

*Note: Test pattern output does not enable HDCP.*

- **Test Pattern Color Control:** The test pattern type can be changed to any one of 15 different options. The patterns include full screen colors as well as a selection of other basic patterns.

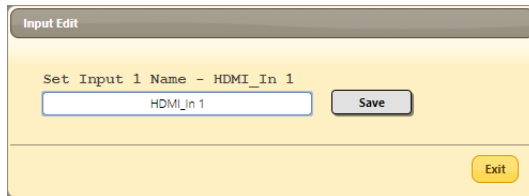





- 3) **Input Edit:** Clicking on the “Edit” icon (⚙️) for an input allows editing of the name for that input. Click the “Save” button to confirm a name change.

*Note: Blank spaces are not allowed in names.*



4) **Preset Settings:** This matrix can store up to eight routing presets. Presets can be utilized to store multiple different routing states in advance for rapid, hassle-free, recall. To store, recall or view a preset, click the "Preset" icon () in the upper right corner of the tab to open the Preset configuration window.

- **Save:** Click the "Save" icon () next to the preferred Preset to store the current matrix configuration into that preset. After updating the preset, the information box to the right will show the new routing details.
- **Load:** When you wish to load a previously stored setting, please click the "Load" icon () associated with the Preset you wish to load. The Preset will load immediately upon clicking the icon.
- **Information:** Click the "Information" icon () next to the preferred Preset to view the current contents of the specified preset in the information box to the right.
- **Rename:** Click the "Edit" icon () to open the rename sub window. After entering a new name, click the "Save" button to confirm the name change.

*Note: Blank spaces are not allowed in names.*

### 6.7.2 Zone A/V Pairing Tab

The Zone A/V Pairing function allows the end user to control the matrix, using the supplied remote control, in a customized manner while in remote rooms (zones) containing an HDBaseT receiver and IR extender.

Each zone can have a different set of sources assigned to the buttons on the remote control for easy switching. The video and audio routing selections for each of the four HDBaseT outputs need to be set up via the WebGUI in advance.



After configuring the button pairing for a zone, the user can change the routing in whichever zone they are currently located simply by pressing a number key on the remote control. The discrete zone pairings can also be activated from within the WebGUI or by using Telnet/RS-232 commands.

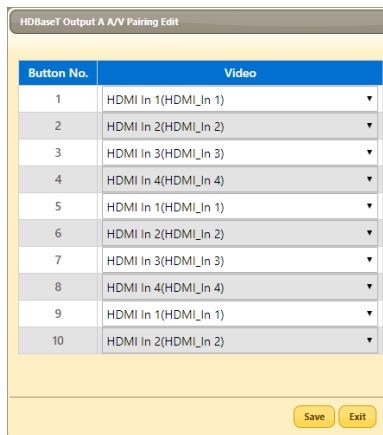

- 1) **Video and Audio Pairing Edit:** Click the “Edit” icon (⚙️) in the output zone you wish to configure and then select the video source to associate with each IR remote button when used within that zone. Once you have completed your selections press “Save”.



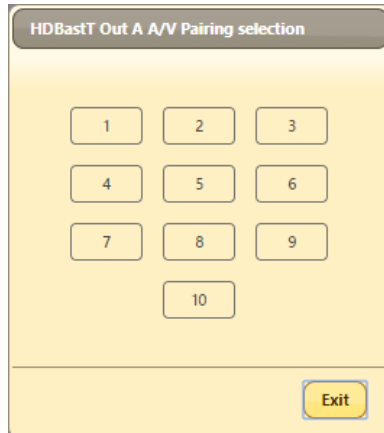

- 2) **Quick Button Selection:** To activate an audio/video pairing from the WebGUI, select the preferred output zone (A~D) to launch its selection window. The numbers 1~10 correspond to the keys on the remote control and hovering the mouse over each button will reveal the routing currently associated with it.

### 6.7.3 EDID Settings Tab

This matrix provides the option of six standard EDIDs, four sink sourced EDIDs and four customer uploaded EDIDs that can be assigned to each input port individually. The names of the four customer uploaded EDIDs can be changed if desired.

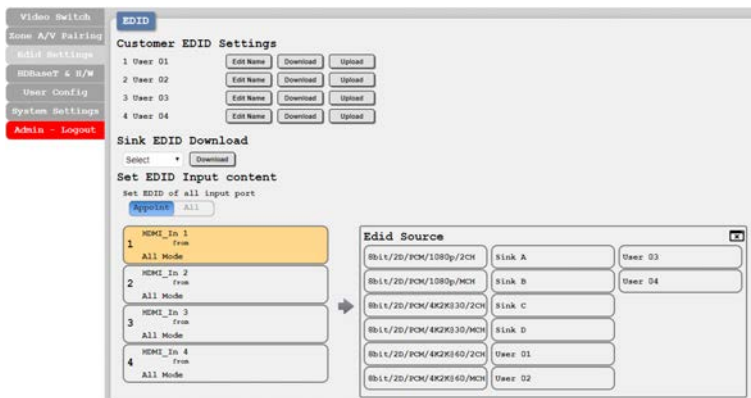



## 1) Customer EDID Settings

- **Edit Name:** Click the “Edit Name” button next to the Customer EDID you wish to rename. Click the “Save” button to confirm the change.
- **Download:** To save an existing Customer EDID to your local PC, press the “Download” button next to the Customer EDID you would like to save. An EDID Download sub-window will appear, allowing you to save the EDID file (\*.bin format) to your local PC. Select a save location and click the “Download” button in the sub window, and the file will be transferred to your PC.
- **Upload:** To upload a Customer EDID into the unit, please click the “Upload” button next to the Customer EDID you would like to replace. An EDID Upload sub-window will appear, allowing you to select and upload the new EDID file (\*.bin format) from your local PC. Once the correct file has been selected, click the “Upload” button in the sub-window, and the file will be transferred to the unit.

2) **Sink EDID Download:** To save the EDID of a connected sink to your local PC, select the sink from the dropdown and then press the “Download” button. An EDID Download sub-window will appear, allowing you to save the EDID file (\*.bin format) to your local PC.

3) **Set EDID Input Content:** The Set EDID Input Content section allows for the assignment of an EDID to each individual input port, or to all inputs at once. Click the selection bar to toggle between “Appoint” (individual assignment), or “All” inputs.

This unit provides the following 6 default EDIDs:

Unit's Default EDIDs		
FHD/2CH	1920×1080p@60Hz (148MHz) & 8 bit color	LPCM 2.0
FHD/MCH	1920×1080p@60Hz (148MHz) & 8 bit color	LPCM 7.1 & Bitstream
UHD/2CH	3840×2160p@30Hz (297MHz) & Deep Color (8/10/12-bit)	LPCM 2.0
UHD/MCH	3840×2160p@30Hz (297MHz) & Deep Color (8/10/12-bit)	LPCM 7.1 & Bitstream

Unit's Default EDIDs		
UHD+/2CH	3840×2160p@60Hz (594MHz) & Deep Color (8/10/12-bit)	LPCM 2.0
UHD+/MCH	3840×2160p@60Hz (594MHz) & Deep Color (8/10/12-bit)	LPCM 7.1 & Bitstream

Note: In some rare cases it is possible for custom or external EDIDs to cause compatibility issues with certain sources. If this happens, it is recommended to switch to one of the 6 default EDIDs for maximum compatibility.

### 6.7.4 HDBaseT & H/W Tab

This tab provides information concerning the temperature inside the unit, the connection status of all outputs, and the HDBaseT firmware versions used by the unit and any connected receivers.

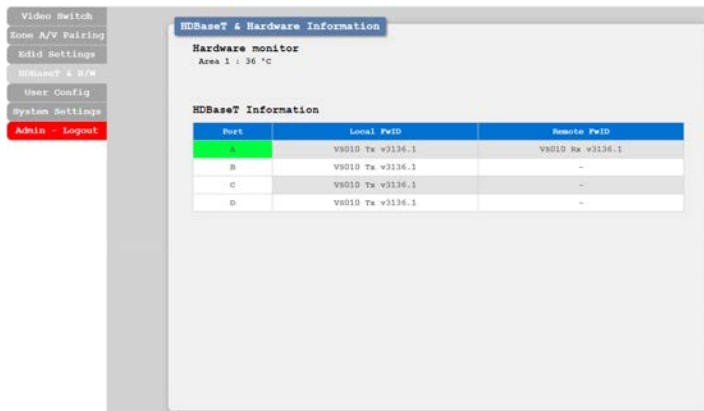

- 1) **Hardware Monitor:** Displays the current temperature inside the unit.
- 2) **HDBaseT Information:** Displays the HDBaseT firmware used by the unit and all connected receivers. The color of the "Port" column indicates the status of the connection between each output and its associated receiver. Green indicates a good and stable connection, white indicates no detected receiver, and red indicates excessive errors or a communication fault.

### 6.7.5 User Config Tab

The WebGUI username and password are set on this page. Two management levels are available: "Administrator" and "General User". The administrator username ("admin") cannot be changed. The "Administrator" user has access to change all settings. The "General User" is not permitted to access or change information on the EDID Settings or System Settings pages.



### 6.7.6 System Settings Tab

This tab provides system configuration options including turning the power on/off, changing the network settings, downloading/restoring saved system configurations, resetting the system to factory defaults and updating the firmware.

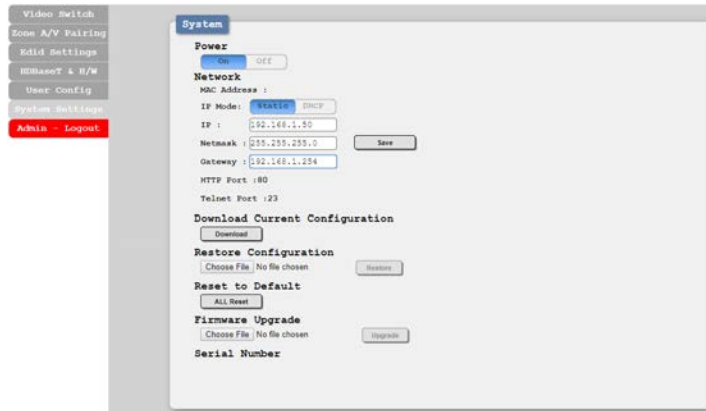

- 1) **Power:** Press this switch to toggle the unit's power between ON and OFF (standby mode).  
*Note: While in standby mode the unit's WebGUI, Telnet and RS-232 controls are still active.*
- 2) **Network:** The unit's IP mode may be switched between Static IP or DHCP. In Static IP mode the IP, netmask and gateway addresses may be manually set. When in DHCP mode, the unit will attempt to connect to a local DHCP server and obtain IP, netmask and gateway addresses automatically. Please press "Save" after making any changes to the IP configuration or mode.  
*Note: The unit's default IP address is 192.168.1.50. If the IP address is changed then the IP address required for WebGUI and Telnet access will also change accordingly.*
- 3) **Download Current Configuration:** Click the "Download" button to save the current system configuration to your local PC. The current system configuration will be saved as an XML file.
- 4) **Restore Configuration:** To restore a previously saved system configuration, click the "Choose File" button to locate the saved XML file, then click the "Restore" button.
- 5) **Reset to Default:** Press the "ALL Reset" button to reset the unit to its factory default state. After the reset is complete, the unit will reboot automatically.
- 6) **Firmware Upgrade:** To update the unit's firmware, click the "Choose File" button to open the file selection window and then select the firmware update file (\*.bin format) located on your local PC. After selecting the file, click the "Upgrade" button to begin the firmware update process. The unit will automatically reboot to complete the update process.
- 7) **Serial Number:** Displays the unit's serial number.

## 6.8 Telnet Control

Before attempting to use Telnet control, please ensure that both the unit and the PC are connected to the same active networks.

Unit's Default EDIDs	
Windows 7	Click <b>Start</b> , type "cmd" in the search field, and press <b>Enter</b> .
Windows XP	Click <b>Start &gt; Run</b> , type "cmd", and press <b>Enter</b> .
Mac OS X	Click <b>Go &gt; Applications &gt; Utilities &gt; Terminal</b> .

Once in the Command Line Interface (CLI) type "**telnet**" followed by the IP address of the unit (and the port number if it is non-standard) and then hit "**Enter**". This will connect us to the unit we wish to control.

```
Microsoft Windows [Version 6.1.7601]
Copyright (c) 2009 Microsoft Corporation. All rights reserved.

C:\Users\Administrator>telnet 192.168.1.50 23
```

*Note 1: If the IP address is changed then the IP address required for Telnet access will also change accordingly.*

*Note 2: The default IP address is 192.168.1.50.*

## 6.9 RS-232 and Telnet Commands

COMMAND	DESCRIPTION AND PARAMETERS
?	Show the full command list.
help	Show the full command list.
help N1	Show details about the specified command. <b>N1</b> = {Command name}
set factory default	Reset the unit to the factory defaults.
set factory ipconfig default	Reset the unit's network settings to the factory defaults.
get mac addr	Show the unit's MAC address.
get command ver	Show the unit's current command version.
get fw ver	Show the unit's current firmware version.
set power on	Turn the unit on.
set power off	Turn the unit off (stand-by mode).
get power	Show the unit's current power state.
set system reboot	Reboot the unit.
set keylock N1	Enable or disable the front panel key lock. Available values for <b>N1</b> : ON [Locked] OFF [Unlocked]
set uart 1 reset	Reset the unit's RS-232 settings to the factory defaults.

COMMAND	DESCRIPTION AND PARAMETERS
<b>set uart 1 baudrate N1</b>	Set the baud rate of the RS-232 port. Available values for <b>N1</b> : 4800 [4800 baud] 9600 [9600 baud] 19200 [19200 baud] 38400 [38400 baud] 57600 [57600 baud] 115200 [115200 baud]
<b>get uart 1 baudrate</b>	Show the current baud rate of the RS-232 port.
<b>set ip mode N1</b>	Set the IP address assignment mode. Available values for <b>N1</b> : 0 [Static IP mode] STATIC [Static IP mode] 1 [DHCP mode] DHCP [DHCP mode]
<b>get ip mode</b>	Show the current IP address assignment mode.
<b>get ipconfig</b>	Show the unit's current IP configuration information.
<b>set ipaddr N1</b>	Set the unit's static IP address. <b>N1</b> = X.X.X.X [X = 0 ~ 255]
<b>get ipaddr</b>	Show the unit's current IP address.
<b>set netmask N1</b>	Set the unit's static netmask. <b>N1</b> = X.X.X.X [X = 0 ~ 255]
<b>get netmask</b>	Show the unit's current netmask.
<b>set gateway N1</b>	Set the unit's static gateway address. <b>N1</b> = X.X.X.X [X = 0 ~ 255]



COMMAND	DESCRIPTION AND PARAMETERS
<b>get gateway</b>	Show the unit's current gateway address.
<b>set webgui password N1</b>	Set the WebGUI login password. N1 = {Password} [16 characters max]
<b>get webgui password</b>	Show the current WebGUI login password.
<b>set telnet port N1</b>	Set the unit's Telnet port. N1 = 1~65535 [Telnet port]
<b>get telnet port</b>	Show the unit's current Telnet access port.
<b>set in N1 name N2</b>	Set the name of the specified input. N1 = 1 ~ 4 [Input port] N2 = {Name} [32 characters max]
<b>get in N1 name</b>	Show the current name of the specified input. N1 = 1 ~ 4 [Input port]
<b>get in name list</b>	List the names of all inputs on the unit.
<b>set out N1 name N2</b>	Set the name of the specified output. N1 = A ~ D [Output port] N2 = {Name} [32 characters max]
<b>get out N1 name</b>	Show the name of the specified output N1 = A ~ D [Output port]
<b>get out name list</b>	List the names of all outputs on the unit.
<b>set out N1 route N2</b>	Route the specified input to the specified output. N1 = A ~ D [Output port] N2 = 1 ~ 4 [Input port]

COMMAND	DESCRIPTION AND PARAMETERS
get out N1 route	Show the current input routed to the specified output. <b>N1</b> = A ~ D [Output port]
set out N1 4k2k downscale mode N2	Enable/disable the 4K to 1080p downscale mode used by the specified output and set the behavior to use when enabled. <b>N1</b> = A ~ D [Output Port] Available values for <b>N2</b> : 0 [Bypass] 1 [Auto] 2 [Force 1080p] <i>Note: 1080p downscaling is only available on outputs A &amp; C.</i>
get out N1 4k2k downscale mode	Show the current 4K to 1080p downscale mode setting.
set ir in channel N1	Set the channel for the IR input to use. <b>N1</b> = 0 ~ 15 [IR channel]
get ir in channel	Show the current channel used by the IR input.
set ir in custom code N1	Set the custom code (in ASCII hex) used by the IR input. <b>N1</b> = {Code} [ASCII hex]
get ir in custom code	Show the current custom code used by the IR input.
get in type list	List the port type of all inputs on the unit.
get out type list	List the port type of all outputs on the unit.

COMMAND	DESCRIPTION AND PARAMETERS
set out route N1N2,N1N2,...	Set multiple input/output routes simultaneously.  N1 = A ~ D [Output port] N2 = 1 ~ 4 [Input port]
get out route N1,N1,...	Show the current routing assignments for all specified outputs.  N1 = A ~ D [Output port]
set all out route N1	Route the specified input to all outputs.  N1 = 1 ~ 4 [Input port]
get all out route	Show the current routing for all outputs.
set current route to preset N1	Save all current routing assignments to the specified preset.  N1 = 1 ~ 8 [Preset number]
set route preset N1	Activate the routing assignments saved in the specified preset.  N1 = 1 ~ 8 [Preset number]
get preset N1 list	List the routing assignments stored in the specified preset.  N1 = 1 ~ 8 [Preset number]
set route preset N1 name N2	Set a name for the specified preset.  N1 = 1 ~ 8 [Preset number] N2 = {Name} [32 characters max]
get route preset N1 name	Show the current name of the specified preset.  N1 = 1 ~ 8 [Preset number]
get in port number	Show the total number of inputs on the unit.

COMMAND	DESCRIPTION AND PARAMETERS
<b>get out port number</b>	Show the total number of outputs on the unit.
<b>set all in edid mode N1</b>	Select the EDID management mode to use (All or Appoint) for all inputs.  Available values for <b>N1</b> :  ON [All mode] OFF [Appoint mode]
<b>get all in edid mode</b>	Show the current EDID management mode used by all inputs.
<b>set all in edid N1</b>	Set the EDID to use when the "All" EDID mode is active.  Available values for <b>N1</b> :  1 [FHD/2CH] 2 [FHD/MCH] 3 [UHD/2CH] 4 [UHD/MCH] 5 [UHD+/2CH] 6 [UHD+/MCH] 7 [Sink A EDID] 8 [Sink B EDID] 9 [Sink C EDID] 10 [Sink D EDID] 11 [User 1 EDID] 12 [User 2 EDID] 13 [User 3 EDID] 14 [User 4 EDID]
<b>get all in edid</b>	Show the current EDID used by the "All" EDID mode.

COMMAND	DESCRIPTION AND PARAMETERS																												
get all in edid list	List the EDIDs assigned to all inputs.																												
set in N1 edid N2	<p>Set the EDID to use on the specified input in "Appoint" mode.</p> <p><b>N1</b> = 1 ~ 4 [Input port]</p> <p>Available values for <b>N2</b>:</p> <table data-bbox="468 421 962 1046"> <tr><td>1</td><td>[FHD/2CH]</td></tr> <tr><td>2</td><td>[FHD/MCH]</td></tr> <tr><td>3</td><td>[UHD/2CH]</td></tr> <tr><td>4</td><td>[UHD/MCH]</td></tr> <tr><td>5</td><td>[UHD+/2CH]</td></tr> <tr><td>6</td><td>[UHD+/MCH]</td></tr> <tr><td>7</td><td>[Sink A EDID]</td></tr> <tr><td>8</td><td>[Sink B EDID]</td></tr> <tr><td>9</td><td>[Sink C EDID]</td></tr> <tr><td>10</td><td>[Sink D EDID]</td></tr> <tr><td>11</td><td>[User 1 EDID]</td></tr> <tr><td>12</td><td>[User 2 EDID]</td></tr> <tr><td>13</td><td>[User 3 EDID]</td></tr> <tr><td>14</td><td>[User 4 EDID]</td></tr> </table>	1	[FHD/2CH]	2	[FHD/MCH]	3	[UHD/2CH]	4	[UHD/MCH]	5	[UHD+/2CH]	6	[UHD+/MCH]	7	[Sink A EDID]	8	[Sink B EDID]	9	[Sink C EDID]	10	[Sink D EDID]	11	[User 1 EDID]	12	[User 2 EDID]	13	[User 3 EDID]	14	[User 4 EDID]
1	[FHD/2CH]																												
2	[FHD/MCH]																												
3	[UHD/2CH]																												
4	[UHD/MCH]																												
5	[UHD+/2CH]																												
6	[UHD+/MCH]																												
7	[Sink A EDID]																												
8	[Sink B EDID]																												
9	[Sink C EDID]																												
10	[Sink D EDID]																												
11	[User 1 EDID]																												
12	[User 2 EDID]																												
13	[User 3 EDID]																												
14	[User 4 EDID]																												
get in N1 edid	<p>Show the EDID currently being used on the specified input in "Appoint" mode.</p> <p><b>N1</b> = 1 ~ 4 [Input port]</p>																												
get in edid list	List all available EDID selections.																												
set edid N1 name N2	<p>Set the name for the specified EDID. (Only User EDIDs may be renamed)</p> <p><b>N1</b> = 1 ~ 4 [User EDID]</p> <p><b>N2</b> = {Name} [32 characters max]</p>																												

COMMAND	DESCRIPTION AND PARAMETERS
get edid N1 name	Show the name for the specified User EDID. <b>N1</b> = 1 ~ 4 [User EDID]
set user N1 edid data N2	Upload a new EDID (in HEX format) for use as the specified User EDID. <b>N1</b> = 1 ~ 4 [User EDID] <b>N2</b> = {EDID data} [Comma delimited hex pairs]
get user N1 edid data	Show the current contents of the specified User EDID as HEX data. <b>N1</b> = 1 ~ 4 [User EDID]
get sink N1 edid data	Show the EDID from the display connected to the specified output as HEX data. <b>N1</b> = A ~ D [Output port]
get in N1 edid data	Show the EDID currently used by the specified input as HEX data. <b>N1</b> = 1 ~ 4 [Input port]
get internal N1 edid data	Show the specified Internal EDID as HEX data. <b>N1</b> = 1 ~ 6 [Internal EDID]
set in N1 hdcp mode N2	Set the HDCP behavior of the specified input. <b>N1</b> = 1 ~ 4 [Input port] Available values for <b>N2</b> : 0 [HDCP disabled] 1 [Follow source] 2 [Follow display]

COMMAND	DESCRIPTION AND PARAMETERS
<b>get in N1 hdcp mode</b>	Show the current HDCP behavior used by the specified input. <b>N1</b> = 1 ~ 4 [Input port]
<b>get in N1 hdcp status</b>	Show the current HDCP status of the specified input. <b>N1</b> = 1 ~ 4 [Input port] Available response values: 0 [No HDCP] 1 [HDCP 1.x] 2 [HDCP 2.2] 3 [HDCP 1.x failed] 4 [HDCP 2.x failed]
<b>set pattern N1 timing N2</b>	Set the test pattern's resolution for the specified output. <b>N1</b> = A ~ D [Output port] Available values for <b>N2</b> : 1 [480p60] 2 [576p50] 3 [720p60] 4 [720p50] 5 [1080p24] 6 [1080p25] 7 [1080p30] 8 [720p25] 9 [720p30] 10 [1080p60] 11 [1080p50] 12 [720p100]

COMMAND	DESCRIPTION AND PARAMETERS
set pattern N1 timing N2	13 [720p120]
	14 [1080p120]
	15 [1080p100]
	16 [2160p24]
	17 [2160p25]
	18 [2160p30]
	19 [2160p24 DCI]
	20 [2160p25 DCI]
	21 [2160p30 DCI]
	22 [2160p50]
23 [2160p60]	
get pattern N1 timing	Show the test pattern's current resolution for the specified output. N1 = A ~ D [Output port]
get pattern timing list	List all available test pattern output resolutions with their local index numbers.
set pattern N1 mode N2	Enable or disable the test pattern on the specified output. N1 = A ~ D [Output port]
	Available values for N2:
	ON [Enabled]
	OFF [Disabled]
get pattern N1 mode	Show the current state of the specified output's test pattern mode. N1 = A ~ D [Output port]





COMMAND	DESCRIPTION AND PARAMETERS
<b>set out N1 osd timeout N2</b>	Set the OSD's timeout value for the specified output (in seconds).  <b>N1</b> = A ~ D [Output port]  Available values for <b>N2</b> : 0 [Always on] 1 ~ 60 [Timeout in seconds]
<b>get out N1 osd timeout</b>	Show the current OSD timeout value for the specified output.  <b>N1</b> = A ~ D [Output port]
<b>set out N1 banner text N2</b>	Set the OSD banner text to use on the specified output.  <b>N1</b> = A ~ D [Output port] <b>N2</b> = {Text} [64 characters max]
<b>get out N1 banner text</b>	Show the current OSD banner text used by the specified output.  <b>N1</b> = A ~ D [Output port]
<b>get out N1 banner text length</b>	Show the maximum allowable character length for the OSD information banner.

COMMAND	DESCRIPTION AND PARAMETERS
<b>set out N1 osd banner location N2</b>	<p>Set the OSD banner location on the specified output.</p> <p><b>N1</b> = A ~ D [Output port]</p> <p>Available values for <b>N2</b>:</p> <p>0 [Top left]</p> <p>1 [Middle left]</p> <p>2 [Bottom left]</p> <p>3 [Top right]</p> <p>4 [Middle right]</p> <p>5 [Bottom right]</p> <p>6 [Top center]</p> <p>7 [Middle center]</p> <p>8 [Bottom center]</p>
<b>get out N1 osd banner location</b>	<p>Show the current OSD banner location on the specified output.</p> <p><b>N1</b> = A ~ D [Output port]</p>
<b>get in N1 sync status</b>	<p>Show the current sync state of the specified input.</p> <p><b>N1</b> = 1 ~ 4 [Input port]</p> <p>Available response values:</p> <p>0 [No sync]</p> <p>1 [Active sync]</p>
<b>get out N1 sync status</b>	<p>Show the current sync state of the specified output.</p> <p><b>N1</b> = A ~ D [Output port]</p> <p>Available response values:</p> <p>0 [No sync]</p> <p>1 [Active sync]</p>

COMMAND	DESCRIPTION AND PARAMETERS
<b>set feedback broadcast N1</b>	Enable or disable the broadcast of console command feedback.  Available values for <b>N1</b> :  ON [Enabled] OFF [Disabled]
<b>get feedback broadcast</b>	Show the current console command feedback broadcast state.

*Note: Commands will not be executed unless followed by a carriage return. Commands are not case-sensitive.*

## 7. CONNECTION DIAGRAM

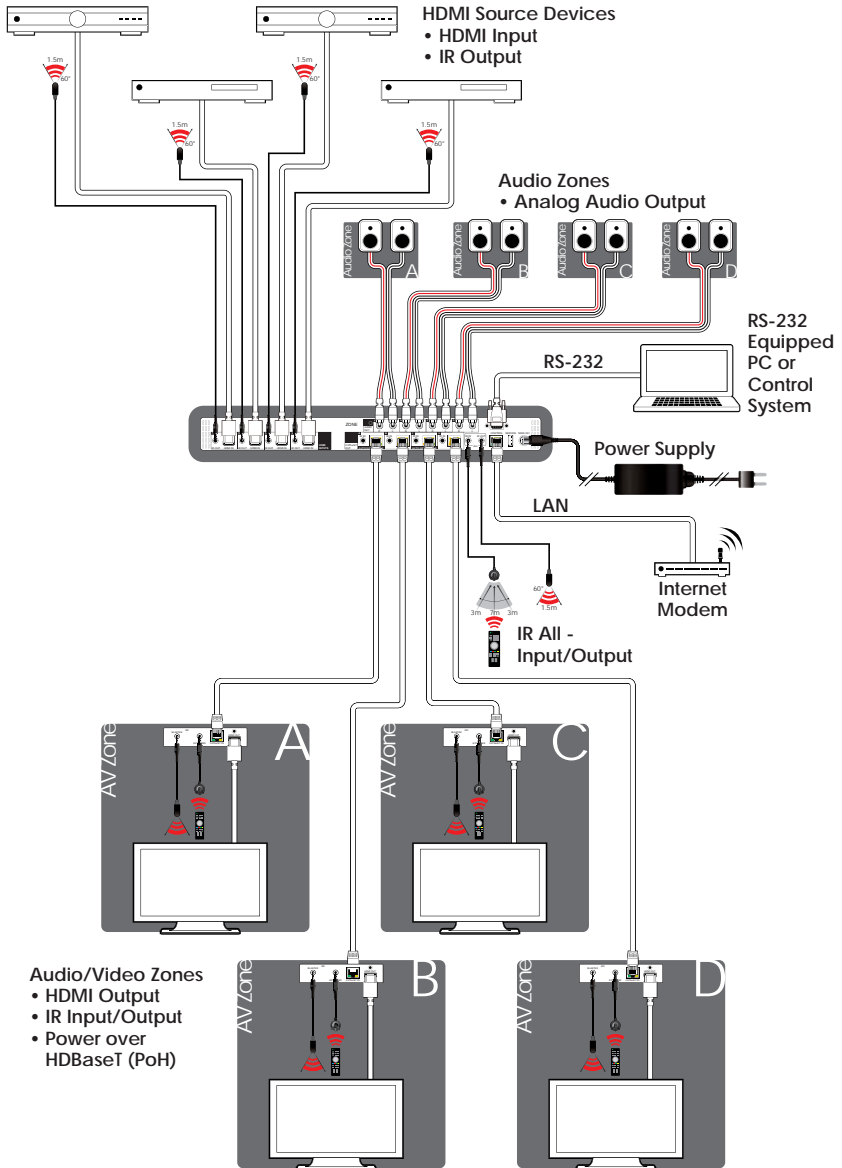



## 8. SPECIFICATIONS

### 8.1 Technical Specifications

<b>HDMI Bandwidth</b>	18Gbps
<b>HDBaseT Bandwidth</b>	10.2Gbps
<b>Input Ports</b>	4×HDMI (Type-A)
<b>Output Port</b>	4×HDBaseT (RJ-45) 4×Stereo Audio (RCA Pairs)
<b>Pass-through Ports</b>	5×IR Extender (3.5mm) 5×IR Blaster (3.5mm)
<b>Control Ports</b>	1×RS-232 (DE-9) 1×IP Control (RJ-45)
<b>Service Port</b>	1×USB 2.0 (Type A)
<b>IR Frequency</b>	30 – 50kHz (30 – 60kHz under ideal conditions)
<b>Baud Rate</b>	19200
<b>Power Supply</b>	24V/6.25A DC (US/EU standards, CE/FCC/UL certified)
<b>ESD Protection (HBM)</b>	±8kV (Air Discharge) ±4kV (Contact Discharge)
<b>Dimensions (W×H×D)</b>	438mm×44mm×270mm [Case Only] 482mm×49mm×279mm [All Inclusive]
<b>Weight</b>	3.642kg
<b>Chassis Material</b>	Metal (Steel)
<b>Chassis Color</b>	Black
<b>Operating Temperature</b>	0°C – 40°C/32°F – 104°F
<b>Storage Temperature</b>	-20°C – 60°C/-4°F – 140°F
<b>Relative Humidity</b>	20 – 90% RH (Non-condensing)
<b>Power Consumption</b>	92W

## 8.2 Video Specifications

Supported Resolutions (Hz)	Input	Output
	HDMI	HDBaseT
720×400p@70/85	✓	✓
640×480p@60/72/75/85	✓	✓
720×480i@60	✓	✓
720×480p@60	✓	✓
720×576i@50	✓	✓
720×576p@50	✓	✓
800×600p@56/60/72/75/85	✓	✓
848×480p@60	✓	✓
1024×768p@60/70/75/85	✓	✓
1152×864p@75	✓	✓
1280×720p@50/60	✓	✓
1280×768p@60/75/85	✓	✓
1280×800p@60/75/85	✓	✓
1280×960p@60/85	✓	✓
1280×1024p@60/75/85	✓	✓
1360×768p@60	✓	✓
1366×768p@60	✓	✓
1400×1050p@60	✓	✓
1440×900p@60/75	✓	✓
1600×900p@60RB	✓	✓
1600×1200p@60	✓	✓
1680×1050p@60	✓	✓
1920×1080i@50/60	✓	✓
1920×1080p@24/25/30	✓	✓
1920×1080p@50/60	✓	✓
1920×1200p@60RB	✓	✓

Supported Resolutions (Hz)	Input	Output
	HDMI	HDBaseT
2560×1440p@60RB	x	x
2560×1600p@60RB	x	x
2048×1080p@24/25/30	✓	✓
2048×1080p@50/60	✓	✓
3840×2160p@24/25/30	✓	✓
3840×2160p@50/60 (4:2:0)	✓	✓
3840×2160p@24, HDR10	✓	AVLC
3840×2160p@50/60 (4:2:0), HDR10	✓	AVLC
3840×2160p@50/60	✓	AVLC
4096×2160p@24/25/30	✓	✓
4096×2160p@50/60 (4:2:0)	✓	✓
4096×2160p@24, HDR10	x	x
4096×2160p@50/60 (4:2:0), HDR10	x	x
4096×2160p@50/60	x	x



## 8.3 Audio Specifications

### 8.3.1 Digital Audio

HDMI Input/Output	
LPCM	
Max Channels	8 Channels
Sampling Rate (kHz)	32, 44.1, 48, 88.2, 96, 176.4, 192
Bitstream	
Supported Formats	Standard & High-Definition

### 8.3.2 Analog Audio

Analog Output	
Max Audio Level	2Vrms
THD+N	< -80dB@0dBFS 1kHz (A-wt)
SNR	> 100dB@0dBFS
Frequency Response	< ±0.5dB@20Hz~20kHz
Crosstalk	< -90dB@10kHz
Impedance	470Ω
Type	Unbalanced

## 8.4 Cable Specifications

Cable Length	1080p		4K30	4K60
	8-bit	12-bit	(4:4:4) 8-bit	(4:4:4) 8-bit
High Speed HDMI Cable				
HDMI Input	15m	10m	5m	3m
Ethernet Cable				
Cat.5e/6	60m		35m	
Cat.6a/7	70m		40m	



### Bandwidth Category Examples:

- **1080p (FHD Video)**
  - Up to 1080p@60Hz, 12-bit color
  - Data rates lower than 5.3Gbps or below 225MHz TMDS clock
- **4K30 (UHD Video)**
  - 4K@24/25/30Hz & 4K@50/60Hz (4:2:0), 8-bit color
  - 4K@50/60Hz (4:4:4, 8-bit) with AVLC active
  - Data rates higher than 5.3Gbps or above 225MHz TMDS clock but below 10.2Gbps
- **4K60 (UHD+ Video)**
  - 4K@50/60Hz (4:4:4, 8-bit), AVLC required over HDBaseT
  - 4K@50/60Hz (4:2:0, 10-bit HDR), AVLC required over HDBaseT
  - Data rates higher than 10.2Gbps

## 8.5 HDBaseT Features

HDBaseT Feature Set	Transmitter
Video & Audio Extension	Supported
LAN Extension	Unsupported
Send power to Receiver	Supported (PoH)
Accept power from Receiver	Unsupported
IR Extension	Supported
RS-232 Extension	Unsupported
USB 2.0 Extension	Unsupported

## 9. ACRONYMS

ACRONYM	COMPLETE TERM
ASCII	American Standard Code for Information Interchange
AVLC	Adaptive Visually Lossless Compression
Cat.5e	Enhanced Category 5 cable
Cat.6	Category 6 cable
Cat.6a	Augmented Category 6 cable
Cat.7	Category 7 cable
CLI	Command-Line Interface
DAC	Digital-to-Analog Converter
DHCP	Dynamic Host Configuration Protocol
DVI	Digital Visual Interface
EDID	Extended Display Identification Data
GUI	Graphical User Interface
HD	High-Definition
HDBT	HDBaseT
HDCP	High-bandwidth Digital Content Protection
HDMI	High-Definition Multimedia Interface
HDR	High Dynamic Range
HDTV	High-Definition Television
IP	Internet Protocol
IR	Infrared
LAN	Local Area Network
LED	Light-Emitting Diode
LPCM	Linear Pulse-Code Modulation
MAC	Media Access Control
OLED	Organic Light-Emitting Diode
OSD	On-Screen Display
PD	Powered Device

ACRONYM	COMPLETE TERM
PoH	Power over HDBaseT
PSE	Power Sourcing Equipment
SNR	Signal-to-Noise Ratio
TCP	Transmission Control Protocol
THD+N	Total Harmonic Distortion plus Noise
UHD	Ultra-High-Definition (10.2Gbps)
UHD+	Ultra-High-Definition Plus (18Gbps)
UHDTV	Ultra-High-Definition Television
USB	Universal Serial Bus
WUXGA (RB)	Widescreen Ultra Extended Graphics Array (Reduced Blanking)





CYPRESS TECHNOLOGY CO., LTD.

[www.cypress.com.tw](http://www.cypress.com.tw)