



CH-2603RX

HDMI/HDBaseT/USB to HDMI Receiver



Operation Manual

DISCLAIMERS

The information in this manual has been carefully checked and is believed to be accurate. Cypress Technology assumes no responsibility for any infringements of patents or other rights of third parties which may result from its use.

Cypress Technology assumes no responsibility for any inaccuracies that may be contained in this document. Cypress also makes no commitment to update or to keep current the information contained in this document.

Cypress Technology reserves the right to make improvements to this document and/or product at any time and without notice.

COPYRIGHT NOTICE

No part of this document may be reproduced, transmitted, transcribed, stored in a retrieval system, or any of its part translated into any language or computer file, in any form or by any means—electronic, mechanical, magnetic, optical, chemical, manual, or otherwise—without express written permission and consent from Cypress Technology.

© Copyright 2018 by Cypress Technology.

All Rights Reserved.

TRADEMARK ACKNOWLEDGMENTS

All products or service names mentioned in this document are trademarks of the companies with which they are associated.





SAFETY PRECAUTIONS

Please read all instructions before attempting to unpack, install or operate this equipment and before connecting the power supply. Please keep the following in mind as you unpack and install this equipment:

- Always follow basic safety precautions to reduce the risk of fire, electrical shock and injury to persons.
- To prevent fire or shock hazard, do not expose the unit to rain, moisture or install this product near water.
- Never spill liquid of any kind on or into this product.
- Never push an object of any kind into this product through any openings or empty slots in the unit, as you may damage parts inside the unit.
- Do not attach the power supply cabling to building surfaces.
- Use only the supplied power supply unit (PSU). Do not use the PSU if it is damaged.
- Do not allow anything to rest on the power cabling or allow any weight to be placed upon it or any person walk on it.
- To protect the unit from overheating, do not block any vents or openings in the unit housing that provide ventilation and allow for sufficient space for air to circulate around the unit.
- Please completely disconnect the power when the unit is not in use to avoid wasting electricity.

VERSION HISTORY

REV.	DATE	SUMMARY OF CHANGE
RDV1	2019/04/29	Preliminary release



CONTENTS

1. Introduction	1
2. Applications	1
3. Package Contents	2
4. System Requirements	2
5. Features	3
6. Operation Controls and Functions	4
6.1 Front Panel	4
6.2 Rear Panel.....	5
6.3 IR Cable Pinouts	6
6.4 RS-232 Pinout and Defaults	6
6.5 WebGUI Control.....	7
6.5.1 Video Select Tab.....	9
6.5.2 EDID Tab.....	11
6.5.3 HDCP Tab.....	13
6.5.4 USB Tab.....	14
6.5.5 Audio Tab	15
6.5.6 System Tab.....	16
6.6 Telnet Control	17
6.7 RS-232 and Telnet Commands	18
7. Connection Diagram	29
8. Specifications	30
8.1 Technical Specifications	30
8.2 Video Specifications	32
8.3 Audio Specifications	34
8.3.1 Digital Audio	34
8.3.2 Analog Audio	34
8.4 Cable Specifications	35
8.5 HDBaseT Features.....	36
9. Acronyms	37



1. INTRODUCTION

This HDBaseT 2.0 Receiver is designed for use in environments needing a wide range of flexibility when it comes to inputs, outputs, and control. With a 2 by 2 matrix arrangement of HDBaseT & HDMI inputs and dual HDMI outputs this Receiver can handle a variety of source routing scenarios. The HDMI input and outputs support resolutions up to a maximum of 4K@60Hz (4:4:4, 8-bit) while the HDBaseT input supports resolutions up to a maximum of 4K@60Hz (YUV 4:2:0, 8-bit). A balanced analog stereo audio breakout is also provided (LPCM 2.0 sources only) allowing for professional local powered speakers to be easily added to the system. The HDBaseT input not only supports video and audio but also bi-directional Ethernet, RS-232, USB, and IR.

When paired with this unit's standard Transmitter, up to 3 switchable USB 2.0 host (Type B) connections are available (2 on the Transmitter, 1 on the Receiver) which connect to 6 USB 2.0 (Type A) device ports (3 on the Transmitter, 3 on the Receiver) for a multi-source, bi-directional, and highly flexible KVM configuration (Note: Only 1 USB host may be active at a time).

This Receiver (PSE) can provide PoH (Power over HDBaseT) power to the connected HDBaseT Transmitter (PD) (compatible Transmitters only), allowing for greater flexibility within different installation scenarios. This unit is controllable via front-panel controls, WebGUI, Telnet, and RS-232.

2. APPLICATIONS

- Lecture room display and control
- Showroom display and control
- Meeting room presentation and control
- Classroom display and control

3. PACKAGE CONTENTS

- 1×HDMI/HDBaseT/USB to HDMI Receiver
- 1×24V/3.75A DC Power Adapter
- 1×3.5mm to IR Blaster Cable
- 1×3.5mm to IR Extender Cable
- 1×Shockproof Feet (Set of 4)
- 1×Operation Manual
- 1x power cord
- 1x3-pin terminal block
- 1x5-pin terminal block

4. SYSTEM REQUIREMENTS

- HDMI source equipment such as a media player, video game console, or set-top box.
- A compatible HDBaseT transmitter with PoH (PD) support is recommended.
- HDMI receiving equipment such as HDTVs, monitors or audio amplifiers.
- The use of Premium High Speed HDMI cables, and industry standard Cat.6, Cat.6a or Cat.7, is highly recommended.



5. FEATURES

- HDMI input and output with 3D & 4K video support (18Gbps)
- HDCP 1.x & 2.2 compliant
- HDBaseT 2.0 compatible
- Selectable HDMI and HDBaseT inputs
- HDMI input supports resolutions up to 4K@60Hz (4:4:4, 8-bit)
- HDBaseT input supports resolutions up to 4K@60Hz (YUV 4:2:0, 8-bit)
- HDMI outputs support resolutions up to 4K@60Hz (4:4:4, 8-bit)
- 2x2 matrix switching (both HDMI outputs are independent)
- Supported HDBaseT features: HD video and audio, 100BaseT Ethernet, PoH, and control (bi-directional IR/RS-232/USB pass-through)
- Supports pass-through of 8 channel LPCM, Bitstream & HD Bitstream audio formats
- Balanced analog stereo audio breakout
- Flexible USB host selection using front panel buttons
- Multiple USB hosts may be connected at once (up to 3 total, between the Tx and a compatible Rx unit) with a single selected host active at a time
- Supports providing PoH power from Receiver (PSE) to Transmitter (PD) (compatible Transmitters only)
- Controllable via front panel buttons, WebGUI, Telnet, and RS-232

6. OPERATION CONTROLS AND FUNCTIONS

6.1 Front Panel

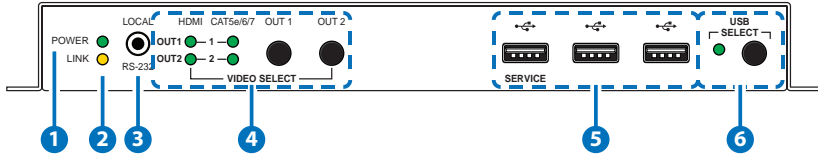

- 1 POWER LED:** This LED will illuminate to indicate the unit is on and receiving power.
- 2 LINK LED:** This LED will illuminate solidly when a live connection with a compatible Transmitter is active.
- 3 LOCAL RS-232 Port:** Connect directly to a PC, laptop, or other serial control device with a 3.5mm adapter cable to send RS-232 commands to control the unit.
- 4 OUT 1 Button & LEDs:** Press this button to toggle between the available inputs for HDMI output 1. The OUT 1 LED will illuminate to indicate which source is currently selected.
OUT 2 Button & LEDs: Press this button to toggle between the available inputs for HDMI output 2. The OUT 2 LED will illuminate to indicate which source is currently selected.
- 5 USB Device Ports (Type A):** Connect directly to standard USB devices such as a mouse, keyboard or flash drive to extend their USB functionality to the currently active USB Host Port.
- 6 USB SELECT Button & LED:** Press this button to toggle between using the USB Host Port on the Receiver or the USB Host Ports on the connected Transmitter. The LED will illuminate when the USB Host Port on the Receiver is active. If the LED is off, then one of the USB Host Ports on the connected Transmitter is active.

Note: Changing the USB host will force the HDBaseT connection to briefly disconnect while it reconfigures. The connected host (PC, Laptop, etc.) may also take a moment to detect all available devices.

6.2 Rear Panel

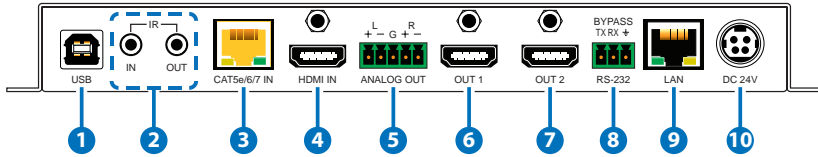

- 1 USB Host Port (Type B):** Connect directly to a standard USB host such as a PC or laptop to extend their USB functionality to all currently connected USB devices.

Note: Only one USB Host Port may be active at a time.

- 2 IR IN Port:** Connect to the provided IR Extender to receive IR control signals and extend them to devices connected to the other end of the HDBaseT connection. Ensure that the remote being used is within direct line-of-sight of the IR Extender.

IR OUT Port: Connect to the provided IR Blaster to transmit IR signals from the other end of the HDBaseT connection to devices within direct line-of-sight of the IR Blaster.

- 3 CAT5e/6/7 IN Port:** Connect to a compatible HDBaseT Transmitter with a single Cat.5e/6/7 cable for reception of all data signals. PoH will also be supplied to a connected compatible PD Transmitter.
- 4 HDMI IN Port:** Connect to HDMI source equipment such as a media player, game console, or set-top box.
- 5 ANALOG OUT Terminal Block:** Connect to powered speakers or an amplifier using a 5-pin terminal block for balanced stereo analog audio output.
- 6 HDMI OUT 1 Port:** Connect to an HDMI TV, monitor, or amplifier for digital video and audio output.
- 7 HDMI OUT 2 Port:** Connect to an HDMI TV, monitor, or amplifier for digital video and audio output.
- 8 BYPASS RS-232 Terminal Block:** Connect to a PC, laptop, or other serial control device with a 3-pin adapter cable for the extension of RS-232 signals to the Transmitter.
- 9 LAN Port:** Connect directly, or through a network switch, to your PC/laptop to control the unit via Telnet/WebGUI and to extend the network across the HDBaseT connection.

- 10 **DC 24V Port:** Plug the 24V DC power adapter into this port and connect it to an AC wall outlet for power.

6.3 IR Cable Pinouts

IR Blaster Cable

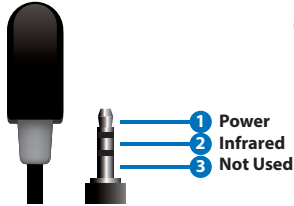

IR Extender Cable

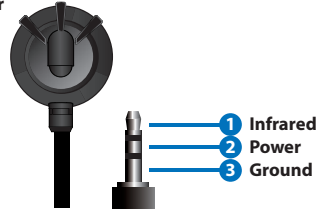

6.4 RS-232 Pinout and Defaults

Serial Port Default Settings	
Baud Rate	19200
Data Bits	8
Parity Bits	None
Stop Bits	1
Flow Control	None

3-pin Terminal Block

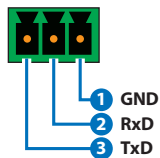

3.5mm to DE-9 Adapter Cable

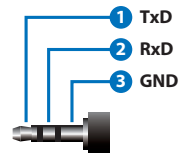

6.5 WebGUI Control

- **Device Discovery**

Please obtain the “Device Discovery” software from your authorized dealer and save it in a directory where you can easily find it.

Connect the unit and your PC/Laptop to the same active network and execute the “Device Discovery” software. Click on “Find Devices on Network” and a list of devices connected to the local network will show up indicating their current IP address.

Note: The unit's default IP address is 192.168.1.50.

Product Name	Description	IP Address	MAC Address

By clicking on one of the listed devices you will be presented with the network details of that particular device.

Product ID
Product Name
MAC Address 00:00:00:00:00
IP Address
Subnet Mask
Gateway IP
DNS
IP Mode Static
Web GUI Port Static
Telnet Port 0
S / N
Firmware Version
Hardware Version
Description
Web GUI [Web GUI](#)
Save Reboot

- 1) **IP Mode:** If you choose, you can alter the static IP network settings for the device, or switch the unit into DHCP mode to automatically obtain proper network settings from a local DHCP server. To switch to DHCP mode, please select DHCP from the IP mode drop-down, then click “Save” followed by “Reboot”.
- 2) **WebGUI Hotkey:** Once you are satisfied with the network settings, you may use them to connect via Telnet or WebGUI. The network information window provides a convenient link to launch the WebGUI directly.

- **WebGUI Overview**

After connecting to the WebGUI's address in a web browser, the login screen will appear. Please enter the appropriate user name and password then click "Submit" to log in.

Note: The default user name and password is "admin".



On the left side of the browser you will see the following menu tabs where all primary functions of the unit are controllable via the built in WebGUI. The individual functions will be introduced in the following sections.

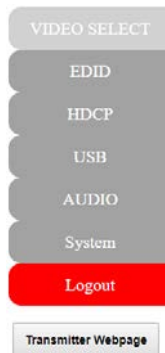

Clicking the red "Logout" tab will automatically log the currently connected user out of the WebGUI and return to login page. Clicking on the "Transmitter Webpage" button will open a new webpage showing the WebGUI for the connected Transmitter.

6.5.1 Video Select Tab

This tab provides A/V routing control, auto switch controls, and I/O renaming options.

To assign a new A/V route, please click the button of the Output you wish to route a source to on the left and then click on the button of the preferred Input port on the right. Selecting both Outputs simultaneously is possible.

As you select each button they will become yellow. The new route will become active immediately and the routing information displayed on the buttons will change accordingly.

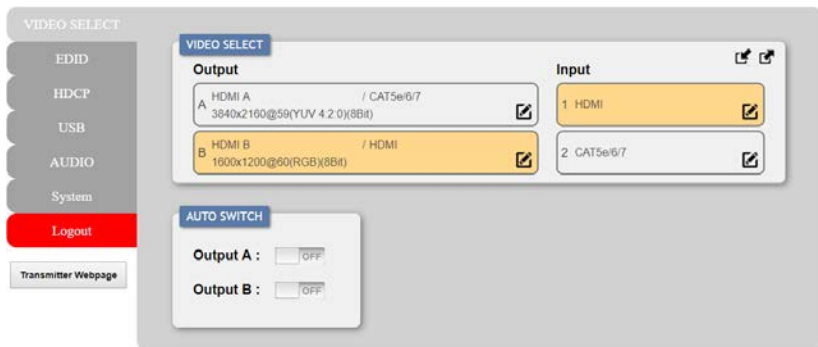

1) Video Select:

- **Output:** Buttons for selecting the Output (A or B) to route A/V Inputs to. Details about the Output names and currently selected Input are also displayed here. Clicking on the “edit” icon (✎) opens up the Edit Output window which allows for changing the Output's name.
- **Input:** Buttons for selecting the Input (1 through 2) to route to the selected Output. The current Input names are also displayed here. Clicking on the “edit” icon (✎) opens up the Edit Input window which allows for changing the Input's name.

- 2) **Auto Switch:** Auto switching may be enabled or disabled individually for each Output. Click on the On/Off slider to toggle the behavior of the selected Output.

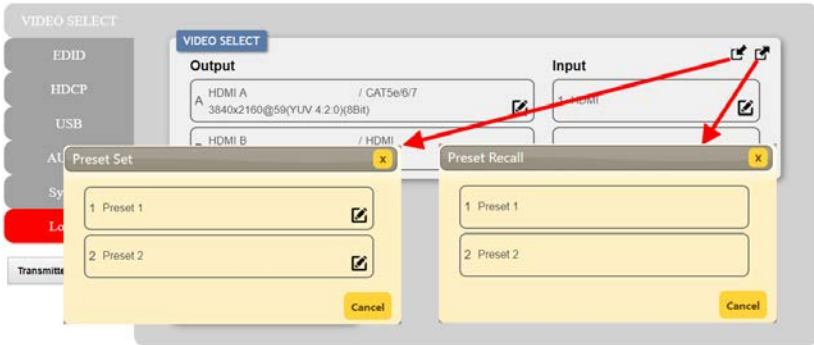

This unit can store up to two routing presets. Presets can be utilized to store multiple different routing states in advance for rapid, hassle-free, recall.

- 3) **Preset Set:** Once you have the routing set the way you like, you can click the “Preset Set” icon (📌) in the upper right corner of the tab to open the Preset Set window. Click on the preferred Preset button when you are ready to commit the preset to memory. You may also rename the preset at this stage by selecting the “edit” icon (✎).
- 4) **Preset Recall:** When you wish to load a previously stored preset, please click the “Preset Recall” icon (📌) and you will be presented with a choice of the 2 available presets. The preset will load immediately upon selecting the button..

6.5.2 EDID Tab

This tab provides the option of six standard EDIDs, two sink sourced EDIDs and two customer uploaded User EDIDs that can be assigned to either or both of the input ports.

VIDEO SELECT

- EDID
- HDCP
- USB
- AUDIO
- System
- Logout**
- Transmitter Webpage

EDID

Customer EDID Settings

1	User 1	Save Name	Download	Upload
2	User 2	Save Name	Download	Upload

Sink EDID Download

Select

Set EDID Input Content

1	HDMI UHD+ MCH
2	CAT5e/6/7 FHD 2CH

EDID Source

1	Internal 1 FHD 2CH
2	Internal 2 FHD MCH
3	Internal 3 UHD 2CH
4	Internal 4 UHD MCH
5	Internal 5 UHD+ 2CH
6	Internal 6 UHD+ MCH
7	User 1 User 1
8	User 2 User 2
9	Sink HDMI 1 Sink A
10	Sink HDMI 2 Sink B

1) Customer EDID Settings:

- **Save Name:** To modify the name of a User EDID, simply type the new name in the space provided and then click on the "Save Name" button to confirm the change.
- **Upload:** To upload a User EDID, press the "Upload" button next to the User EDID slot you wish to upload into. An EDID Upload window will appear, allowing you to locate and upload the preferred EDID file (*.bin format) from a local PC. Once the correct file has been selected, please click the "Upload" button in the window, and the file will be transferred to the unit.
- **Download:** To save an existing User EDID to your local PC, press the "Download" button next to the User EDID slot you wish to save. Depending on your browser settings you will either be asked where to save the downloaded file, or the file will be transferred to the default download location on your PC.

2) **Sink EDID Download:** To save the EDID from a connected display to your local PC, select the sink from the dropdown list then press the "Download" button. Depending on your browser settings you will either be asked where to save the downloaded file, or the file will be transferred to the default download location on your PC.

3) **Set EDID Input Content/EDID Source:** The Set EDID Input Content section allows for the assignment of a specific EDID to either Input port. Click on one or more input buttons on the left and then select the new EDID source to use from the choices on the right. The buttons will change color as you select them and the EDID change will occur immediately across all selected Inputs.

Note: In most cases, assigning a new EDID to an input will cause the affected input to briefly blink out while the source adapts to the new information.

This unit provides the following 6 default EDIDs:

Unit's Default EDIDs		
FHD/2CH	1920×1080p@60Hz (148MHz) & 8-bit color	LPCM 2.0
FHD/MCH	1920×1080p@60Hz (148MHz) & 8-bit color	LPCM 7.1 & Bitstream
UHD/2CH	3840×2160p@30Hz (297MHz) & Deep Color (8/10/12-bit)	LPCM 2.0
UHD/MCH	3840×2160p@30Hz (297MHz) & Deep Color (8/10/12-bit)	LPCM 7.1 & Bitstream
UHD+/2CH	3840×2160p@60Hz (594MHz) & Deep Color (8/10/12-bit)	LPCM 2.0
UHD+/MCH	3840×2160p@60Hz (594MHz) & Deep Color (8/10/12-bit)	LPCM 7.1 & Bitstream

Note: In some rare cases it is possible for custom or external EDIDs to cause compatibility issues with certain sources. If this happens, it is recommended to switch to one of the 6 default EDIDs for maximum compatibility.

6.5.3 HDCP Tab

This tab provides the option of three HDCP operational modes that can be assigned to any of the input ports.

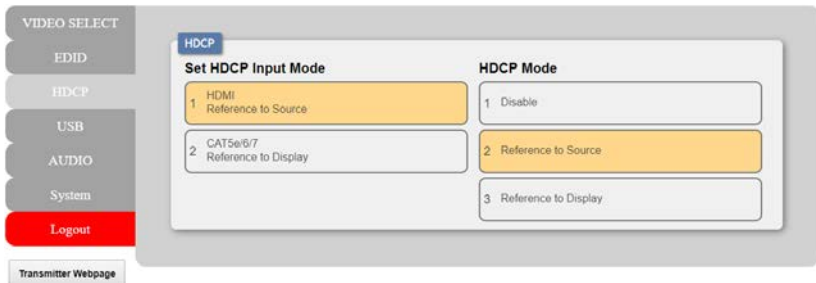

- 1) **Set HDCP Input Mode/HDCP Mode:** The HDCP Input Mode section allows for the assignment of a specific HDCP behavior to any Input port. Click on one or more input buttons on the left and then select the new HDCP mode to use from the choices on the right. The

buttons will change color as you select them and the change in HDCP behavior will occur immediately across all selected Inputs. “Reference to Source” will make the input operate using the HDCP version required by the connected source. “Reference to Display” will limit the input to only accept the HDCP version supported by the connected display. Selecting “Disable” will completely disable HDCP support on that input.

6.5.4 USB Tab

This tab provides a way to select which USB Host Port (USB Type B) is currently active.

Note: Changing the USB host will force the HDBaseT connection to briefly disconnect while it reconfigures. The connected host (PC, Laptop, etc.) may also take a moment to detect all available devices.

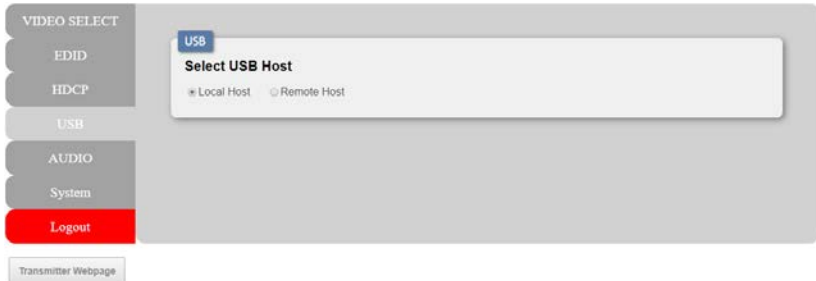

- 1) **Set USB Mode:** Select the preferred USB Host Port, from the displayed selection, to use as the currently active connection. The change will occur immediately and all USB Device Ports (USB Type A) on the Transmitter and Receiver will connect to the new host.

Note: When "Remote Host" is selected, Host Port 1 on the Transmitter will become active. To select Host Port 2 on the Transmitter, please use the Transmitter's WebGUI.

6.5.5 Audio Tab

This tab provides control over the volume level of the balanced analog audio output.

Note: HDMI audio output is always a direct pass-through from the selected source and is not affected by the controls on this tab.

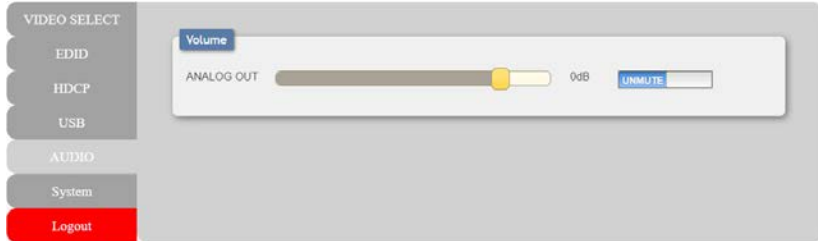

- 1) **Volume:** Allows the adjustment of the balanced analog output's volume level. The available adjustment range is -103 to +24 dB. The analog output may also be muted or unmuted using the toggle switch.

Note: The analog output can only support LPCM 2.0 sources. Bitstream sources will be automatically muted.

6.5.6 System Tab

This tab provides system information, network configuration options, system configuration resets, and firmware update functions.

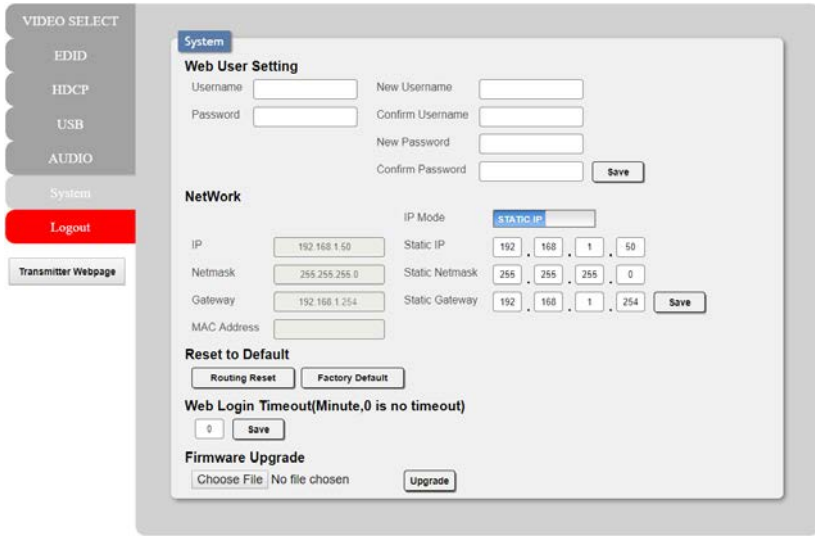

1) System:

- Web User Setting:** This section provides a way to change the password for the Administrator account. Click on “Save” to confirm and activate any changes made to these settings.
Note: The default username and password is “admin”.
- Network:** The unit’s IP mode may be switched between Static IP or DHCP. In Static IP mode the IP, netmask and gateway addresses may be manually set. When in DHCP mode, the unit will attempt to connect to a local DHCP server and obtain IP, netmask and gateway addresses automatically. Please press “Save” after making any changes to the IP configuration or mode.

Note: If the IP address is changed then the IP address required for WebGUI/Telnet access will also change accordingly.

- Reset to Default:** Press the “Routing Reset” button to reset all I/O routing configurations to the factory defaults. Press the “Factory Reset” button to reset the unit to its factory default state. After the factory reset is complete, the unit will reboot automatically.

- **Web Login Timeout:** Select the length of time to wait before logging the user out of the WebGUI due to inactivity. Available range is from 1 to 65535 minutes. Setting this to 0 will disable the inactivity timeout.
- **Firmware Upgrade:** To update the unit's firmware, click the "Choose File" button to open the file selection window and then select the firmware update file (*.bin format) located on your local PC. After selecting the file, click the "Upgrade" button to begin the firmware update process. After the upgrade is complete, the unit will reboot automatically.

6.6 Telnet Control

Before attempting to use Telnet control, please ensure that both the unit and the PC are connected to the same active networks.

To Access the Command Line Interface (CLI)	
Windows 7	Click Start , type "cmd" in the search field, and press Enter .
Windows XP	Click Start > Run , type "cmd", and press Enter .
Mac OS X	Click Go > Applications > Utilities > Terminal .

Once in the Command Line Interface (CLI) type "**telnet**" followed by the IP address of the unit (and the port number if it is non-standard) and then hit "**Enter**". This will connect us to the unit we wish to control.

```
Microsoft Windows [Version 6.1.7601]
Copyright (c) 2009 Microsoft Corporation. All rights reserved.
C:\Users\Administrator>telnet 192.168.1.50 23
```

Note If the IP address is changed then the IP address required for Telnet access will also change accordingly.

Note 2: The default IP address is 192.168.1.50.

6.7 RS-232 and Telnet Commands

COMMAND	
Description and Parameters	
help↵	Show the full command list.
?↵	Show the full command list.
help N1↵	Show help details about command N1. N1 = {Command}
get model name↵	Show the unit's model name.
get fw ver↵	Show the unit's current firmware version.
set factory default↵	Reset all settings to the factory defaults.
set factory ipconfig default↵	Reset the IP configuration to the factory defaults.
set factory out route default↵	Reset output routing to the factory defaults.
set system reboot↵	Reboot the unit.
set ip mode N1↵	Set the IP address assignment mode. Available values for N1: 0 [Static IP Mode] 1 [DHCP Mode]
get ip mode↵	Show the current IP address assignment mode.

COMMAND	
Description and Parameters	
get ipconfig ↵	
	Show the unit's current IP configuration information.
set ip addr N1 ↵	
	Set the unit's static IP address.
N1 = X.X.X.X	[X = 0 ~ 255]
get ip addr ↵	
	Show the unit's current IP address.
set netmask N1 ↵	
	Set the unit's static netmask.
N1 = X.X.X.X	[X = 0 ~ 255]
get netmask ↵	
	Show the unit's current netmask.
set gateway N1 ↵	
	Set the unit's static gateway address.
N1 = X.X.X.X	[X = 0 ~ 255]
get gateway ↵	
	Show the unit's current gateway address.
set webgui username N1 ↵	
	Set the WebGUI administrator user name.
N1 = {Name}	[16 characters max]
get webgui username ↵	
	Show the current WebGUI administrator user name
set webgui password N1 ↵	
	Set WebGUI administrator password.
N1 = {password}	[16 characters max]
get webgui password ↵	
	Show the current WebGUI administrator password.

COMMAND	
Description and Parameters	
set webgui login timeout N1↵	
Set the WebGUI inactivity timeout value.	
Available values for N1 :	
0	[No timeout]
1 ~ 65535	[Timeout in minutes]
get webgui login timeout↵	
Show the current WebGUI inactivity timeout value.	
set in N1 name N2↵	
Set the name of the specified input.	
N1 = 1 ~ 2	[Input port]
N2 = {Name}	[16 characters max]
get in N1 name↵	
Show the current name of the specified input.	
N1 = 1 ~ 2	[Input port]
set out N1 name N2↵	
Set the name of the specified output.	
N1 = A ~ B	[Output port]
N2 = {Name}	[16 characters max]
get out N1 name↵	
Show the name of the specified output.	
N1 = A ~ B	[Output port]
set out N1 route N2↵	
Set the routing of the specified output.	
N1 = A ~ B	[Output port]
N2 = 1 ~ 2	[Input port]

COMMAND	
Description and Parameters	
get out N1 route↵	
Show the routing for the specified output.	
N1 = A ~ B	[Output port]
get in name list↵	
List all input names.	
get out name list↵	
List all output names.	
set out N1 auto mode N2↵	
Set the automatic switching behavior of the specified output.	
N1 = A ~ B	[Output port]
Available values for N2 :	
0	[Off]
1	[Auto switch]
2	[Auto scan]
get out N1 auto mode↵	
Show the currently selected automatic switching behavior of the specified output.	
N1 = A ~ B	[Output port]
get in N1 hactive↵	
Show the detected horizontal active pixel total for input N1's signal.	
N1 = 1 ~ 2	[Input port]
get in N1 vactive↵	
Show the detected vertical active pixel total for input N1's signal.	
N1 = 1 ~ 2	[Input port]
get in N1 refresh rate↵	
Show the detected refresh rate for input N1's signal.	
N1 = 1 ~ 2	[Input port]

COMMAND	
Description and Parameters	
get in N1 interlace↵	
Show if the source connected to input N1 is interlaced or not.	
N1 = 1 ~ 2	[Input port]
Possible response values:	
0	[Progressive]
1	[Interlaced]
get in N1 sync status↵	
Show the detected sync state for input N1.	
N1 = 1 ~ 2	[Input port]
Possible response values:	
0	[No sync]
1	[Sync active]
get in N1 timing↵	
Show the resolution and timing index value for input N1's signal.	
N1 = 1 ~ 2	[Input port]
get in N1 deep color↵	
Show the detected color bit depth for input N1's signal.	
N1 = 1 ~ 2	[Input port]
get in type list↵	
List the signal format of all inputs.	
get out type list↵	
List the signal format of all outputs.	
set out route N1N2,N1N2↵	
Set unique input routing for both outputs simultaneously.	
N1 = A ~ B	[Output port]
N2 = 1 ~ 2	[Input port]

COMMAND	
Description and Parameters	
set all out route N1↵	
Set input routing for all outputs.	
N1 = 1 ~ 2	[Input port]
get all out route↵	
List the current input routing for all outputs.	
set out N1 cec data N2↵	
Send a CEC command, as hex data, to the display connected to the specified output.	
N1 = A ~ B	[Output port]
N2 = {CEC data}	[Comma delimited hex pairs]
get out N1 cec capability↵	
Show if the display connected to the specified output supports CEC.	
N1 = A ~ B	[Output port]
set keylock N1↵	
Enable or disable the front panel key lock.	
Available values for N1 :	
ON	[Locked]
OFF	[Unlocked]
get keylock↵	
Show the current front panel key lock state.	
set current route to preset N1↵	
Save all current routing assignments to the specified preset.	
N1 = 1 ~ 2	[Preset number]
set route preset N1↵	
Activate the routing assignments saved in the specified preset.	
N1 = 1 ~ 2	[Preset number]

COMMAND	
Description and Parameters	
get preset N1 list ↵	
Show the current routing saved within preset N1.	
N1 = 1 ~ 2	[Preset number]
set route preset N1 name N2 ↵	
Set the name of preset N1.	
N1 = 1 ~ 2	[Preset number]
N2 = {Name}	[16 characters max]
get route preset N1 name ↵	
Show preset N1's current name.	
N1 = 1 ~ 2	[Preset number]
get in port number ↵	
Show the total number of input ports.	
get out port number ↵	
Show the total number of output ports.	
get out N1 sync status ↵	
Show the current link status of output N1.	
N1 = A ~ B	[Output port]
set analog output volume N1 ↵	
Set the analog output volume.	
N1 = -103 ~ +24	[Volume in dB]
get analog output volume ↵	
Show the current analog output volume.	
set analog output mute N1 ↵	
Enable or disable muting the analog audio output.	
Available values for N1 :	
ON	[Mute]
OFF	[Unmute]

COMMAND	
Description and Parameters	
get analog output mute↵	
Show the current mute state of the analog audio output.	
set in N1 edid N2↵	
Set the EDID to use on the specified input.	
N1 = 1 ~ 2	[Input port]
Available values for N2 :	
1	[FHD 2CH]
2	[FHD MCH]
3	[UHD 2CH]
4	[UHD MCH]
5	[UHD+ 2CH]
6	[UHD+ MCH]
7	[User 1]
8	[User 2]
9	[Sink A]
10	[Sink B]
get in N1 edid↵	
Show the EDID currently being used on the specified input.	
N1 = 1 ~ 2	[Input port]
get in edid list↵	
List all available EDID selections.	
set edid N1 name N2↵	
Set the name for the specified EDID. (Only User EDIDs may be renamed)	
N1 = 7 ~ 8	[User EDIDs]
N2 = {Name}	[16 characters max]

COMMAND	
Description and Parameters	
get edid N1 name↵	
Show the name for the specified EDID. (User EDIDs only)	
N1 = 7 ~ 8	[User EDIDs]
set user N1 edid data N2↵	
Upload a new EDID (in HEX format) for use as the specified User EDID.	
N1 = 7 ~ 8	[User EDIDs]
N2 = {EDID data}	[Comma delimited hex pairs]
get user N1 edid data↵	
Show the current contents of the specified User EDID as HEX data.	
N1 = 7 ~ 8	[User EDIDs]
get sink N1 edid data↵	
Show the EDID from the display connected to the specified output as HEX data.	
N1 = A ~ B	[Output port]
get in N1 edid data↵	
Show the EDID currently used by the specified input as HEX data.	
N1 = 1 ~ 2	[Input port]
get all in edid list↵	
List the EDIDs assigned to all inputs.	
get internal N1 edid data↵	
Show the specified Internal EDID as HEX data.	
N1 = 1 ~ 6	[Internal EDIDs]

COMMAND	
Description and Parameters	
set in N1 hdcp mode N2↵	
Set the HDCP behavior of the specified input.	
N1 = 1 ~ 2	[Input port]
Available values for N2 :	
0	[Support disabled]
1	[Follow source]
2	[Follow display]
get in N1 hdcp mode↵	
Show the current HDCP behavior used by the specified input.	
N1 = 1 ~ 2	[Input port]
get in N1 hdcp status↵	
Show the current HDCP status of the specified input.	
N1 = 1 ~ 2	[Input port]
Possible response values:	
0	[No HDCP]
1	[HDCP 1.x]
2	[HDCP 2.2]
get out N1 hdcp status↵	
Show the current HDCP status of the specified output.	
N1 = A ~ B	[Output port]
Possible response values:	
0	[No HDCP]
1	[HDCP 1.x active]
2	[HDCP 2.2 active]
3	[HDCP 1.x failed]
4	[HDCP 2.x2 failed]

COMMAND	
Description and Parameters	
get out N1 hdcp ability↵	
Show the HDCP compliance level of the display device connected to the specified output.	
N1 = A ~ B	[Output port]
Possible response values:	
0	[No HDCP]
1	[HDCP 1.x]
2	[HDCP 2.2]
3	[HDCP 1.x+2.2]
get in N1 hdcp ability↵	
Show the HDCP compliance level of the source connected to the specified input.	
N1 = 1 ~ 2	[Input port]
Possible response values:	
0	[No HDCP]
1	[HDCP 1.x]
2	[HDCP 2.2]
3	[HDCP 1.x+2.2]

Note: Commands will not be executed unless followed by a carriage return. Commands are not case-sensitive.

7. CONNECTION DIAGRAM

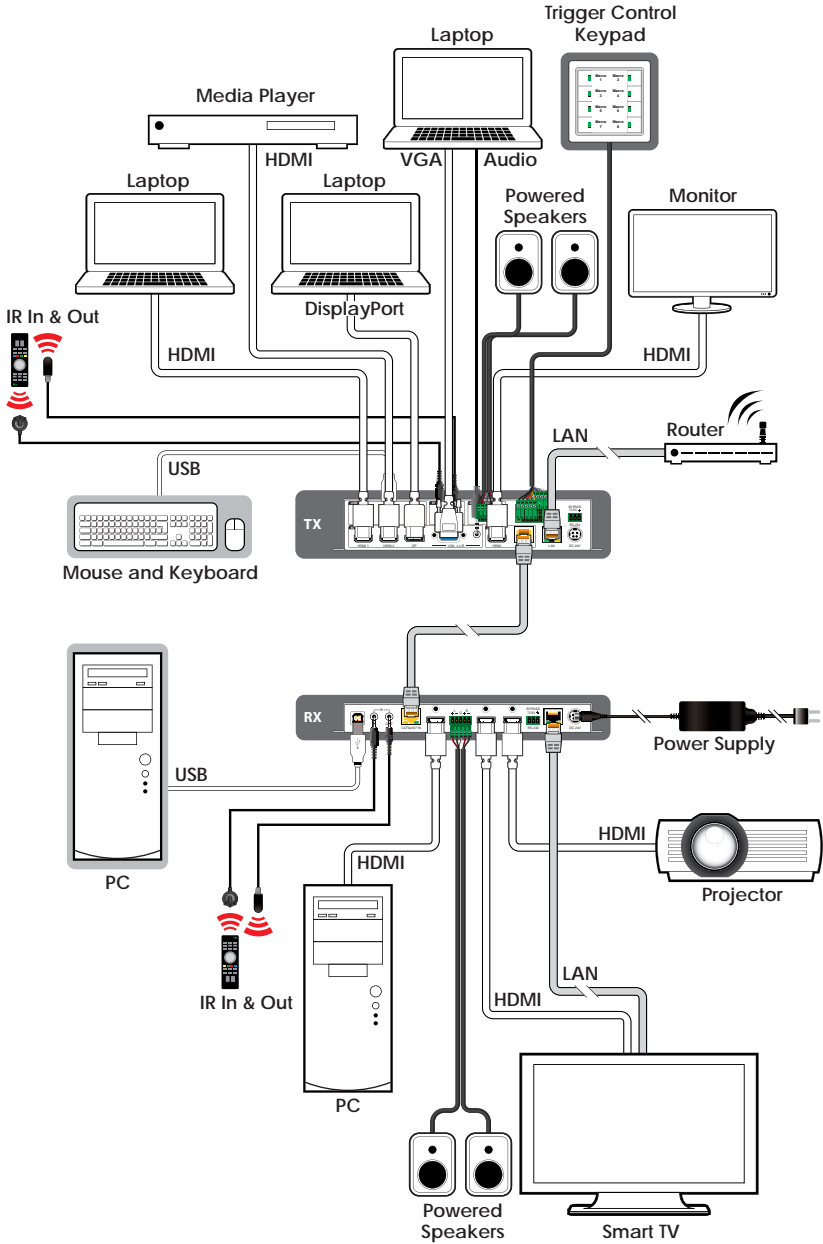

8. SPECIFICATIONS

8.1 Technical Specifications

HDMI Bandwidth	18Gbps
HDBaseT Bandwidth	10.2Gbps
Input Ports	1×HDMI (Type-A) 1×HDBaseT (RJ-45)
Output Ports	2×HDMI (Type-A) 1×Balanced Stereo (5-pin Term. Block)
Pass-through Ports	1×IR Extender (3.5mm) 1×IR Blaster (3.5mm) 2×USB 2.0 (Type A) 1×USB 2.0 (Type B) 1×RS-232 (3-pin Terminal Block)
Pass-through/Service Port	1×USB 2.0 (Type A)
Pass-through/Control Port	1×LAN (RJ-45)
Control Port	1×RS-232 (3.5mm)
IR Frequency	30 – 50kHz (30 – 60kHz under ideal conditions)
Baud Rate (Control)	19200 (Default)
Baud Rate (Bypass)	Up to 115200
Power Supply	24V/3.75A DC (US/EU standards, CE/FCC/UL certified)
ESD Protection (HBM)	±8kV (Air Discharge) ±4kV (Contact Discharge)
Dimensions (W×H×D)	231.5mm×44mm×160mm [Case Only] 231.5mm×44mm×167mm [All Inclusive]
Weight	928g
Chassis Material	Metal (Steel)



Chassis Color	Black
Operating Temperature	0°C – 40°C/32°F – 104°F
Storage Temperature	-20°C – 60°C/-4°F – 140°F
Relative Humidity	20 – 90% RH (Non-condensing)
Power Consumption	22.33W

8.2 Video Specifications

Supported Resolutions (Hz)	Input		Output
	HDMI	HDBaseT	HDMI
720×400p@70/85	✓	✓	✓
640×480p@60/72/75/85	✓	✓	✓
720×480i@60	✓	✓	✓
720×480p@60	✓	✓	✓
720×576i@50	✓	✓	✓
720×576p@50	✓	✓	✓
800×600p@56/60/72/75/85	✓	✓	✓
848×480p@60	x	x	x
1024×768p@60/70/75/85	✓	✓	✓
1152×864p@75	✓	✓	✓
1280×720p@50/60	✓	✓	✓
1280×768p@60/75/85	✓	✓	✓
1280×800p@60/75/85	✓	✓	✓
1280×960p@60/85	✓	✓	✓
1280×1024p@60/75/85	✓	✓	✓
1360×768p@60	✓	✓	✓
1366×768p@60	✓	✓	✓
1400×1050p@60	✓	✓	✓
1440×900p@60/75	✓	✓	✓
1600×900p@60RB	✓	✓	✓
1600×1200p@60	✓	✓	✓
1680×1050p@60	✓	✓	✓
1920×1080i@50/60	✓	✓	✓
1920×1080p@24/25/30	✓	✓	✓
1920×1080p@50/60	✓	✓	✓

Supported Resolutions (Hz)	Input		Output
	HDMI	HDBaseT	HDMI
1920×1200p@60RB	✓	✓	✓
2560×1440p@60RB	✓	✓	✓
2560×1600p@60RB	✓	✓	✓
2048×1080p@24/25/30	✓	✓	✓
2048×1080p@50/60	✓	✓	✓
3840×2160p@24/25/30	✓	✓	✓
3840×2160p@50/60 (4:2:0)	✓	✓	✓
3840×2160p@24, HDR10	✓	x	✓
3840×2160p@50/60 (4:2:0), HDR10	✓	x	✓
3840×2160p@50/60	✓	x	✓
4096×2160p@24/25/30	✓	✓	✓
4096×2160p@50/60 (4:2:0)	✓	✓	✓
4096×2160p@24, HDR10	✓	x	✓
4096×2160p@50/60 (4:2:0), HDR10	✓	x	✓
4096×2160p@50/60	✓	x	✓

8.3 Audio Specifications

8.3.1 Digital Audio

HDMI Input / Output	
LPCM	
Max Channels	8 Channels
Sampling Rate (kHz)	32, 44.1, 48, 88.2, 96, 176.4, 192
Bitstream	
Supported Formats	Standard & High-Definition

HDBaseT Input	
LPCM	
Max Channels	2 Channels
Sampling Rate (kHz)	32, 44.1, 48, 88.2, 96, 176.4, 192
Bitstream	
Supported Formats	Standard & High-Definition

8.3.2 Analog Audio

Analog Output	
Max Audio Level	1Vrms
THD+N	< -80dB@0dBFS 1kHz (A-wt)
SNR	> 80dB@0dBFS
Frequency Response	< ±1dB@20Hz~20kHz
Crosstalk	< -80dB@10kHz
Impedance	470Ω
Type	Balanced

8.4 Cable Specifications

Cable Length	1080p		4K30	4K60
	8-bit	12-bit	(4:4:4) 8-bit	(4:4:4) 8-bit
High Speed HDMI Cable				
HDMI Input	15m	10m	5m	3m
HDMI Output	15m	10m	5m	3m
Ethernet Cable				
Cat.5e/6	100m		90m	
Cat.6a/7	100m		100m	

Bandwidth Category Examples:

- **1080p (FHD Video)**
 - Up to 1080p@60Hz, 12-bit color
 - Data rates lower than 5.3Gbps or below 225MHz TMDS clock
- **4K30 (UHD Video)**
 - 4K@24/25/30Hz & 4K@50/60Hz (4:2:0), 8-bit color
 - Data rates higher than 5.3Gbps or above 225MHz TMDS clock but below 10.2Gbps
- **4K60 (UHD+ Video)**
 - 4K@50/60Hz (4:4:4, 8-bit)
 - 4K@50/60Hz (4:2:0, 10-bit HDR)
 - Data rates higher than 10.2Gbps

8.5 HDBaseT Features

HDBaseT Feature Set	Receiver
Video & Audio	Supported
LAN Pass-through	Supported
Send power to Transmitter	Supported
Accept power from Transmitter	Unsupported
IR Pass-through	Supported
RS-232 Pass-through	Supported

9. ACRONYMS

ACRONYM	COMPLETE TERM
ADC	Analog-to-Digital Converter
ASCII	American Standard Code for Information Interchange
AV	Audio/Video
Cat.5e	Enhanced Category 5 cable
Cat.6	Category 6 cable
Cat.6a	Augmented Category 6 cable
Cat.7	Category 7 cable
CLI	Command-Line Interface
DAC	Digital-to-Analog Converter
DHCP	Dynamic Host Configuration Protocol
DP	DisplayPort
DVI	Digital Visual Interface
EDID	Extended Display Identification Data
GUI	Graphical User Interface
HD	High-Definition
HDBT	HDBaseT
HDCP	High-bandwidth Digital Content Protection
HDMI	High-Definition Multimedia Interface
HDR	High Dynamic Range
HDTV	High-Definition Television
IP	Internet Protocol
IR	Infrared
KVM	Keyboard/Video/Mouse
LAN	Local Area Network
LED	Light-Emitting Diode
LPCM	Linear Pulse-Code Modulation
MAC	Media Access Control

ACRONYM	COMPLETE TERM
PD	Powered Device
PoH	Power over HDBaseT
PSE	Power Sourcing Equipment
SNR	Signal-to-Noise Ratio
TCP	Transmission Control Protocol
THD+N	Total Harmonic Distortion plus Noise
UHD	Ultra-High-Definition
UHD+	Ultra-High-Definition Plus
UHDTV	Ultra-High-Definition Television
USB	Universal Serial Bus
VGA	Video Graphics Array
WUXGA (RB)	Widescreen Ultra Extended Graphics Array (Reduced Blanking)
XGA	Extended Graphics Array



CYPRESS TECHNOLOGY CO., LTD.

www.cypress.com.tw