

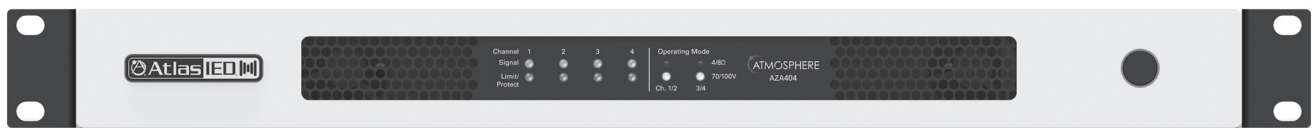

AZA404 / AZA804 Digital Power Amplifiers



AZA Series

Owner's Manual

Table of Contents

Important Safety Instructions.....	3
Introduction	5
Key Features.....	5
AZA Amplifier Configuration.....	6
Front Panel Description	8
Rear Panel Description	9
Changing From 115V - 120V to 220V-240V Operation	9
Rack Ear Installation	10
Locating the AZA On a LAN.....	11
I. Direct Connection via Ethernet.....	11
II. Web Browser via Network Router.....	12
III. AtlasIED AZA IP Discovery Software.....	12
Logging into the Amplifier	13
Change Login Username and Password	13
AZA UI Overview	13
Output Channel Indicators.....	14
Output Channels Level Meters.....	14
Output Channel Limiter & Clip / Fault Indicators	14
Output Channel Mute.....	14
Amplifier Load Settings.....	15
Auto Power Down Settings.....	15
Front Panel Power Switch Settings.....	15
AZA Factory Default Settings	15
Identifying the Firmware Version.....	16
Static IP	16
Resetting the Amp to DHCP Mode.....	17
Resetting the Login Username & Password	17
Accessory Card Installation	17
Installation and Considerations	18
Specifications	19
Warranty.....	24

AZA Series

Owner's Manual

Important Safety Instructions

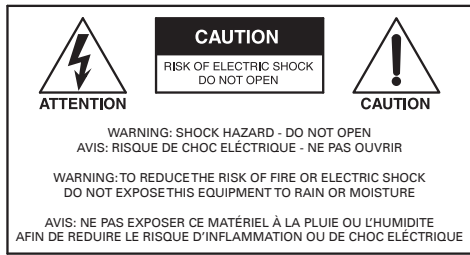

The lightning flash with arrowhead symbol within an equilateral triangle, is intended to alert the user to the presence of uninsulated "dangerous voltage" within the product's enclosure that may be of sufficient magnitude to constitute a risk of electric shock to persons.



The exclamation point within an equilateral triangle is intended to alert the user to the presence of important operating and maintenance (servicing) instructions in the literature accompanying the product.

1. Read these instructions.
2. Keep these instructions.
3. Heed all warnings.
4. Follow all instructions.
5. Do not use this device near water.
6. Clean only with dry cloth.
7. Do not block any ventilation openings. Install in accordance with the manufacturer's instructions.
8. Do not install near any heat sources such as radiators, heat registers, stoves, or other device that produce heat.
9. Do not defeat the safety purpose of the polarized or grounding-type plug. A polarized plug has two blades with one wider than the other. A grounding type plug has two blades and a third grounding prong. The wide blade or the third prong are provided for your safety. If the provided plug does not fit into your outlet, consult an electrician for replacement of the obsolete outlet.
10. Protect the power cord from being walked on or pinched particularly at plugs, convenience receptacles, and the point where they exit from the device.
11. Only use attachments / accessories specified by the manufacturer.
12. Use only with the cart, stand, tripod, bracket, or table specified by the manufacturer, or sold with the device. When a cart is used, use caution when moving the cart / device combination to avoid injury from tip-over.



13. Unplug this device during lightning storms or when unused for long periods of time.
14. Refer all servicing to qualified service personnel. Servicing is required when the device has been damaged in any way, such as power-supply cord or plug is damaged, liquid has been spilled, or objects have fallen into the device, the device has been exposed to rain or moisture, does not operate normally, or has been dropped.
15. This product is equipped with a three-wire grounding-type plug, a plug having a third (grounding) pin. This plug will only fit into a grounding-type power outlet. This is a safety feature. If you are unable to insert the plug into the outlet, contact your electrician to replace your obsolete outlet. Do not defeat the safety purpose of the grounding-type plug.
16. **WARNING:** To reduce the risk of fire or electric shock, this device should not be exposed to dripping, splashing, rain, or moisture, and objects filled with liquids, such as a vase, should not be placed on this device.
17. To completely disconnect this equipment from the mains, disconnect the power supply cord plug from the receptacle.
18. The mains plug of the power supply cord shall remain readily operable.
19. Protective earthing terminal. The apparatus should be connected to a mains socket with a protective earthing connection.

AZA Series

Owner's Manual



WARNING - When The Device Is In Use

- WARNING: For the terminals marked with symbol of ⚡ may be of sufficient magnitude to constitute a risk of electric shock. The external wiring connected to the terminals requires installation by an instructed person or the used of ready-made leads or cords.
- WARNING: The apparatus shall not be exposed to dripping or splashing and that objects filled with liquids, such as vases, shall not be placed on apparatus.
- WARNING: The mains plug is used as disconnect device, the disconnect device shall remain readily operable.
- To prevent electric shock, do not remove the product cover as there are high voltage components inside. Refer all servicing to AtlasIED.
- Should any of the following irregularities occur during use, immediately switch off the power, disconnect the power cord from the AC outlet and contact AtlasIED. Do not to attempt to continue operation with the product as this may cause fire or electric shock:
 - Smoke or strange smell coming from the unit.
 - If the product falls or the case is damaged.
 - If water or any metallic objects falls into the product.
 - If the power supply cord is damaged in any way.
 - If the unit is malfunctioning.
- Do not insert or drop metallic objects or flammable materials into the ventilation holes of the product's cover, as this may result in electric shock or fire.
- Do not place any containers with liquid or metallic objects on the top of the product. If any liquid spills into the unit, fire or electric shock may result.
- Never operate this product or touch the power supply cord during an electrical storm, electric shock may result.
- Never exceed the power rating on the product when connecting equipment. Fire and/or property damage may result.
- Operate the product only with the voltage specified on the unit. Fire and/or electric shock may result if a higher voltage is used.
- Do not modify, kink, or cut the power cord. Do not place the power cord in close proximity to heaters and do not place heavy objects on the power cord, including the product itself, doing so may result in fire or electrical shock.
- Ensure that the safety ground terminal is connected to a proper ground. Never connect the ground to a gas pipe as a catastrophic disaster may result.
- Be sure the installation of the product is stable, avoid slanted surfaces as the product may fall and cause injury or property damage.



CAUTION - When Installing The Product

- Plugging in or unplugging the power cord with wet hands may result in electric shock.
- Never move the unit with the power cord plugged into the wall, as damage to the power cord may result.
- When unplugging the cord from the wall, grasp the plug, NOT the cord.
- Never install this product in humid or dusty locations, nor in direct sunlight, near sources of heat, or in areas where sooty smoke or steam are present. Fire and electric shock may result.
- Keep all sides of the unit at least 3 1/2" away from objects that may obstruct air flow to prevent the unit's internal temperature rise.



CAUTION - When The Product Is In Use

- Never place heavy objects on the product, causing it to fall and/or break, resulting in personal injury and property damage. In addition, the product itself may fall and cause injury and property damage.
- Contact AtlasIED for instructions on cleaning the inside of the unit. Large accumulations of dust inside the unit may result in heat buildup and fire.
- Ensure that the power supply plug is securely plugged into the wall outlet. Never allow dust to accumulate on the power plug or inside the wall outlet.
- When cleaning the unit or the unit is not to be operated for an extended period, unplug the power cord from the wall.

AZA Series

Owner's Manual

Introduction

The AtlasIED Atmosphere AZA404 and AZA804 are four-channel amplifiers that are designed to interface with the Atmosphere family of products, such as the AZM series of processors. The AZA amplifiers can be configured in three different configurations to meet the design requirements of any installation. These AZA models are factory preconfigured in a four-channel, 70V mode. If the design requires four channels of low impedance amplification, the AZA amplifiers can be configured as four-channel models with either 4Ω or 8Ω load impedances. Many system designs require both low and high impedance amplification. These AZA models can be configured to deliver 70V / 100V for a paging/background system on two (2) channels plus two (2) additional 4Ω or 8Ω amplifier channels for foreground stereo application.

These AZA models come standard with four (4) balanced line inputs and an accessory slot for an optional four-channel Dante™ receiver card (model DPA-DAC4), giving the AZA404 and AZA804 a total of up to eight (8) inputs. All inputs can be mixed and routed to any of the four amplifier channels. All four (4) amplifier channels have an assortment of advanced DSP tools.

AZA Series amplifiers feature either network control. The AZA series amplifiers include a windows-based AZA Amplifier IP Discovery Tool that automatically searches within a specific network for all available AZA amplifiers.

The AZA404 and AZA804 are ready to use, out of the box in four-channel, 70V mode, with no configuration or network connectivity required, making them ideal for use with AtlasIED Atmosphere Zone Controllers.

Key Features

- AZA404 Configuration Power Levels
 - 4 x 100-Watt 70V (Factory Default)
 - 4 x 100-Watt 100V
 - 4 x 75-Watt @ 8Ω
 - 4 x 50-Watt @ 4Ω
 - 2 x 100-Watt 70V/100V & 2 x 75-Watt @ 8Ω
 - 2 x 100-Watt 70V/100V & 2 x 50-Watt @ 4Ω
- AZA804 Configuration Power Levels
 - 4 x 200-Watt 70V (Factory Default)
 - 4 x 200-Watt 100V
 - 4 x 150-Watt @ 8Ω
 - 4 x 100-Watt @ 4Ω
 - 2 x 200-Watt 70V/100V & 2 x 150-Watt @ 8Ω
 - 2 x 200-Watt 70V/100V & 2 x 100-Watt @ 4Ω
- 4 Amplified Channels
- Integrates with Atmosphere AZM Zone Master
- Energy Efficient
- Convection Cool / Fan Assist
- Accepts Low Z & Hi Z Loads
- Onboard Web UI for Remote Monitoring of Status & Levels
- Front Panel Power Switch Disable
- APD - Auto Power Down with Audio Sense Turn On
- Dante™ Optional Accessory Card Slot

AZA Series

Owner's Manual

Applications

AZA Series amplifiers integrate with Atmosphere signal processors which makes them ideal for use in restaurants, presentation rooms, classrooms, conference rooms, and retail background/foreground music applications.

AZA Amplifier Configurations

Note: For illustration purposes, model AZA404 is used for all examples. The AZA804 will be wired and configured identically to the AZA404. All AZA models have the same features and panel layout. The difference between models is the output power level.

Configuration #1 4 Channel 70V / 100V (Factory Default)

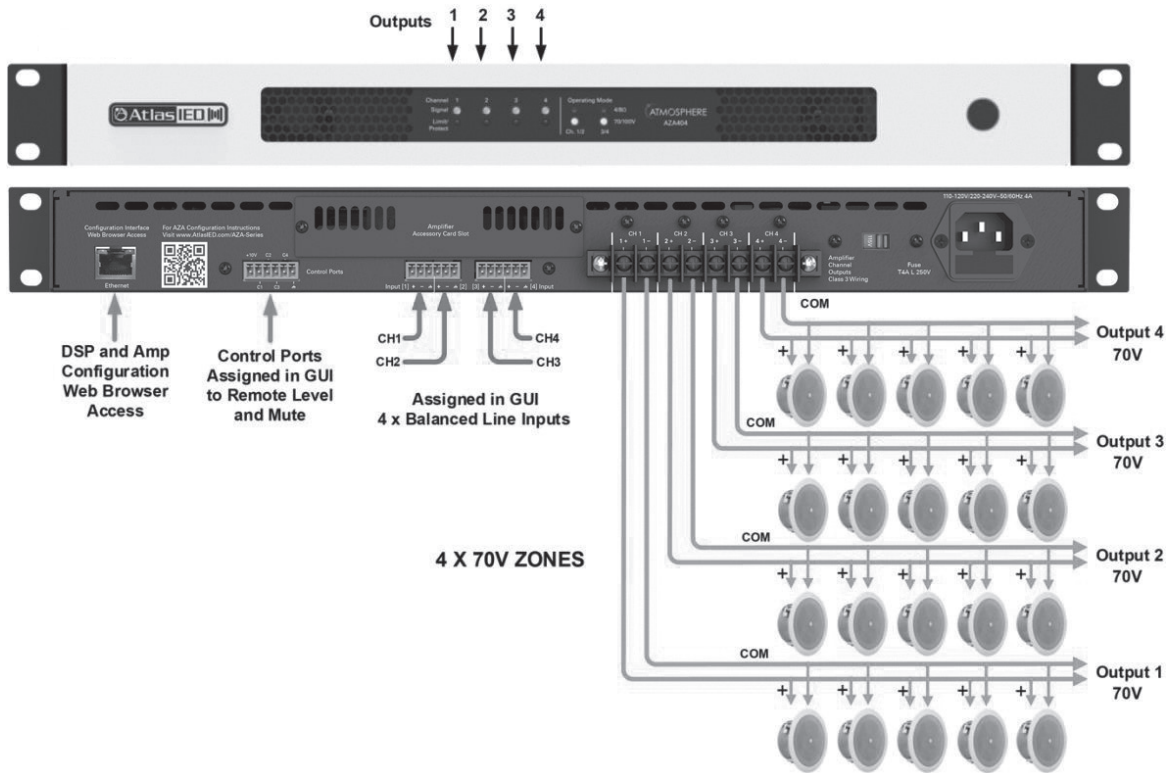

AZA Series

Owner's Manual

AZA Amplifier Configurations

Configuration #2 4 Channel 4Ω / 8Ω

(Output Impedance Assigned in GUI in Pairs)

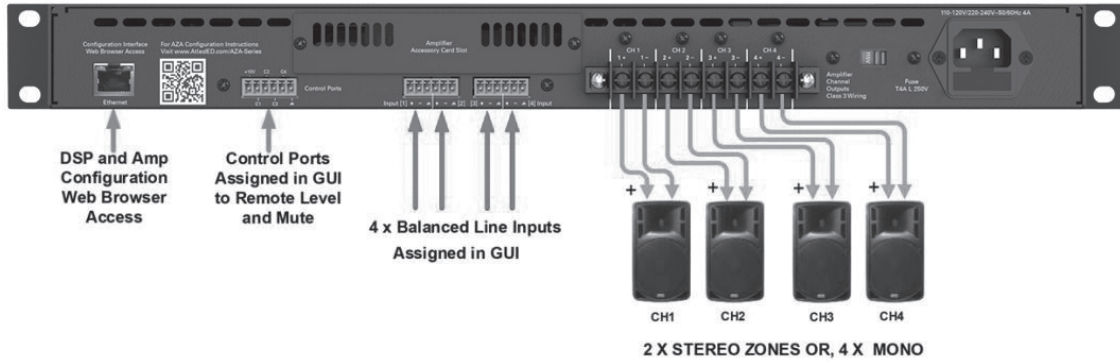

Configuration #3 2 Channel 70V / 100V & 2 Channel 4Ω / 8Ω

(Assigned in GUI in Pairs)

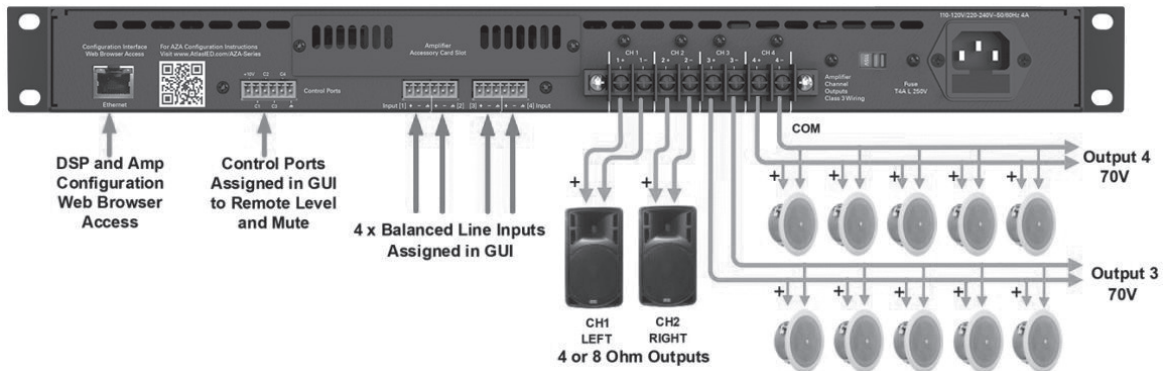

AZA Series

Owner's Manual

Front Panel

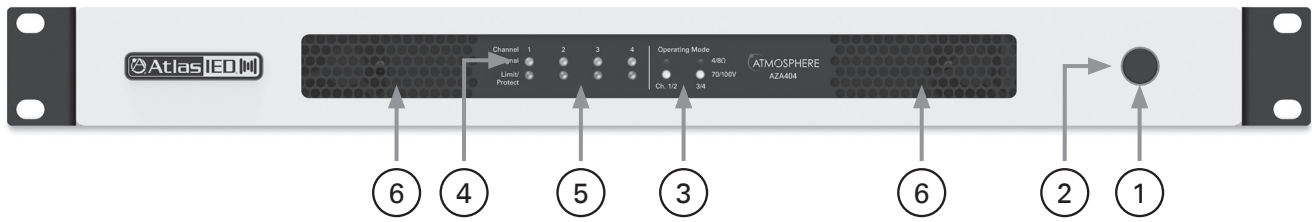

1. Power Switch

This toggles the amplifier between Active Mode or Sleep Mode.

2. LED Power Indicator

The AZA amplifier has three states of idle power that are indicated as follows:

- Active Mode - When the LED outer ring of the power switch illuminates a steady blue color, the amplifier is in Active Mode and is ready to pass audio. This is AZA factory default shipping mode.
- Sleep Mode - When the LED outer ring is Off, the unit is in Sleep Mode. In Sleep Mode, the Ethernet is active for access to the amplifiers on board UI while the amplifier output stage and DSP are Off. Audio will not pass in Sleep Mode.
- Standby APD Mode - When the amplifier Auto Power Down (APD) feature is enabled and the amplifier is in APD mode, the LED outer ring will blink blue once every 5 seconds.

3. Operating Mode Indicators

Each AZA amplifier can be configured three ways. The LEDs in this area indicate the configuration of the amplifier. These indicators illuminate if Channels 1 / 2 and 3 / 4 are operated separately in 4Ω / 8Ω mode or 70V / 100V mode. Amplifier operation mode setting is completed using the internal DSP UI.

- 4-Channel high impedance 70V / 100V mode
- 4-Channel low impedance 4Ω or 8Ω mode
- 2-Channel high impedance 70V / 100V mode & 2-Channel low impedance 4Ω / 8Ω mode

4. Channel 1, 2, 3, 4 Signal LED

The Signal LED will illuminate green if audio signal is present at that channel's output.

5. Channel 1, 2, 3, 4 Limit/Protect/Mute LED

The Limit/ Protect LEDs will illuminate red if one of the following conditions occurs:

- Any channel of the AZA amplifier reaches maximum output power. The AZA features an adjustable amplifier OUTPUT limiter which helps prevent the amplifier from hard clipping. An occasional flash of the LED is OK but if the LED illuminates continuously reduce the amplifier's input level. If the Clip LED remains On after reducing the input level, recheck the load connected to the amplifier.
- The OUTPUT has been muted in the UI.
- A fault is detected within the amplifier. Once the fault is corrected, it may be required to reset the AC Mains power to reset the amplifier protect mode.

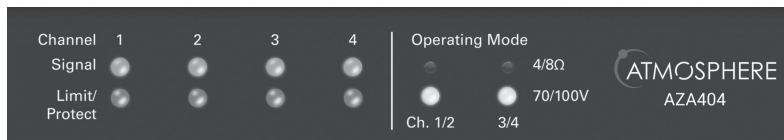

6. Air Exhaust

Each model includes convection cooling with dynamic fan assist for extreme conditions. If the unit is not being used or is in Standby mode, the fan is not needed for cooling and remains Off until the unit is in heavy use. As heat is generated in the amplifier during use, the fan activates at a low speed and increases as needed to keep the amplifier at safe operating temperature. This cooling method eliminates the need for air filters that can become clogged and require maintenance. The AZA amplifier's air flow is from rear to front.

AZA Series

Owner's Manual

Rear Panel

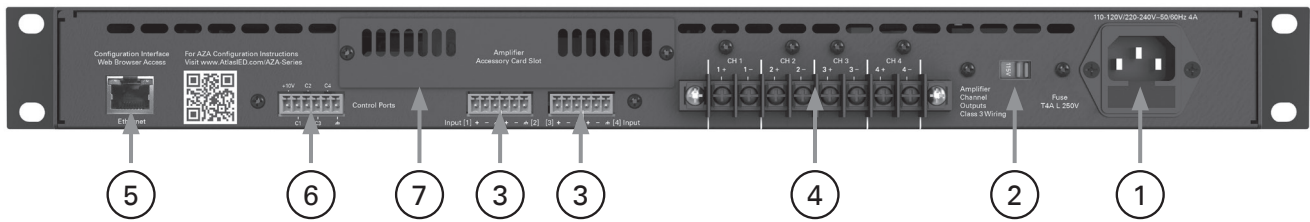

1. IEC AC Receptacle

The AZA amplifier can operate between 110VAC - 120VAC (115V AC Mains Line Voltage Selection) or between 220VAC - 240VAC (230V AC Mains Line Voltage Selection). The included IEC cord is designed to work with 110VAC - 120VAC. A compatible IEC cord will need to be purchased for 220VAC - 240VAC operation. The IEC receptacle houses the AC mains fuse. **Note:** Changing the fuse must be completed by a qualified technician.

- AZA404 Fuse: T4AL 250V, Slow Blow, 5mm x 20mm, Glass
- AZA804 Fuse: T8AL 250V, Slow Blow, 5mm x 20mm, Glass

2. AC Mains Line Voltage Select Switch – Important!

The AZA amplifier comes configured to the 115V setting. This setting can be used with AC Mains between 110VAC - 125VAC. If 220VAC - 240VAC operation is required, the Line Voltage Select Switch needs to be changed to the 230V position. After changing the switch position, reinstall the switch lock cover. **Note:** If the AC Mains Select Switch is not set to the proper line voltage setting, the amplifier will be damaged and will not be covered under warranty.

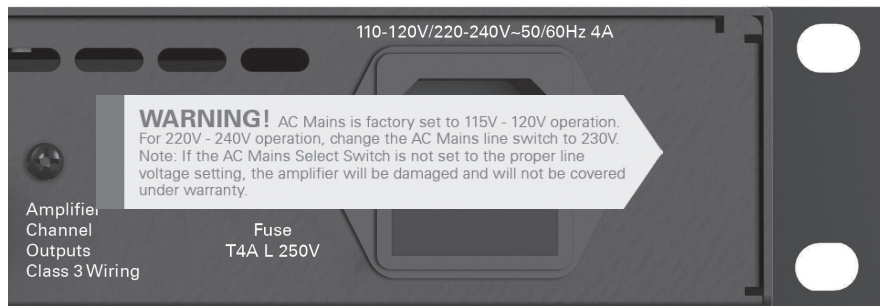

3. Input Connections

Inputs 1 - 4 accept balanced input signals via the removable 3.5mm Phoenix type connector. For wiring, follow the labeling on the rear of the amp. For unbalanced signals, connect the (-) and (GND) pins together.

AZA Series

Owner's Manual

Rear Panel

4. Speaker Connection

A screw terminal block connector is supplied to connect speakers to the AZA amplifier. It is recommended to use Class 3 rated, 14-gauge wire or lower for speaker wiring. Amplifier output channel configurations are in the amplifier web UI. The AZA is shipped with two speaker output terminal covers. AtlasIED recommends placing the security covers on the amplifier after wiring and before turning the amplifier on for configuration. Included in the carton are eight (8) Yellow Spade Lug 0.250 OD spade crimp terminals that accept up to 12-gauge wire and four (4) security cover screws (M3 x 8mm). Terminal block screws are M4.

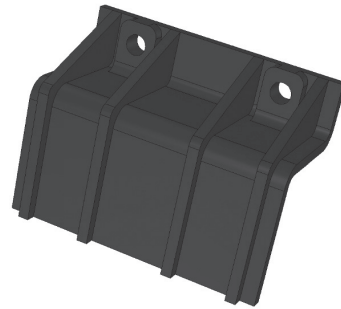
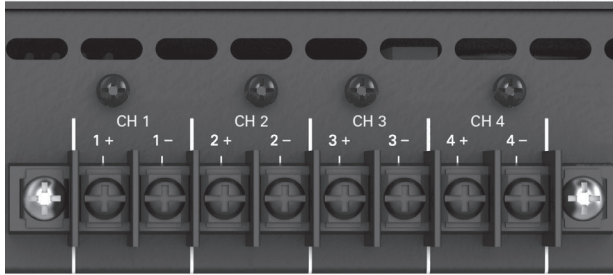

Note: The AZA amp is preconfigured at the factory for four-channel 70V/100V mode. Follow the manual wiring information to connect the distributed audio system.

5. Ethernet Port

Connect the amplifier to a network, local computer, or router / switch using CAT5 (or greater) cable to access the amplifier's DSP and control settings.

6. Control Ports

The AZA Series allows you to assign / configure the four control ports located on the rear of the amplifier to perform Remote Level or Mute functions.

Note: Each Control Port pin can only be assigned to one function such as Mute or Level, but not both. Control Port assignment is done in the AZA UI Advance Setting section. **Note:** If you are using the amplifier with an Atmosphere Zone Master, these features are not needed. Refer to the AZA404 & AZA804 Advance Settings Manual located at <https://www.atlasied.com/Atmosphere/AZA/>

7. Accessory Card Slot

An additional four (4) inputs can be routed to any of the four (4) output channels using an optional accessory card, AtlasIED model DPA-DAC4, which includes four (4) channels of Dante™ digital audio. Contact AtlasIED for a list of additional accessory cards. See section "Accessory Card Installation" on page 17 for information on installation or damage may occur. **Note:** Accessory card installation must be done by a qualified technician. **Note:** In standby mode there are DC voltages present at the accessory card port. The AZA amplifier must be removed from the AC Mains source in order to prevent damage to the card or amplifier. Accessory card initialization is done through the Advance Settings Button in the AZA UI. **Note:** If you are using the amplifier with an Atmosphere Zone Master, these features are not needed. Refer to the AZA404 & AZA804 Advance Settings Manual located at <https://www.atlasied.com/Atmosphere/AZA/>

Rack Ear Installation

The AZA amplifiers come with removable rack ears for mounting the amplifier into a 19" equipment rack. Included are two (2) universal Left and Right rack ears. Each rack ear requires four (4) M4 x 8MM Pan Head Phillips screws. Nine (9) of these screws are included in the box.

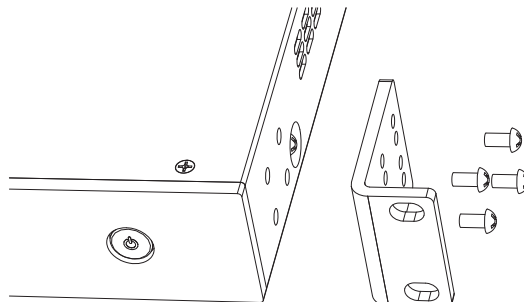

AZA Series

Owner's Manual

Finding an AZA Amplifier On a LAN

AZA amplifiers include a unique set of features and configurations. All AZA amplifiers are configured from the factory out of the box to operate as traditional commercial power amplifiers. Ethernet connectivity is not required for operation. When used with Atmosphere signal processors only the Output Mode may need to be changed (default is 70V). The AZA web UI must be accessed via a network or local computer to make AZA amplifier settings adjustments. External software is not required to operate the AZA amplifier; the software is embedded in the amplifier in what is called the "web browser UI Control Panel interface." Follow one of the three methods listed below to access the onboard control panel.

Accessing the GUI Control Panel

- I. Direct Connection via Ethernet
- II. Web Browser via Network Router
- III. AtlasIED AZA Amplifier Discovery Tool

I. Direct Connection via Ethernet

Use this method if there is no network access available.

1. Connect an Ethernet cable from a laptop or desktop computer to the ethernet input on the AZA amplifier. Most computers will allow direct connection from the AZA amplifier using a standard CAT5 cable.
2. Turn OFF the computer's Wi-Fi.
3. Open a web browser, AtlasIED suggests using Google Chrome.
4. In the web browser address bar, type in the following: `http://AZA804` and hit enter. For this example, we are connecting to the AZA model AZA804. An example is shown below.

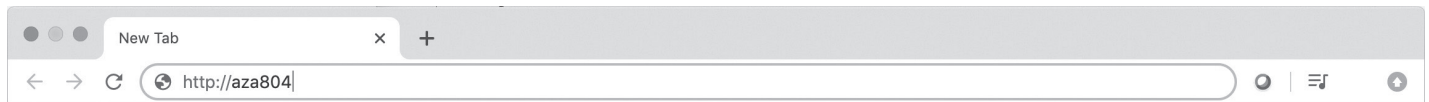

5. Out of the box the amplifier's model number is all that is needed to connect. It is not case sensitive, but the full exact name is required.

Note: During configuration, the amplifier's name can be changed. As an example, at a school the amplifier may be renamed "ROOM1". After the name is changed, follow the same process to log into the amplifier as outlined above, but change the name from "http://aza804" to "http://room1". Alternatively, the AZA amplifier's IP address can be directly entered into the web browser to access the AZA UI. **Example:** "http://192.168.1.110".
6. The AZA UI Page will launch after pressing the "Enter" key. An example of the AZA UI page is shown below. **Note:** It is required to enter a Username and Password to access the UI home page. Factory default for username is "admin" and the password is "admin". **Note:** When logging into the AZA amplifier for the first time and after entering the Factory Default username and password you will be prompted to change the password.

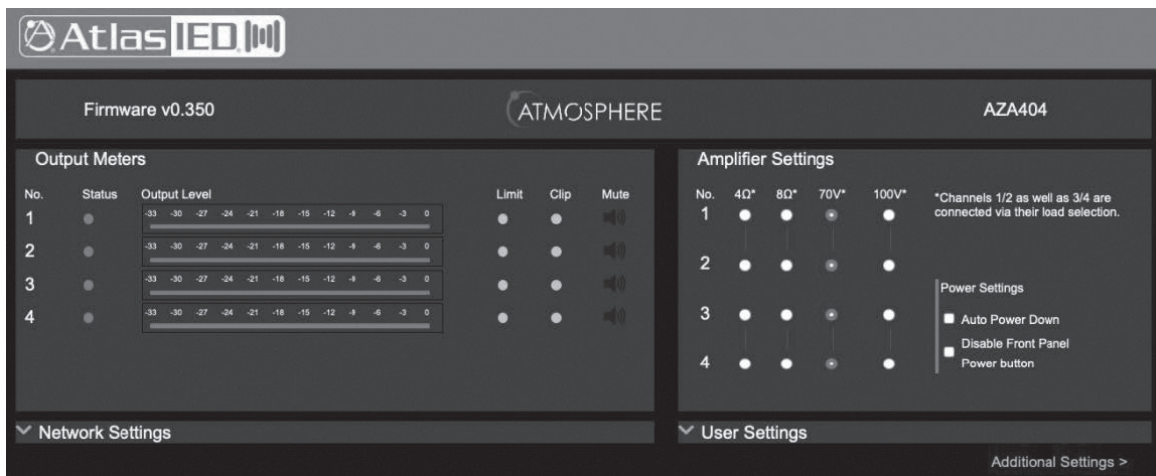

AZA Series

Owner's Manual

Finding an AZA Amplifier On a LAN

II. Web Browser via Network Router

This method is very similar to the Direct Connection method covered in Section 1 but uses a web browser on the local network to discover the AZA amplifier.

1. Connect the AZA Amplifier using a standard Ethernet cable to a router. Make sure the router is in DHCP mode.
2. Connect a computer to the same router via an Ethernet cable or Wi-Fi.
3. Open a web browser, AtlasIED suggests using Google Chrome or Mozilla Firefox.
4. In the web browser address bar, type in the following: `http://AZA804` and hit enter. For this example, we are connecting to the AZA model AZA804. An example is shown below.

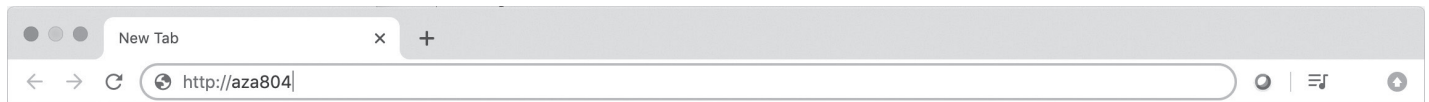

5. Out of the box the amplifier's model number is all that is needed to connect. It is not case sensitive, but the full exact name is required.
 - Note:** Once connected, the name of the amplifier can be changed to meet the install's naming scheme.
6. The amplifier will be discovered and the AZA UI will launch after pressing the "Enter" key. An example of the AZA UI web page is shown below. Alternatively, the AZA amplifier's IP address can be directly entered into the web browser to access the AZA UI. Example: "`http://192.168.1.110`".

III. AtlasIED AZA Discovery Tool

Using this IP discovery tool is the easiest way to find and connect to any AZA amplifiers on the LAN. Visit the AtlasIED web site to download the AZA Amplifier Discovery Tool at <https://www.atlasied.com/Atmosphere/AZA/>. The image below is an illustration of the discovery tool features. Click on "Discover Amplifiers" and any AZA amps that are on the LAN will populate in a list. Select the unit to access and the IP link will take the user to the unit's UI login page as shown above. **Note:** This software will only work on a PC.



AZA Amplifier Discovery Software Desktop Icon

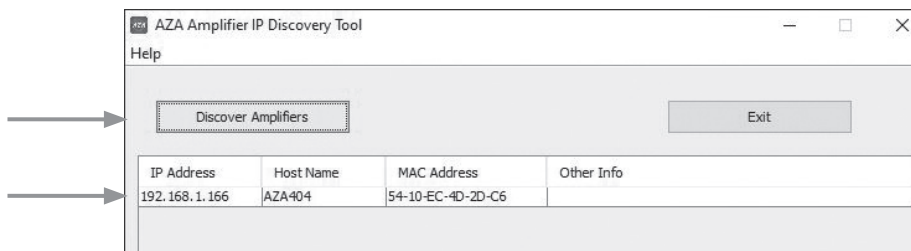

AZA Amplifier Discovery Software

AZA Amplifier Discovery Software

This software only operates on the PC. Select the Discover Amplifier button. A list of AZA and DPA amplifiers located on the network will be shown. Click on the IP address of the amplifier you want to connect to. You then will be taken to the web page requesting you to enter the factory default Username (admin) and Password (admin).

AZA Series

Owner's Manual

Logging into The Amplifier The First Time

Once you have entered in the web browser via one of the methods listed above, you will be prompted to enter the factory default Username (admin) and Password (admin). After entering the factory default Username and Password the AZA amplifier UI will open with a pop up window stating "Default Password detected. You must change the password!". Select close and go to the User Settings section to change the password.

Log in to 192.168.1.166:80
Your password will be sent unencrypted.

admin

Remember this password

Cancel Log In

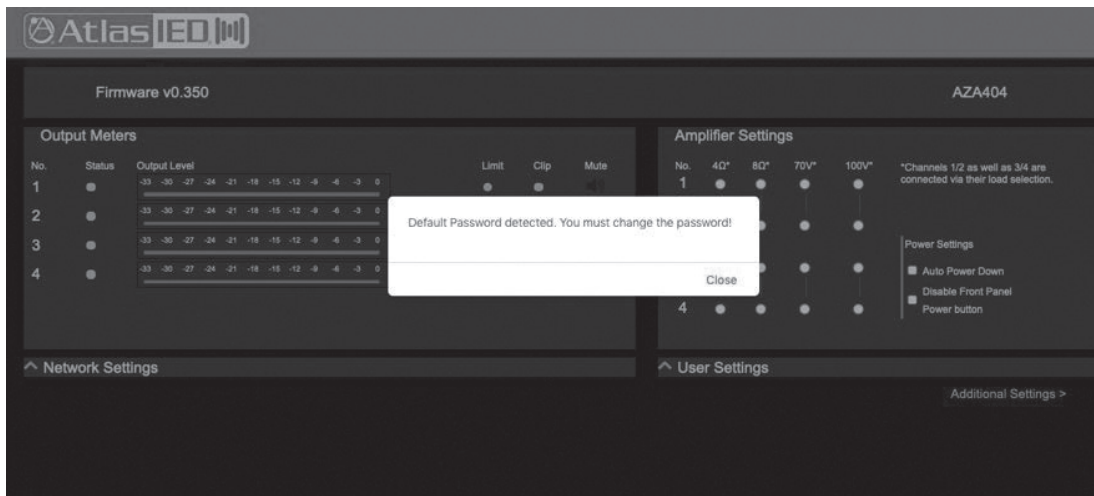

Changing Login Username & Password For The First Time

After entering the factory default username and password the user will be prompted to change the unit's password before continuing. At that time, it is also recommended to update the username. Within the User Settings section, there is a drop down arrow to choose between Username and Password. When finished select "SAVE" so the setting changes will take effect.

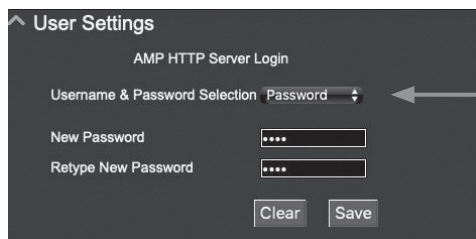

Change Password

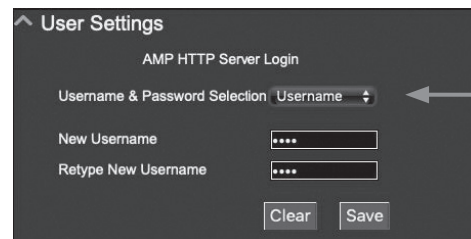

Change Username

Resetting the Password

If the Username or Password are forgotten, a password reset will be needed. This will reset both the Username and Password back to factory default of "admin". DHCP will also be enabled. The DSP settings will not be changed. Refer to the section "Resetting the Login Password & Username"

AZA Series

Owner's Manual

AZA UI Overview

When the AZA UI is accessed for the first time, the user will see the following settings in image below. These AZA settings are preset to mate with the Atmosphere Zone Master. Audio levels and EQ settings are handled in the Atmosphere Zone Master.

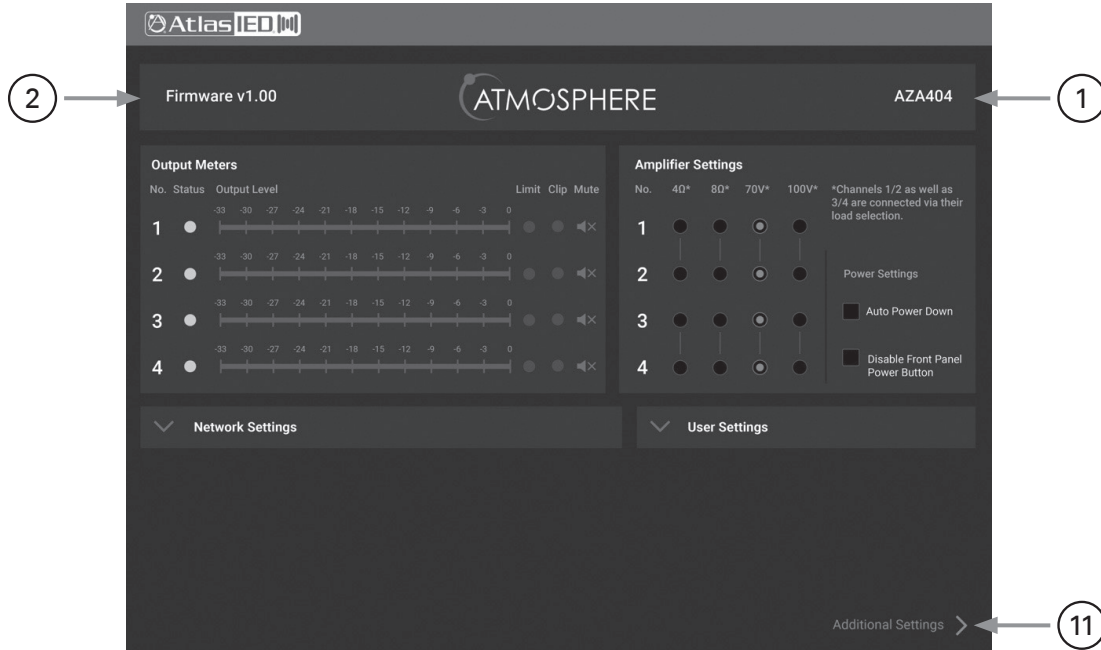

1. Model Name

Shows the model name of the AZA amplifier

2. Firmware Revision

Shows the firmware version the AZA is operating with. Refer to the section "Firmware Updates" for details on how to verify if the AZA amplifier has the latest firmware version.

3. Output Channel Status Indicator

- Blue indicator means ready and active.
- Red indicator means the channel is muted.

4. Output Channel Level Meter

5. Output Channel Limit Indicator

Illuminates yellow when the limiter is engaged.

6. Output Channel Clip / Fault Indicator

- Clip illuminates red when the amplifier output has reached its maximum output power.
- Fault illuminates red when the channel has a fault condition such as an improper load applied for the configuration setting, short on the output, or failed output channel. **Note:** It may be necessary to reset the AC Mains Power to clear the amplifier from protect mode.

7. Output Channel Mute Button

Illuminates red when in mute mode. Click on it to release the mute. **Note:** When an output channel is muted, the associated front panel Limit / Clip LED will flash.

AZA Series

Owner's Manual

AZA UI Overview

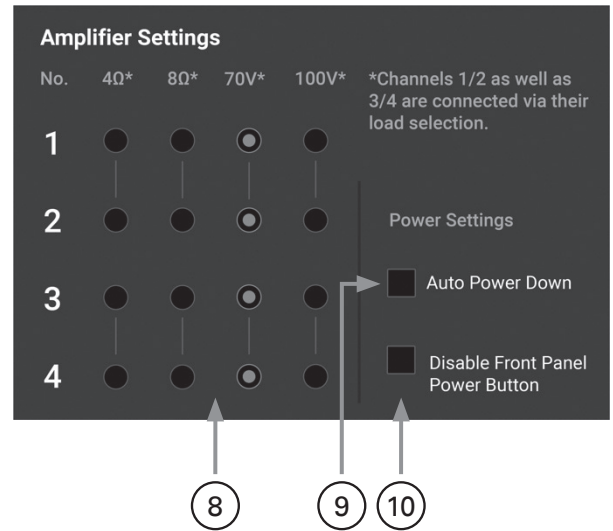

8. Amplifier Output Load Configurations

Configure the amplifier outputs to be either 70V / 100V or 4Ω / 8Ω. Amplifier output selections are in pairs. **Note:** Factory default CH1, CH2, CH 3, CH 4 are set to 70V.

9. Auto Power Down (APD) Button

Auto Power Down (APD) Enable / Disable. When this box is checked the unit is in Auto Power Down (APD) mode. After 30 minutes with no audio signal at the amplifier, the AZA amplifier will enter Standby APD Mode. In Standby APD Mode the amplifier will draw less power. The AZA amplifier has three states of idle power consumption to meet installation energy power consumption requirements. Refer to the amplifier specifications page in this manual for power consumption data. Refer to the section on "Understanding the 3 AC Power Consumption Idle States" for a definition on how each idle state operates. When the amplifier senses signal on any of the inputs, the amplifier will automatically switch from APD Mode to Active Mode. **Note:** APD is not enabled by default.

10. Front Panel Power Switch Disable Button

When selecting this box, the front panel power switch is disabled. The amplifier can only be turned On / Off through the web UI or by removing the power cord. **Note:** The front panel power button is enabled by default.

11. Advance Settings Button

This button will take you to the advanced section of the UI. This section allows you access to I/O Routing, Output EQ, Delay, Output Level, Output Limiters, Control Port Assignment and accessory card initialization. **Note:** If you are using the amplifier with an Atmosphere Zone Master, these features are not needed. Refer to the AZA404 & AZA804 Advanced Settings Manual located at <https://www.atlasied.com/Atmosphere/AZA/>

AZA Factory Default UI Settings

- Output Load Selection: CH 1, 2, 3, 4 set to 70V
- Auto Power Down (APD) is Disabled
- Front Panel Power Switch is Enabled

AZA Series

Owner's Manual

Firmware Revision

It may be required to update the firmware on the amp to gain access to feature enhancements or bug fixes. The UI home page contains the firmware revision number installed in the amplifier. Visit <https://www.atlasied.com/Atmosphere/AZA/>, choose the AZA model being updated, and click the "Support Files" tab. Compare the HOST (Hex) file in this section to the firmware version loaded in the AZA amplifier as shown in the image below. If they don't match, download the firmware version that needs to be updated.

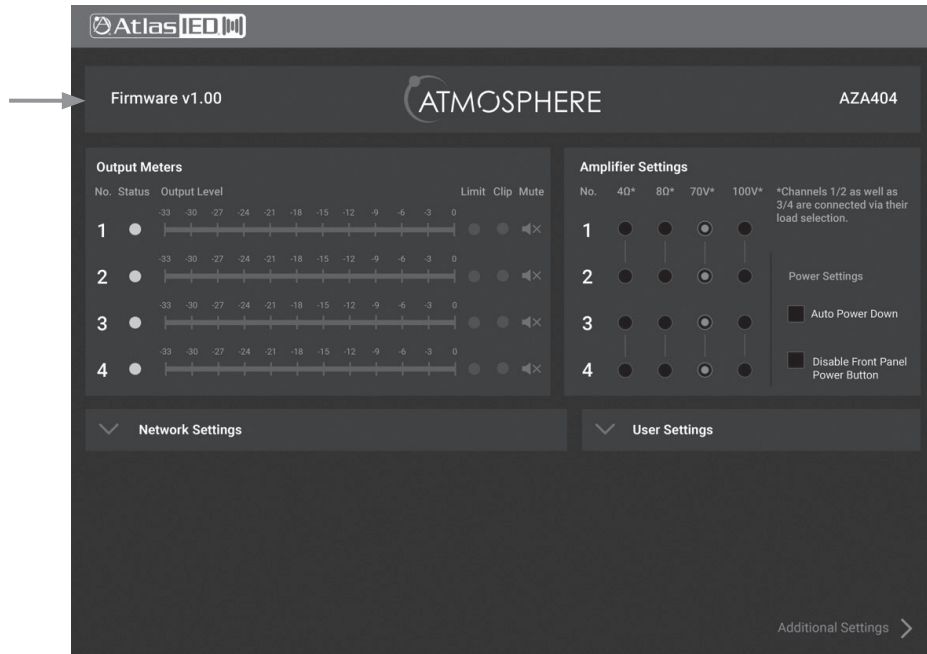

Static IP Addresses

The AZA amplifier factory default mode is DHCP and can be changed to be assigned a static IP address. Click on the Network Setting drop down tab arrow to access the units IP setting. Uncheck the Enable DHCP box to assign a static IP address.

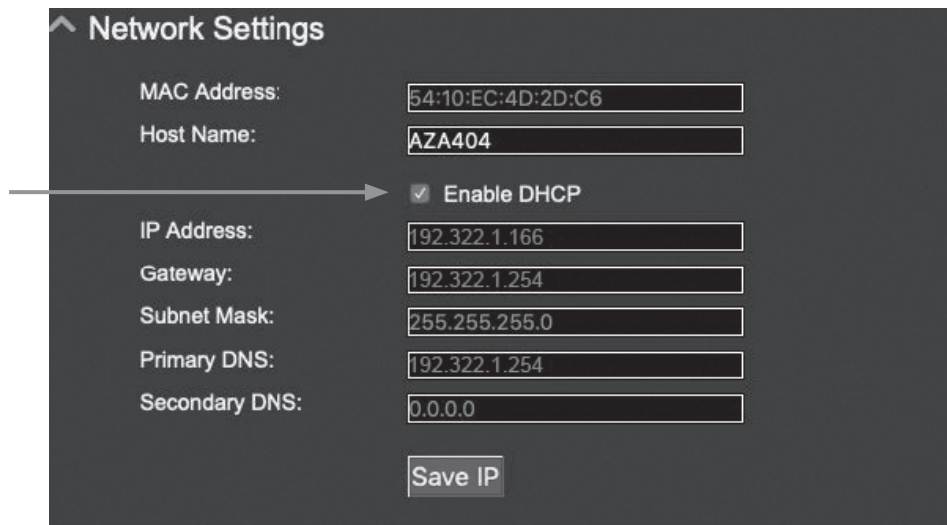

AZA Series

Owner's Manual

Resetting the Amp to DHCP Mode

1. Remove AC power from the AZA amplifier and wait 1 minute.
2. Apply AC power, wait 3 - 5 seconds, then press and hold the front power button for 5 seconds. The power LED will illuminate solid, then all of the front panel LEDs will start to blink rapidly. Release the power switch. You are able to log in once the LEDs stop blinking.
3. DHCP will be reset and both the username and password will be reset to "admin". **Note:** The DSP settings will not be affected.
4. Follow standard login procedures.

Resetting the Login Username & Password

Follow the procedures above for "Resetting the Amp Back to DHCP Mode" During login enter 'admin' for both Username and Password. **Note:** At that time, you be prompted to change the password. **Note:** The Host Name will also be changed back to matching the model number.

Changing the Amplifier (Host) Name

The amplifier name is also known as the Host name. In most applications it is the same as the model number. There are applications where there can be several AZA amplifiers on the same network making it hard to identify. Each amplifier can have a custom name given to it making it easier locating it on a network. This is called the Host name. The Host Name can be changed In the AZA UI Home page Network Settings section. Changing the Host name is useful when using the AZA Amplifier Discovery Software.

Accessory Card Installation

The AZA404 and AZA804 offer four (4) additional inputs that can be routed to any of the four (4) output channels. The optional DPA-DAC4 accessory card offers 4-channels of Dante™ digital audio. Contact AtlasIED for a list of available accessory cards. **Note:** Accessory card installation must be done by a qualified technician.

1. Remove the AZA amplifier from the AC Mains source.
2. Remove the two screws (M3 x 8mm Pan Head Black) holding the AZA accessory blank panel.
3. Remove the ribbon cable from the cover plate.
4. Connect the accessory card to the ribbon cable by carefully aligning the ribbon cable connector to the mating PCB connector. Do not force. When aligned correctly the cable will mate easily.
5. Carefully guide the accessory card into the slot without forcing the PCB or cable.
6. After the card is inserted and the accessory panel is flush to the chassis, align the two (2) screws holes and secure them using the M3 x 8mm screws.

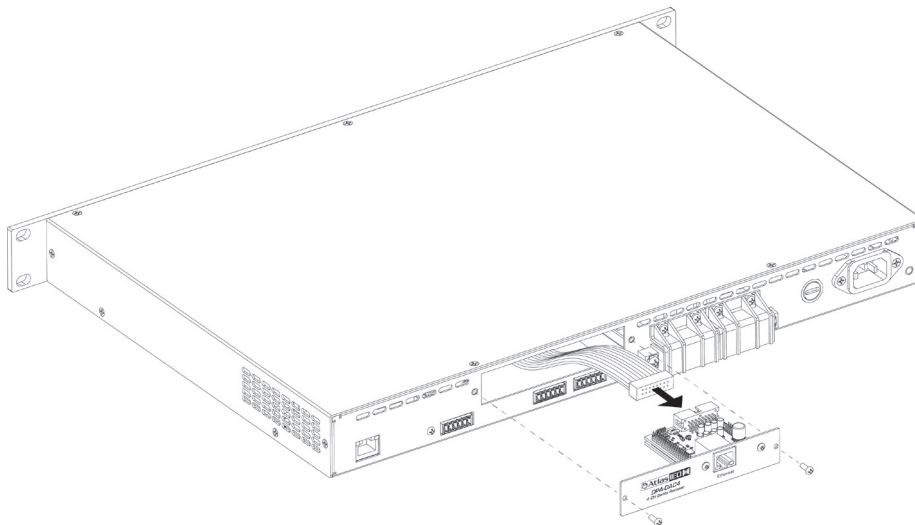

AZA Series

Owner's Manual

Installation and Considerations

Cabling - These amplifiers can be used with either balanced or unbalanced sources, provided the proper cabling is used. A balanced line is defined as two-conductor shielded cable with the two center conductors carrying the same signal but of opposite polarity when referenced to ground. An unbalanced line is generally a single-conductor shielded cable with the center conductor carrying the signal and the shield at ground potential.

Balanced Input - Use 20 - 22 gauge, 2-conductor shielded wire for low level signals. Maintain the proper polarity, + to +, - to - and shield to ground. For unbalanced signals using the phoenix connector, connect the (-) pin of the amplifier input to the GND center pin and the (+) pin to positive.

Speaker Outputs - Use 2-conductor unshielded wire of the appropriate gauge. The AZA Series is approved for Class 3 wiring. Contact AtlasIED Tech Support at 1-800-876-3333 for questions regarding wiring.

Placement And Mounting - Turn off all equipment before making connections. The amplifier can be mounted in a standard width 19" rack. It can be mounted above or below anything that does not generate excessive heat. Although the unit's chassis is shielded against radio frequency (RF) and electromagnetic interference (EMI), extremely high fields of RF and EMI should be avoided.

Ventilation - The amplifier should be situated so that its location or position does not interfere with proper ventilation. For example, the AZA Series amplifiers should not be situated in a sealed cabinet or on a shelf with obstacles that may impede the air flow through the ventilation openings.

Heat - The DPA Series amplifiers should be installed away from heat sources such as radiators, heat registers, stoves, or other appliances (including amplifiers) that produce excessive heat. Ambient temperatures should not exceed 113° F (45°C)

AZA Series

Owner's Manual

System		
Type	4-Channel Configurable Network Digital Commercial Power Amplifier	
Power Supply Type	Global Switch Mode	
Amp Topology	Class AB Hybrid-BASH	
Number of Fixed Inputs	4	
Accessory Inputs	4 (Optional Accessory Card Required)	
DSP Internal	Yes	
Network	Ethernet	
Optional Card Slot	Yes x 1	
Output Power (Note 1)	AZA404	AZA804
100V x 4 CH	100W	200W
70V x 4 CH (Factory Default)	100W	200W
8Ω x 4 CH	75W	150W
4Ω x 4 CH	50W	100W
2Ω x 4 CH	NA	NA
8Ω Bridge	NA	NA
4Ω Bridge	NA	NA
100V x 1 + 8Ω x 2CH	100W / 75W	200W / 150W
70V x 1 + 8Ω x 2CH	100W / 75W	200W / 150W
100V x 1 + 4Ω x 2 CH	100W / 50W	200W / 100W
70V x 1 + 4Ω x 2 CH	100W / 50W	200W / 100W
Factory Default Settings (As Shipped)		
Amplifier Configuration	4 CH 70V Mode	
Level Controls Assignment	Front Panel	
I/O Matrix	Input 1 Routed to Output 1, Input 2 to Output 2, Input 3 to Output 3, Input 4 to Output 4	
Level Position	DSP Set to 0dBu	
EQ & Filters	DSP High Pass Filers Set to -3dB 20Hz, EQ Filters Flat	
Limiter	0dB (Max Power)	
GPIO Control Ports (Rear Panel)	Remote Level, C1 Assigned to Output 1, C2 to Output 2, C3 to Output 3, C4 to Output 4	
Auto Power Down (APD)	Disabled	
Inputs		
Input Quantity	4 Balanced Inputs, Expandable to 8 via Dante Accessory Card	
Input Type (Line Balanced or Unbalanced)	Balanced	
Input Impedance	40kΩ	
Input Sensitivity	750mV Balanced, 0dBu	
Maximum Input Level dBu & Vrms	14dBu, 3.82V	
Input Connectors Type	3.5mm Euro Block	
Accessory Slot	4 Input Dante™ Digital Card (DPA-DAC4)	
Level Control		
GUI Control	PC (Requires Ethernet Cable), iPhone®, Android® Using a Standard Web Browser	

AZA Series

Owner's Manual

Status Indicators	
Power	Blue
Standby (Remote Turn ON)	Blinking Blue, Front Panel Only
Output Signal	Green
LED Bar Meter	GUI Only
Output Limit / Protect	Red
4Ω / 8Ω	Yellow, CH 1/2 & CH 3/4
70V / 100V Operation	Yellow, CH 1/2 & CH 3/4
Output Mute Status	Flashing Red
DSP Elements	
IO Routing	Matrix Mixer
Hi & Low Pass Filters	One Per Output, Adjustable Slopes and Frequencies
EQ	5 Parametric Filters Per Output
Delay	60mS Per Output
Limiter	Each Output up to 12dB of Assignable Limiting
DSP Frequency Type	48k, 24bit
Interface Control Ports	
USB	No
Ethernet	GUI Access, RJ45 Rear Panel
Wi-Fi	No
Bluetooth	No
GPIO Ports	
Location	Rear
GPIO Ports	Qty 4, Remote Level & Mute Functions, Assignable, PHX Connector
Connection	Euro Block PHX Type 3.5mm, 6 Pins, Ground, +10VDC, C1, C2, C3, C4
Functions	Mute, Remote Level (Assignable)
Output Terminals (Speaker)	
Output Connectors Type	Screw Terminal Barrier Strip with Cover
Output Connectors Number of Terminals	8, M4 Thread
Output Connectors Fixed or Removable	Fixed
Wire Size	18-10 AWG When Using Yellow Spade Lug 0.250 Terminal, Qty 8 Included (Class 3 Wiring Required)
Terminal Spacing	0.300" (7.62mm)
Current Rating	25A per Terminal
Cooling	
APD Standby, Active Idle	Convection Cooled
In Use	Convection Cooled with Variable Speed Fan Assist
Cooling Air Flow Direction	Rear to Front
Electrical Specifications (General)	
Total Harmonic Distortion 1 kHz and 1dB Below Rated Power	Typical, 0.2%
Frequency Response	20Hz - 20kHz (DSP Filters Set to Flat)
Signal to Noise Ratio	>100dB Below Rated Output (A-weighted)
Damping Factor (20Hz to 400Hz)	100 (Measurement is Limited Due To DSP)
Slew Rate	40Vus
Crosstalk	73dB @ 1KHz, CH1-2 & CH 2-1, CH3-4 & CH4-3
Protection	Hi / Low Input Voltage, Thermal, Short, Over Current
Max Output Peak Voltage 100V Mode	140V
Max Output Peak 4Ω Mode	AZA404: 3.5A AZA804: 7A

AZA Series

Owner's Manual

AC Power Requirements			
Operating Voltage	110V - 120V & 220V - 230V 50/60Hz, Auto Voltage Sense		
Mains Interface	IEC 15A Receptacle		
Power Cord (Included)	1.5m, IEC C13 to NEMA 5-15P Plug, 18AWG		
Minimum Power-Up Voltage	90V		
Maximum Operating Voltage	264V		
Recommended AC Mains Current Requirements	AZA404: 2.7A (Speech & Background Music), 8.2A (Max Usage) AZA804: 5.3A (Speech & Background Music), 15A (Max Usage)		
AZA404			
Power Consumption / Current Draw (Note 5)	Amps	Watts	BTU / hr (Note 4)
Sleep Mode	90mA	4W	12 BTU
Standby / APD Mode (Note 2)	225mA	18W	56 BTU
Idle Active Mode (Note 2)	650mA	40W	126 BTU
Average Power 4Ω, All Channels Driven (Note 3)	2.2A	160W	504 BTU
Average Power 70V, All Channels Driven (Note 3)	2.7A	215W	648 BTU
Max Power 4Ω, All Channels Driven (Note 4)	6.1A	486W	1479 BTU
Max Power 70V, All Channels Driven (Note 4)	8.2A	710W	2079 BTU
AZA804			
Power Consumption / Current Draw (Note 5)	Amps	Watts	BTU / hr (Note 4)
Sleep Mode	90mA	4W	12 BTU
Standby / APD Mode (Note 2)	225mA	18W	56 BTU
Idle Active Mode (Note 2)	650mA	40W	126 BTU
Average Power 4Ω, All Channels Driven (Note 3)	3.7A	270W	964 BTU
Average Power 70V, All Channels Driven (Note 3)	5.3A	425W	1280 BTU
Max Power 4Ω, All Channels Driven (Note 4)	9.5A	794W	2369 BTU
Max Power 70V, All Channels Driven (Note 4)	15.9A	1362W	3692 BTU
Dimensions and Weight			
Rack Mount Requirements	1 RU, 19"		
Dimensions - Unit	W 19" x H 1.77" x D 15.5" (483mm x 45mm x 394mm)		
Dimensions - Shipping	W 24.5" x H 3.5" x D 18.7" (635mm x 89mm x 477mm)		
Weight - Unit	13 lbs. (5.92kg)		
Weight - Shipping	17.4 lbs (7.94kg)		
Agency Approvals			
North America Agency	TUV		
Testing Standard North America	60065		
FCC Class A (Conducted & Radiated Emissions)	Part 15 of the FCC Rules		
RoHS / WEEE Compliant	Yes		
CE	Yes		
Optional Accessories			
AZA IP Discovery Software	Yes		
DPA-DAC4	4 CH Dante™ Receiver		
DPA-AMIX	(2) Mic / Line, (2) AUX Input Card		

Notes:

1. Power level measurement is defined as follows: 1KHz Sine wave signal burst of 20 cycles (20mS) at 1% THD+N, followed by 480 cycles of a 1kHz sine wave at 10% of the max power. Other power measurements are available upon requests.
2. Power measurement with Ethernet connected. Without Ethernet connected deduct 0.2W
3. Average Power is defined as Pink Noise input signal applied to achieve 1/4 of the 4 Ohm or 70.7V power rating.
4. Max Power is defined as 1 KHz input signal applied to achieve the maximum power output before clipping into a 4 Ohm or 70.7V load.
5. BTU is calculated by the AC Mains Power consumed minus the total power output measured at the specified load and condition, multiplied by 3.412. Example: 785 Watts from the AC Source - 600 Watts Total Output power = 185 x 3.412 = 631 BTU

AZA Series

Owner's Manual

Dimensional Drawings

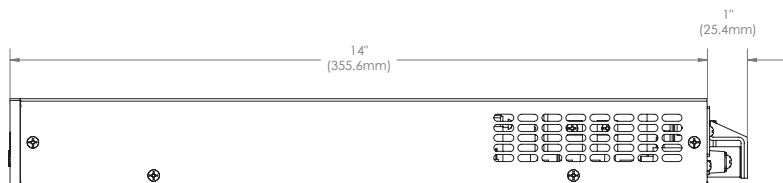
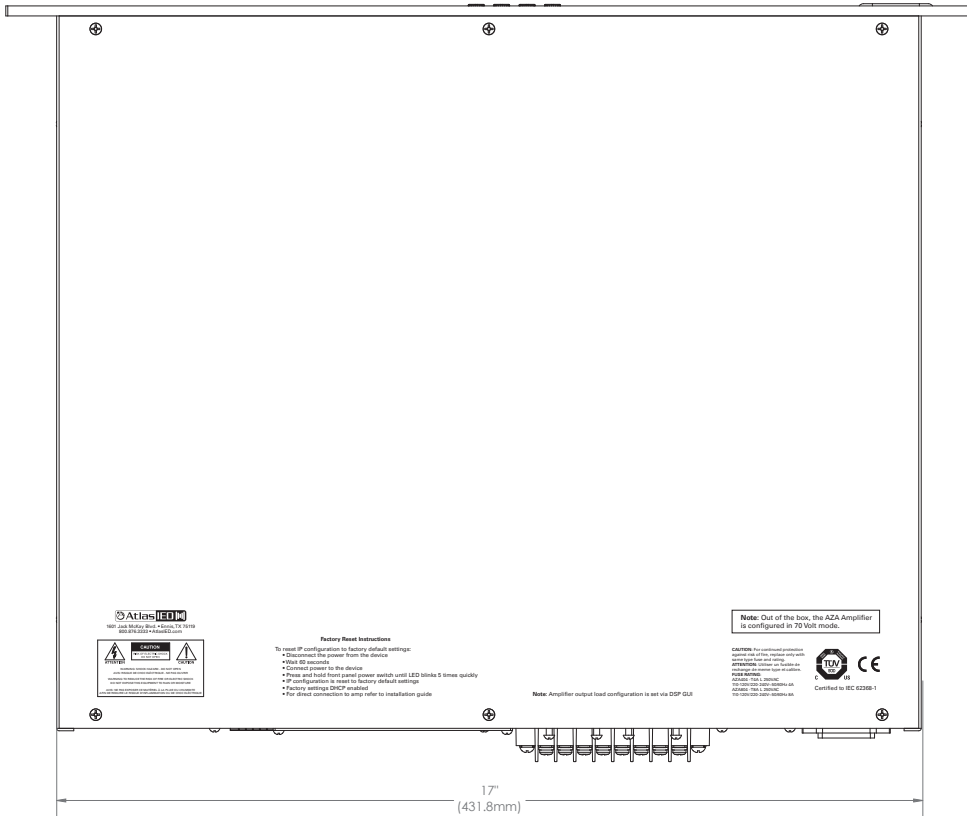
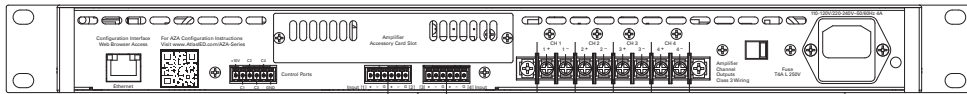
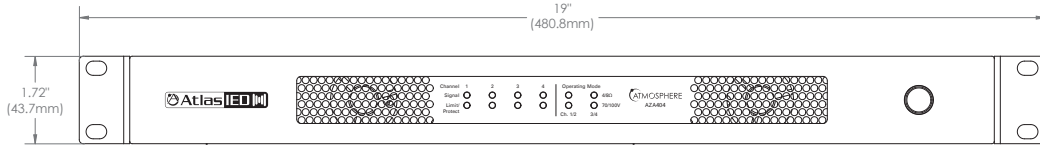

Limited Warranty

All products manufactured by AtlasIED are warranted to the original dealer/installer, industrial or commercial purchaser to be free from defects in material and workmanship and to be in compliance with our published specifications, if any. This warranty shall extend from the date of purchase for a period of three years on all AtlasIED products, including SOUNDOLIER brand, and ATLAS SOUND brand products except as follows: one year on electronics and control systems; one year on replacement parts; and one year on Musician Series stands and related accessories. Additionally, fuses and lamps carry no warranty. AtlasIED will solely at its discretion, replace at no charge or repair free of charge defective parts or products when the product has been applied and used in accordance with our published operation and installation instructions. We will not be responsible for defects caused by improper storage, misuse (including failure to provide reasonable and necessary maintenance), accident, abnormal atmospheres, water immersion, lightning discharge, or malfunctions when products have been modified or operated in excess of rated power, altered, serviced or installed in other than a workman like manner. The original sales invoice should be retained as evidence of purchase under the terms of this warranty. All warranty returns must comply with our returns policy set forth below. When products returned to AtlasIED do not qualify for repair or replacement under our warranty, repairs may be performed at prevailing costs for material and labor unless there is included with the returned product(s) a written request for an estimate of repair costs before any nonwarranty work is performed. In the event of replacement or upon completion of repairs, return shipment will be made with the transportation charges collect.

EXCEPT TO THE EXTENT THAT APPLICABLE LAW PREVENTS THE LIMITATION OF CONSEQUENTIAL DAMAGES FOR PERSONAL INJURY, ATLASIED SHALL NOT BE LIABLE IN TORT OR CONTRACT FOR ANY DIRECT, CONSEQUENTIAL OR INCIDENTAL LOSS OR DAMAGE ARISING OUT OF THE INSTALLATION, USE OR INABILITY TO USE THE PRODUCTS. THE ABOVE WARRANTY IS IN LIEU OF ALL OTHER WARRANTIES INCLUDING BUT NOT LIMITED TO WARRANTIES OF MERCHANTABILITY AND FITNESS FOR A PARTICULAR PURPOSE.

AtlasIED does not assume, or does it authorize any other person to assume or extend on its behalf, any other warranty, obligation, or liability. This warranty gives you specific legal rights and you may have other rights which vary from state to state.

Service

Should your AZA Series Amplifier require service, please contact the AtlasIED warranty department at 1-877-689-8055, ext. 277 or www.atlasied.com/support to obtain an RA number.

AtlasIED Tech Support can be reached at 1-800-876-3333 or www.atlasied.com/support.

Visit our website at www.AtlasIED.com to see other AtlasIED products.